



**PLEASE CHECK FOR CHANGE INFORMATION
AT THE REAR OF THIS MANUAL.**

7B92A

DUAL TIME BASE

INSTRUCTION MANUAL

Tektronix, Inc.
P.O. Box 500
Beaverton, Oregon 97077

070-1751-02
Product Group 42

Serial Number _____

First Printing JUN 1978
Revised JUN 1987

TABLE OF CONTENTS

	Page
LIST OF ILLUSTRATIONS	iii
SAFETY SUMMARY	v
SECTION 1 OPERATING INSTRUCTIONS	
INTRODUCTION	1-1
INSTALLATION	1-1
FRONT-PANEL CONTROLS, CONNECTORS, AND INDICATORS	1-2
Main Triggering Controls	1-2
Sweep Controls	1-4
Delayed Triggering Controls	1-5
Front-Panel Inputs	1-5
FUNCTIONAL CHECK	1-5
Setup Procedure	1-6
Sweep Functions	1-6
Triggering Functions	1-7
GENERAL OPERATING INFORMATION	1-8
Main Triggering	1-8
Main Trigger Modes	1-8
Main Trigger Coupling	1-9
Main Trigger Source	1-10
Input Impedance	1-10
Trigger Slope	1-10
Trigger Level	1-10
Selecting Sweep Rates	1-12
Time Measurement	1-12
Display Modes	1-12
Delay Time Multiplier	1-13
Delayed Sweep Triggering	1-13
SECTION 2 SPECIFICATION	2-1
WARNING	
<i>THE FOLLOWING SERVICING INSTRUCTIONS ARE FOR USE BY QUALIFIED PERSONNEL ONLY. TO AVOID PERSONAL INJURY, DO NOT PERFORM ANY SERVICING OTHER THAN THAT CONTAINED IN OPERATING INSTRUCTIONS UNLESS YOU ARE QUALIFIED TO DO SO.</i>	
SECTION 3 THEORY OF OPERATION	
Block Diagram Description	3-1
Detailed Circuit Description	3-1
Main Trigger Generator	3-1
Delaying Sweep Generator	3-3
Delayed Trigger Generator	3-4
Delayed Sweep Generator	3-6
Horizontal Logic	3-6
Output Amplifier	3-7
Readout	3-7

TABLE OF CONTENTS (cont)

SECTION 4	MAINTENANCE	Page
	Preventive Maintenance	4-1
	Cleaning	4-1
	Visual Inspection	4-1
	Lubrication	4-1
	Semiconductor Checks	4-2
	Adjustment After Repair	4-2
	Troubleshooting	4-3
	Troubleshooting Aids	4-3
	Troubleshooting Equipment	4-6
	Troubleshooting Techniques	4-6
	Corrective Maintenance	4-8
	Obtaining Replacement Parts	4-8
	Soldering Techniques	4-8
	Component Removal and Replacement	4-9
	Adjustment After Repair	4-11
	Repackaging For Shipment	4-11
SECTION 5	PERFORMANCE CHECK/CALIBRATION	
	Preliminary Information	5-1
	Test Equipment Required	5-1
	Part I Performance Check	5-4
	Outline for Part I Performance Check	5-6
	A. Trigger Sensitivity	5-4
	B. Horizontal System	5-4
	Preliminary Procedure	5-4
	A. Trigger Sensitivity	5-5
	B. Horizontal System	5-10
	Part II Calibration	5-16
	Outline for Part II Calibration	5-16
	A. Trigger Sensitivity (SN B070000-above)	5-16
	B. Trigger Sensitivity (SN B069999-below)	5-16
	C. Horizontal System	5-17
	Preliminary Procedure	5-17
	A. Trigger Sensitivity (SN B070000-above)	5-18
	B. Trigger Sensitivity (SN B069999-below)	5-25
	C. Horizontal System	5-33
SECTION 6	OPTIONS	
SECTION 7	REPLACEABLE ELECTRICAL PARTS	
SECTION 8	DIAGRAMS AND CIRCUIT BOARD ILLUSTRATIONS	
SECTION 9	REPLACEABLE MECHANICAL PARTS	
Change Information		

LIST OF ILLUSTRATIONS

Figure No.		Page
Frontispiece	7B92A Dual Time Base	
1-1	Location of Variable and Mainframe Selector multi-pin connectors.	1-1
1-2	Location of release latch.	1-2
1-3	Front-panel controls and connectors.	1-3
1-4	Effect of MAIN TRIGGERING LEVEL and SLOPE controls on crt display. . .	1-11
1-5	Area of graticule used for most accurate time measurements.	1-12
1-6	Typical alternate sweep display.	1-13
2-1	Dimensional drawing.	2-5
4-1	Lubrication procedure for a typical cam switch.	4-2
4-2	Semiconductor lead configurations.	4-4
4-3	Inter-board multi-pin connector assembly.	4-5
4-4	End-lead multi-pin connector assembly.	4-5
4-5	Location of pin numbers of Interface connector.	4-5
5-1	Main Triggering level range.	5-6
5-2	Delayed Triggering level range.	5-6
5-3	Variable Time/Division range.	5-13
5-4	Fast delay time accuracy.	5-14
5-4A	AC HF REJ Balance	5-19
5-5	DC balance. (Circle denotes correct trigger point.)	5-19
5-6	Trigger Sensitivity. (Circle denotes correct trigger point.)	5-19
5-7	Main Triggering level range. (Circle denotes triggering limits.)	5-19
5-8	Delayed Triggering level range. (Circle denotes triggering limits.)	5-21
5-9	DC balance. (Circle denotes correct trigger point.)	5-26
5-10	Trigger sensitivity. (Circle denotes correct trigger point.)	5-26
5-11	Main Triggering level range. (Circle denotes triggering limits.)	5-27
5-12	Delayed Triggering level range. (Circle denotes triggering limits.)	5-29
5-13	Correct DTM Scale and Delay Start adjustment (circle).	5-34
5-14	Variable Time/Division range.	5-38
5-15	Fast delay time accuracy.	5-39

LIST OF ILLUSTRATIONS (cont)

The illustrations in Section 8 are located near their associated diagrams on the foldout pages.

Figure No.

8-1	Circuit board locations
8-2	Block diagram
8-3	A3 Coupling Switch circuit board
8-4	A5 Delayed Triggering Switch circuit board
8-5	A2 Source Switch circuit board
8-6	A4 Mode Switch circuit board
8-7	A1 External Input circuit board
8-8	A8 Main Trigger circuit board (SN B070000-above)
8-9	A8 Main Trigger circuit board (SN B069999-below)
8-10	A9 Delayed Trigger circuit board (SN B096951-above)
8-11	A9 Delayed Trigger circuit board (SN B70000-B096950)
8-12	A9 Delayed Trigger circuit board (SN B069999-below)
8-13	A6 Interface circuit board (SN B095741-above)
8-14	A6 Interface circuit board (SN B095740-below)
8-15	A7 Logic circuit board (SN B059999-below)
8-16	A7 Logic circuit board (SN B060000-above)
8-17	A12 Readout circuit board
8-18	Location of Sweep Timing adjustments
8-19	Location of Main Trigger adjustments (SN B069999-below)
8-20	Location of Delayed Trigger adjustments (SN B069999-below)
8-21	Location of Main Trigger adjustments (SN B070000-above)
8-22	Location of Delayed Trigger adjustments (SN B070000-above)

SAFETY SUMMARY

This manual contains safety information that the user must follow to ensure safe operation of this instrument. WARNING information is intended to protect the operator; CAUTION information is intended to protect the instrument. The following are general safety precautions that must be observed during all phases of operation and maintenance.

WARNING

Ground the Instrument

To reduce electrical-shock hazard, the mainframe (oscilloscope) chassis must be properly grounded. Refer to the mainframe manual for grounding information.

Do Not Operate in Explosive Atmosphere

Do not operate this instrument in an area where flammable gases or fumes are present. Such operation could cause an explosion.

Avoid Live Circuits

Electrical-shock hazards are present in this instrument. The protective instrument covers must not be removed by operating personnel. Component replacement and internal adjustments must be referred to qualified service personnel.

Do Not Service or Adjust Alone

Do not service or make internal adjustments to this instrument unless another person, capable of giving first aid and resuscitation, is present.

WARNING

Warning Statements

Warning statements accompany potentially dangerous procedures in this manual. The following warnings appear in this manual and are listed here for additional emphasis.

To avoid electrical shock, disconnect the instrument from the power source before soldering.

To avoid electrical shock, disconnect the instrument from the power source before replacing components.

Handle silicone grease with care. Avoid getting silicone grease in eyes. Wash hands thoroughly after use.

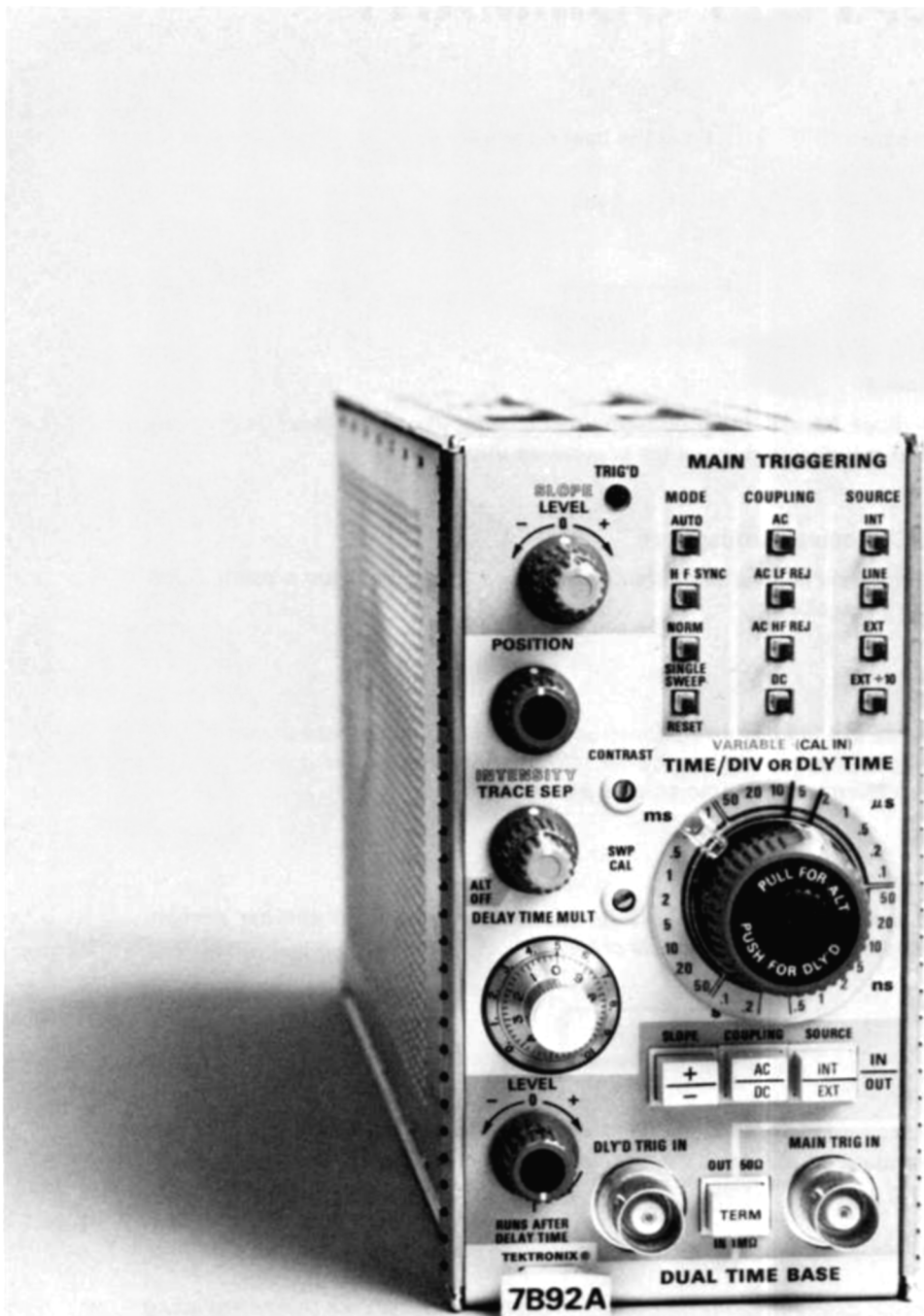

OPERATING INSTRUCTIONS

INTRODUCTION

The 7B92A Dual Time Base unit provides normal, delayed, intensified, and alternate sweep operation for TEKTRONIX 7000-Series Oscilloscopes. Calibrated sweep rates from 0.2 second to 0.5 nanosecond and triggering to 500 megahertz are provided. The 7B92A is intended for use with high-frequency 7000-Series Oscilloscope systems; however, most 7B92A functions are compatible with all 7000-Series Oscilloscopes.

Other features include lighted pushbutton switches, compatibility with indicator oscilloscopes having an alphanumeric readout system, and 0 to 9.8 times continuous sweep delay. A VARIABLE control allows continuously variable sweep rates between calibrated steps. Also, when operating in the AUTO MAIN TRIGGERING Mode, a bright base line is displayed in the absence of a trigger signal.

This section describes the operation of the front-panel controls and connectors, and provides a functional check and general operating information for this instrument.

NOTE

The ALT OFF position, which allows the Intensified mode of operation, is applicable to instruments SN B060000-above.

INSTALLATION

The 7B92A is designed to operate in the horizontal plug-in compartment of the oscilloscope. This instrument can also be installed in a vertical plug-in compartment to provide a vertical sweep on the crt. However, when used in this manner, there are no internal triggering or retrace blanking provisions, and the unit may not meet the specifications given in the Specification section of this manual.

Before proceeding with installation, check the settings of the Time/Div Variable Selector multi-pin connector and the Mainframe Selector multi-pin connector (see Fig. 1-1). The Time/Div Variable Selector determines whether the front-panel Time/Div VARIABLE control operates in conjunction with the delaying or delayed sweeps. The Mainframe Selector adapts the 7B92A to the oscilloscope mainframe being used. The two mainframe selections are:

1. 7800 and 7900-Series Oscilloscopes.
2. All other 7000-Series Oscilloscopes.

NOTE

The 7B71 will not delay the 7B92A for displaying alternating Delaying and Delayed sweeps. Instead, it causes a sweep lock-up to occur under the following conditions; with the 7B71 in the A horizontal com-

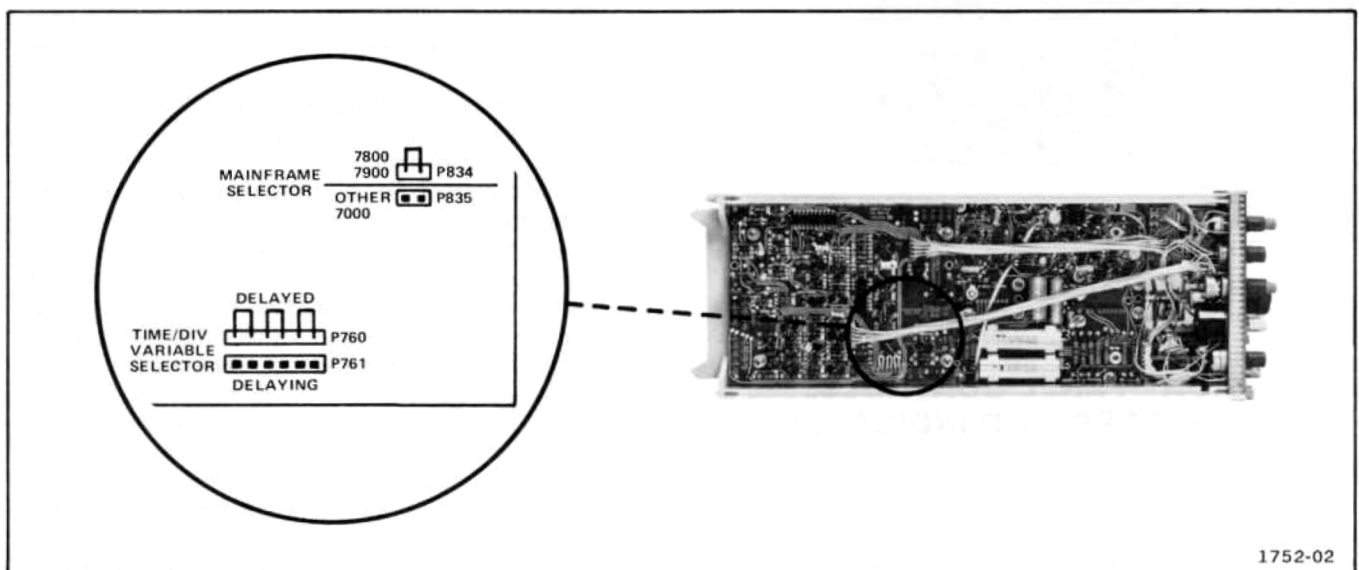

Fig. 1-1. Location of Variable and Mainframe Selector multi-pin connectors.

Operating Instructions—7B92A

partment and the 7B92A in the B horizontal compartment, the sweep locks up if the 7B92A is in its Alternate mode and the Mainframe Horizontal mode is Alt. Lock-up can be avoided by changing the Mainframe Horizontal mode to Chop or B. This allows both 7B92A sweeps to be displayed.

To install the 7B92A in a plug-in compartment, push it in until it fits firmly into the compartment. The front panel of the 7B92A should be flush with the front panel of the oscilloscope. Even though the gain of the oscilloscope is standardized, the sweep calibration of the 7B92A should be checked when installed. The procedure for checking the unit is given under Sweep Calibration in the Operating Checkout procedure in this section.

To remove the 7B92A, pull the release latch (see Fig. 1-2) to disengage the unit from the oscilloscope, and pull it out of the plug-in compartment.

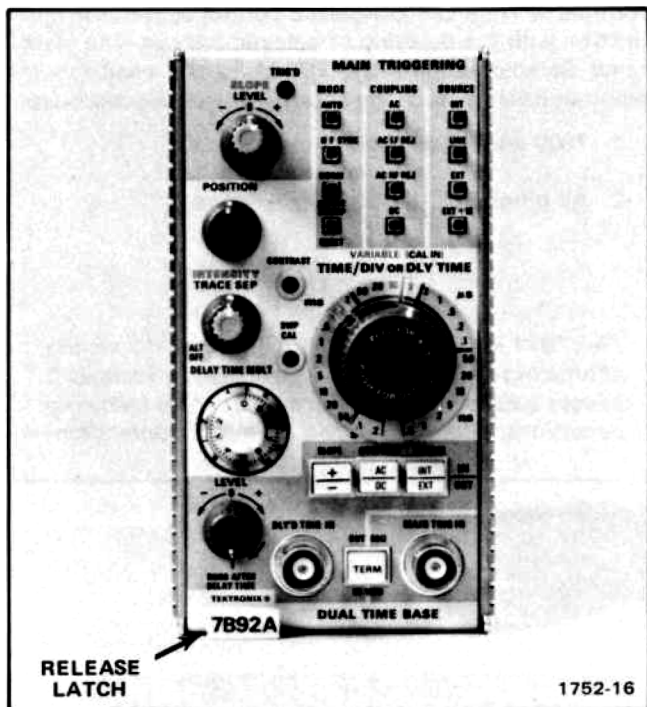

Fig. 1-2. Location of release latch.

FRONT-PANEL CONTROLS, CONNECTORS, AND INDICATORS

All controls, connectors, and indicators required for the operation of the 7B92A, except the Time/Div Variable and Mainframe Selectors, are located on the front panel. A brief description of the front-panel controls, connectors, and indicators is given here. More detailed information is given under General Operating Information. Fig. 1-1

shows the Time/Div Variable and Mainframe Selectors. Fig. 1-3 shows the front-panel controls, connectors, and indicators.

MAIN TRIGGERING Controls

① LEVEL Control

Selects amplitude point on trigger signal where sweep triggering occurs when the MAIN TRIGGERING MODE AUTO, NORM, or SINGLE SWEEP switches are pressed. When the MAIN TRIGGERING MODE HF SYNC switch is pressed, the LEVEL control adjusts the frequency of the trigger generator to synchronize with the frequency (or sub-harmonic) of the triggering signal to provide a stable display.

② SLOPE Control

Permits triggering on the positive or negative slope of the trigger signal (except in HF SYNC).

③ TRIG'D Indicator

When lit, indicates that the sweep is triggered and will produce a display with correct setting of the POSITION control and the controls on the associated amplifier plug-in unit(s) and oscilloscope.

④ MODE Switches

Select the desired MAIN TRIGGERING mode. Selected mode is indicated by lighted pushbutton.

AUTO: Selects a triggered sweep initiated by the applied trigger signal at a point determined by the LEVEL control and SLOPE control when the trigger signal repetition rate is above 30 hertz and within the frequency range selected by the COUPLING switches. When the LEVEL control is outside the amplitude range, the trigger repetition rate is outside the frequency range selected by the COUPLING switches, or the trigger signal is inadequate, the sweep free-runs to provide a reference trace.

HF SYNC: Sweep initiated by trigger signals with repetition rates above 100 megahertz and within the range selected by the COUPLING switch. Stable display can be obtained when the LEVEL control adjusts the frequency of the trigger generator to the frequency (or sub-harmonic) of the trigger signal. When the LEVEL control is adjusted to frequencies between sub-harmonics, the sweep free-runs.

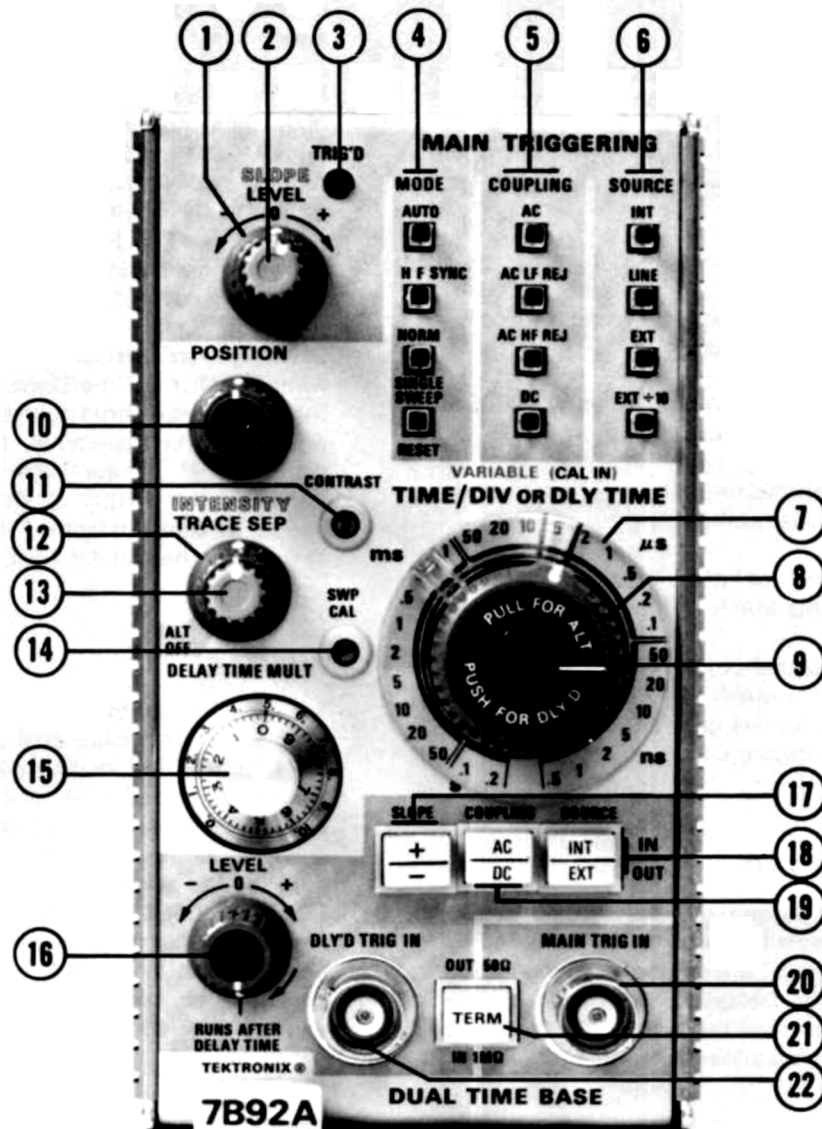

Fig. 1-3. Front-panel controls and connectors.

NORM: Sweep initiated by the applied trigger signal at a point selected by the LEVEL control and SLOPE control over the frequency range selected by the COUPLING switches. Triggered sweep can be obtained only over the amplitude range of the applied trigger signal. When the LEVEL control is either outside the amplitude range, the trigger repetition rate is outside the frequency range selected by the COUPLING switches, or the trigger signal is inadequate, there is no trace.

SINGLE SWEEP-RESET: When the SINGLE SWEEP-RESET switch is pressed, a single trace will be presented when the next trigger pulse is received. The SINGLE SWEEP-RESET switch remains lit until

a trigger is received and the sweep is completed. The SINGLE SWEEP-RESET switch must be pressed again before another sweep can be displayed.

5 COUPLING Switches

Select trigger signal coupling. Selected coupling is indicated by lighted pushbutton.

AC: Rejects dc and attenuates ac signals below about 30 hertz. Accepts signals between 30 hertz and 500 megahertz.

Operating Instructions—7B92A

AC LF REJ: Rejects dc and attenuates signals below 30 kilohertz. Accepts signals between 30 kilohertz and 500 megahertz.

AC HF REJ: Rejects dc and attenuates signals above 50 kilohertz. Accepts signals from 30 hertz to 50 kilohertz.

DC: Accepts all signals from dc to 500 megahertz.

6 SOURCE Switches

Select the triggering source. Selected source is indicated by lighted pushbutton.

INT: Trigger signal obtained internally from amplifier plug-in unit of oscilloscope.

LINE: Trigger signal obtained internally from the line voltage applied to the oscilloscope.

EXT: Trigger signal obtained from an external source applied to the MAIN TRIG IN connector.

EXT ÷10: Trigger signal obtained from an external source applied to the MAIN TRIG IN connector. In this position, the external signal is attenuated before it is applied to the trigger circuit.

Sweep Controls

7 TIME/DIV OR DLY TIME

Selects the basic sweep rate for normal sweep operation and selects the delay time (multiplied by the DELAY TIME MULT dial setting) when operating in the Alternate or Delayed sweep modes. The VARIABLE control must be in the CAL (knob in) position for calibrated sweep rate.

8 DLY'D Time/Division

Selects the delayed sweep rate for operation in Delayed and Alternate sweep modes. The VARIABLE control must be in the CAL (knob in) position for calibrated sweep rate.

Four display modes can be selected by the following switch settings:

Normal Sweep: A normal sweep is selected when the TIME/DIV OR DLY TIME switch and the DLY'D Time/Division switches are locked together at the same sweep rate. The DLY'D Time/Division knob must be pressed in for normal sweep mode. Calibrated sweep rates from 0.2 second/division to 0.5 nanosecond/division can be selected

ALT Sweep: The Alternate mode is selected when the DLY'D Time/Division switch is pulled out and rotated clockwise and the TRACE SEP control is

turned clockwise from the ALT OFF position. In this mode, the delaying sweep is displayed (with an intensified zone during the time that the delayed sweep runs) alternately with the delayed sweep.

Intensified Sweep: The Intensified mode, a function of the delaying and delayed sweeps is selected when the DLY'D Time/Division switch is pulled out and rotated clockwise, and the TRACE SEP control is rotated fully counterclockwise to the ALT OFF position (see Fig. 1-3). In this mode, a portion of the delaying sweep is intensified during the time that the delayed sweep generator runs.

DLY'D Sweep: The Delayed sweep mode is selected when the DLY'D Time/Division switch is pulled out, rotated for the desired delayed sweep rate, and then pushed in. In this mode, the delayed sweep is displayed at a rate determined by the DLY'D Time/Division switch at the end of each delay period, as selected by the TIME/DIV OR DLY TIME switch and the DELAY TIME MULT dial setting.

9 VARIABLE

Two-position switch actuated by the VARIABLE control to select calibrated or uncalibrated sweep rates. In the CAL position (knob in) the VARIABLE control is inoperative and the sweep rate is calibrated. When pressed and released, the knob moves out to activate the VARIABLE control for uncalibrated sweep rates. The sweep rate in each TIME/DIV OR DLY TIME switch position can be reduced at least to the sweep rate of the next slower position. The VARIABLE control will operate with either the delaying or delayed sweep by means of the internal Time/Div Variable Selector.

10 POSITION Control

Positions the display horizontally on the graticule.

11 CONTRAST Adjustment

Varies the relative brightness of the intensified portion of the delaying trace when in the Alternate mode.

12 TRACE SEP/ALT OFF Control

This control vertically positions the delaying sweep display up to 3.5 divisions above the delayed sweep display when in the Alternate mode. The ALT OFF position allows the Intensified sweep mode of operation, permitting the display of an intensified portion of the delaying sweep.

- ⑬ INTENSITY Control
Varies the intensity of the Intensified sweep only, when operating in the Intensified or Alternate mode (must be set near clockwise end when 7B92A is operating in some 7000-Series Oscilloscopes).

- ⑭ SWP CAL Adjustment
Screwdriver adjustment sets the basic timing of the 7B92A to compensate for slight differences in input sensitivity when changing indicator oscilloscopes.

- ⑮ DELAY TIME MULT Dial
Provides variable delay of 0 to 9.8 times the basic delay time selected by the TIME/DIV OR DLY TIME switch.

Delayed Triggering Controls

- ⑯ LEVEL Control
Determines the delayed trigger mode and the delayed trigger level.

RUNS AFTER DELAY TIME (LEVEL control turned fully clockwise into detent): Delayed sweep runs immediately following the delay time selected by the TIME/DIV OR DLY TIME switch and the DELAY TIME MULT dial. Delayed Slope, Coupling, and Source functions are inoperative.

Delayed Sweep Triggerable: When the Delayed Triggering LEVEL control is turned counterclockwise out of detent, the delayed sweep is triggerable. The Delayed Triggering LEVEL control can now be rotated to select the amplitude point on the trigger signal at which the delayed sweep is triggered. In the Delayed Sweep Triggerable mode, the delayed Slope, Coupling, and Source functions are activated.

- ⑰ SLOPE Switch
Two-position pushbutton switch to select the slope of the trigger signal which starts the delayed sweep.

+: The delayed sweep can be triggered on the positive slope of the trigger signal.

—: The delayed sweep can be triggered on the negative slope of the trigger signal.

- ⑱ SOURCE Switch
Two-position pushbutton switch to select the source of the delayed trigger signal.

INT: The delayed trigger signal is obtained from the vertical amplifier of the oscilloscope.

EXT: The delayed trigger signal is obtained from an external source connected to the DLY'D TRIG IN connector.

- ⑲ COUPLING Switch
Two-position pushbutton switch to determine the method of coupling the trigger signal to the delayed trigger circuit.

AC: Rejects dc and attenuates signals below 30 hertz. Accepts trigger signals from 30 hertz to 500 megahertz.

DC: Accepts trigger signals from dc to 500 megahertz.

Front-Panel Inputs

- ⑳ MAIN TRIG IN Connector
Serves as an external trigger input for the main triggering circuit when the MAIN TRIGGERING SOURCE EXT or EXT ÷ 10 pushbutton switches are pressed.

- ㉑ TERM Switch
Two-position pushbutton switch to select 50 ohms (out position) or 1 megohm (in position) input impedance for the MAIN TRIG IN and DLY'D TRIG IN connectors.

DLY'D TRIG IN Connector

Serves as an external trigger input for the delayed triggering circuit when the Delayed Triggering SOURCE switch is set to EXT.



Do not exceed 7 volts (rms) of external signal when 50 Ω termination is selected.

FUNCTIONAL CHECK

The following procedures may be used for familiarization or as a check of basic instrument operation. The procedure is divided into two parts, Sweep Functions and Triggering Functions. A complete operating check of the 7B92A functions can be made by performing both parts, or each part may be performed separately. If performing the functional check procedure reveals a malfunction or

Operating Instructions—7B92A

possible improper adjustment; first check the operation of the associated plug-in units, then refer to the instruction manual for maintenance and adjustment procedures.

NOTE

For optimum high-frequency performance, the 7B92A should be installed in an oscilloscope system with similar frequency and sweep-rate capabilities.

Setup Procedure

1. Install the 7B92A in a horizontal compartment of the oscilloscope.
2. Install the amplifier plug-in unit in a vertical compartment.
3. Turn on the oscilloscope and allow at least 20 minutes warm up.
4. Set the 7B92A controls as follows:

MAIN TRIGGERING

SLOPE	(+)
MODE	AUTO
COUPLING	AC
SOURCE	INT

Delayed Triggering

LEVEL	RUNS AFTER DELAY TIME
SLOPE	(+)
COUPLING	AC
SOURCE	INT

Sweep Controls

POSITION	Midrange
INTENSITY	As desired
TIME/DIV OR DLY TIME	1 ms
DLY'D Time/Division	1 ms (knob in)
VARIABLE	CAL
Time/Div Variable Selector (internal)	Delayed Sweep
DELAY TIME MULT	1.00
TRACE SEP	Midrange

5. Set the oscilloscope to display the plug-in units and adjust for a well-defined display. See oscilloscope and amplifier plug-in unit instruction manuals for detailed operating instructions.

Sweep Functions

Normal Sweep. Perform the following procedure to obtain a normal sweep and demonstrate the function of the related sweep controls:

1. Perform the Setup Procedure.
2. Connect a 4 volt, one-kilohertz signal from the oscilloscope calibrator to the amplifier plug-in unit input.
3. Adjust the amplifier plug-in unit volts/division switch for two divisions of display.
4. Rotate the MAIN TRIGGERING LEVEL control for a stable display.
5. Rotate the POSITION control and note that the trace moves horizontally.
6. Check the crt display for one complete cycle per division. If necessary, adjust the SWP CAL screwdriver adjustment for one complete cycle per division over the center eight graticule divisions. Be sure that the timing of the calibrator signal is accurate within 0.5%.

Alternate and Delayed Sweep. Perform the following procedure to obtain alternate-delayed sweeps and demonstrate the function of the related sweep controls:

7. Pull out the DLY'D Time/Division knob and rotate clockwise to 0.1 ms for the Alternate sweep mode. Note both an intensified trace and a normal-intensity delayed sweep trace on the crt. Increased oscilloscope intensity may be required for viewing the delayed sweep.
8. Rotate the INTENSITY control and note that it varies the intensity of the delaying sweep.
9. Rotate the CONTRAST adjustment for adequate identification on the intensified portion of the delaying sweep when alternating with Delayed sweep.

NOTE

When operating in the Intensified mode, the intensified zone is controlled by the intensity of the test oscilloscope instead of the 7B92A CONTRAST and INTENSITY controls.

10. Rotate the TRACE SEP control to vertically position the delaying sweep trace with respect to the delayed sweep trace. With the TRACE SEP control in the ALT OFF position, only the Intensified sweep will be displayed.

11. Rotate the DELAY TIME MULT dial and note that the amount of delay time before the intensified portion of the display is controlled by the DELAY TIME MULT dial.

12. Press the DLY'D Time/Division switch in for the Delayed sweep mode. Note the delayed display with sweep rate determined by the DLY'D Time/Division switch.

13. Press and release the VARIABLE control. Rotate the VARIABLE control and note that the sweep rate indicated by the DLY'D Time/Division switch can be varied to at least the sweep rate of the next adjacent position (0.2 ms). The internal Time/Div Variable Selector must be set to the Delayed Sweep position. Return the VARIABLE control to the CAL position (knob in).

Triggering Functions

Main and Delayed Triggering. Perform the following procedure to obtain a triggered alternate, normal, or delayed sweep and demonstrate the function of the related controls:

14. Perform the Setup Procedure. Connect the one-kilohertz calibrator signal from the oscilloscope to the amplifier plug-in unit input and adjust for about four divisions of vertical display.

15. Set the DLY'D Time/Division switch and the TIME/DIV OR DLY TIME switch to 1 ms, and press in the DLY'D Time/Division knob (normal sweep mode). Rotate the MAIN TRIGGERING LEVEL control for a stable display.

16. Check that a stable display can be obtained with the MAIN TRIGGERING COUPLING switch set to AC, AC HF REJ, and DC, for both the positive and negative positions of the SLOPE control (MAIN TRIGGERING LEVEL control may be adjusted as necessary to obtain a stable display). Remove all connections from the oscilloscope system.

17. Connect a 0.4 volt, one-kilohertz signal from the oscilloscope calibrator to the amplifier plug-in unit and to the MAIN TRIG IN connector. Set the MAIN TRIGGERING SOURCE switch to EXT. Set the amplifier plug-in unit volts/div switch for about four divisions of display. Check that a stable display can be obtained with the MAIN TRIGGERING COUPLING switch set to AC, AC HF REJ,

and DC, for both the positive and negative positions of the SLOPE control (MAIN TRIGGERING LEVEL control may be adjusted as necessary for a stable display).

18. Change the MAIN TRIGGERING SOURCE switch to EXT \div 10. Set the oscilloscope calibrator for four volts at one kilohertz and adjust the amplifier plug-in unit volts/div switch for about four divisions of display. Check that a stable display can be obtained with the MAIN TRIGGERING COUPLING switch set to AC, AC HF REJ, and DC, for both the positive and negative positions of the SLOPE control (MAIN TRIGGERING LEVEL control may be adjusted as necessary to obtain a stable display). Remove all connections from the oscilloscope system.

19. Set the MAIN TRIGGERING COUPLING switch to AC and SOURCE switch to INT. Connect a one-kilohertz calibrator signal from the oscilloscope to the amplifier plug-in unit input and adjust for about four divisions of display amplitude. Adjust the MAIN TRIGGERING LEVEL control for a stable display. Set the MODE switch to NORM and check for a stable display. Change the MODE switch to AUTO and adjust the LEVEL control for a free-running display. Change the MODE switch to NORM and check for no display.

20. Adjust the MAIN TRIGGERING LEVEL control for a stable display. Change the MAIN TRIGGERING MODE switch to SINGLE SWEEP. Press the RESET button and check for one sweep as the RESET button is pressed. Remove the one-kilohertz signal from the amplifier plug-in unit and press the RESET button. Check for no display and RESET button light on. Connect the one-kilohertz signal to the amplifier plug-in unit input and check for one sweep as the signal is applied. Remove all connections from the oscilloscope system.

21. Set the MAIN TRIGGERING MODE switch to AUTO and SOURCE switch to AC. Turn the Delayed Triggering LEVEL control fully clockwise to the RUNS AFTER DELAY TIME position. Pull out the DLY'D Time/Division switch and rotate to 0.2 ms (Alternate mode). Connect a 0.4 volt, one-kilohertz signal from the oscilloscope calibrator to the amplifier plug-in unit input and adjust for about two divisions of display amplitude. Rotate the MAIN TRIGGERING LEVEL control for a stable intensified display. The INTENSITY control may need to be adjusted to view the intensified display. Rotate the DELAY TIME MULT dial and note that the delay time before the intensified portion of display is continuously variable.

22. Set the Delayed Triggering SLOPE, COUPLING, and SOURCE switches to (+), AC, and INT. Rotate the Delayed Triggering LEVEL control counterclockwise out of the detent and adjust for a stable display. Rotate the

Operating Instructions—7B92A

DELAY TIME MULT dial and note that the intensified sweep does not start at the completion of the delay time but waits for the next trigger pulse.

23. Check that a stable display can be obtained with the Delayed Triggering COUPLING switch set to AC and DC for both the (+) and (−) positions of the SLOPE switch (Delayed Triggering LEVEL control may be adjusted as necessary for a stable display).

24. Change the Delayed Triggering SOURCE switch to EXT. Connect a 0.4 volt, one-kilohertz signal from the oscilloscope calibrator to the DLY'D TRIG IN connector. Check that a stable display can be obtained with the Delayed Triggering COUPLING switch set to AC and DC, for both the (+) and (−) positions of the SLOPE switch (Delayed Triggering LEVEL control may be adjusted as necessary for a stable delayed sweep display).

High-Frequency Synchronization. Perform the following procedure to obtain a triggered alternate, normal, or delayed sweep with a 100 megahertz to 500 megahertz input signal:

NOTE

To check HF sync operation, a signal source frequency between 100 megahertz and 500 megahertz is required. If a 100 to 500 megahertz signal source is not available, or if it is not desired to check the HF sync operation, the last two steps of this procedure may be deleted.

25. Change the MAIN TRIGGERING MODE switch to HF SYNC. Connect a high-frequency signal source (100 to 500 megahertz) to the amplifier plug-in unit input and adjust for four divisions of vertical deflection. Adjust the TIME/DIV OR DLY TIME switch and DLY'D Time/Division switch for about six cycles of display. Rotate the MAIN TRIGGERING LEVEL control throughout its range and note that the sweep is alternately stable, then free-running, several times during the rotation (stable display indicates that the trigger-generator frequency is adjusted to a sub-harmonic of the trigger signal frequency). Check that stable displays can also be obtained with the MAIN TRIGGERING COUPLING switch set to AC, AC LF REJ, and DC (MAIN TRIGGERING LEVEL control may be adjusted, as necessary, for a stable display).

26. Pull out the DLY'D Time/Division switch and rotate it to the next fastest sweep rate from the setting of the TIME/DIV OR DLY TIME switch (Alternate mode). When the LEVEL control is in the detent (RUNS AFTER DELAY TIME) the display should be stable. Rotate the LEVEL control counterclockwise out of the detent and adjust for a

stable display. Check that stable crt displays can be obtained with the Delayed Triggering COUPLING switch set to AC and DC. Disconnect the high-frequency signal from the oscilloscope system.

GENERAL OPERATING INFORMATION

MAIN TRIGGERING

The MAIN TRIGGERING MODE, COUPLING, and SOURCE pushbutton switches are arranged in a sequence which places the most-often used position at the top of each series of pushbuttons. With this arrangement, a stable display can usually be obtained by pressing the top pushbuttons: AUTO, AC, and INT. When an adequate trigger signal is applied and the LEVEL control is set correctly, the TRIG'D indicator will light. If the TRIG'D indicator is not lit: (1) the LEVEL control is at a setting outside the range of the trigger signal from the amplifier plug-in unit, (2) the trigger signal is inadequate, or (3) the trigger-signal frequency is below the lower frequency limit of the COUPLING switch position. If the desired display is not obtained with these pushbuttons, other selections must be made. Refer to the following discussions or the instruction manuals for the oscilloscope and amplifier plug-in unit for more information.

Main Trigger Modes

The MODE pushbutton switch selects the mode in which the main sweep is triggered.

AUTO. The AUTO pushbutton provides a triggered display with the correct setting of the LEVEL control (see Trigger Level discussion) whenever an adequate trigger signal is applied. The TRIG'D indicator lights when the display is triggered.

When the trigger repetition rate is outside the frequency range selected by the COUPLING switch or the trigger signal is inadequate, the sweep free-runs at the sweep rate indicated by the TIME/DIV OR DLY TIME switch (TRIG'D indicator off). An adequate trigger signal ends the free-running condition and a triggered display is presented. When the LEVEL control is at a setting outside the amplitude range of the trigger signal, the sweep also free runs at the sweep rate indicated by the TIME/DIV OR DLY TIME switch. This type of free-running display can be useful when it is desired to measure only the maximum peak-to-peak amplitude of a signal without observing the waveshape (such as in bandwidth measurements).

HF SYNC. The HF SYNC pushbutton permits stable displays of repetitive signals with only 0.5 division of internal trigger signal (100 millivolts external signal) required for frequencies between 100 megahertz and 500 megahertz.

A triggered display is obtained when the LEVEL control adjusts the frequency of the trigger generator to the frequency or sub-harmonic of the trigger signal. Stable displays may be obtained several times between the limits of the LEVEL control, depending on the amplitude and frequency of the trigger signal. The LEVEL control should be set for optimum display. (In the High-Frequency Synchronization mode, the display is not necessarily stable when the TRIG'D indicator is lit.)

When the LEVEL control is adjusted between sub-harmonics of the trigger signal frequency, the trigger repetition rate is below 100 megahertz or outside the frequency range selected by the COUPLING switch, or the trigger signal amplitude is inadequate, the sweep free-runs at the sweep rate determined by the TIME/DIV OR DLY TIME switch.

NORM. The NORM pushbutton provides a triggered display with the correct setting of the LEVEL control whenever an adequate trigger signal is applied. The TRIG'D indicator lights when the display is triggered.

The NORM trigger mode must be used to produce triggered displays with trigger repetition rates below about 30 hertz. When the TRIG'D indicator is off, no trace will be displayed.

SINGLE SWEEP. When the signal to be displayed is not repetitive or varies in amplitude, waveshape, or repetition rate, a conventional repetitive type display may produce an unstable presentation. A stable display can often be obtained under these circumstances by using the single-sweep feature of this unit. The Single Sweep mode is also useful to photograph non-repetitive or unstable displays.

To obtain a single-sweep display of a repetitive signal, first obtain the best possible display in the Norm mode. Then, without changing the other MAIN TRIGGERING controls, press the SINGLE SWEEP-RESET pushbutton. A single trace is presented each time the pushbutton is pressed. Further sweeps cannot be presented until the SINGLE SWEEP-RESET pushbutton is pressed again. If the displayed signal is a complex waveform composed of pulses of varying amplitude, successive single-sweep displays may not start at the same point on the waveform. To avoid confusion due to the crt persistence, allow the display to disappear before pressing the SINGLE SWEEP-RESET pushbutton again. At fast sweep rates, it may be difficult to view the single-sweep display. The apparent trace intensity can be increased by reducing the ambient light level or using a viewing hood as recommended in the oscilloscope instruction manual.

When using the Single Sweep mode to photograph waveforms, the graticule must be photographed separately in the normal manner to prevent over-exposing the film. Be sure the camera system is well protected against stray light, or operate the system in a darkened room. For repetitive waveforms, press the SINGLE SWEEP-RESET pushbutton only once for each waveform unless the signal is completely symmetrical. Otherwise, multiple waveforms may appear on the film. For random signals, the lens can be left open until the signal triggers the unit. Further information on photographic techniques is given in the appropriate camera instruction manual.

Main Trigger Coupling

The MAIN TRIGGERING COUPLING switches select the method in which the trigger signal is connected to the trigger circuits. Each position permits selection or rejection of some frequency components of the trigger signal which trigger the sweep.

AC. The AC pushbutton blocks the dc component of the trigger signal. Signals with low-frequency components below about 30 hertz are attenuated. In general, ac coupling can be used for most applications. However, if the signal contains unwanted frequency components, or if the sweep is to be triggered at a low repetition rate or dc level, one of the other COUPLING switch positions will provide a better display.

AC LF REJ. The AC LF REJ pushbutton rejects dc, and attenuates low-frequency trigger signals below about 30 kilohertz. Therefore, the sweep is triggered only by the higher-frequency components of the trigger signal. This position is particularly useful for providing stable triggering if the trigger signal contains line-frequency components. Also, the AC LF REJ position provides the best Alternate mode vertical displays at fast sweep rates when comparing two or more unrelated signals.

AC HF REJ. The AC HF REJ pushbutton passes all low-frequency signals between about 30 hertz and 50 kilohertz. The dc component is rejected and signals outside the above range are attenuated. When triggering from complex waveforms, this position is useful to provide a stable display of the low-frequency components. AC HF REJ coupling should not be used when operating in the HF SYNC triggering mode.

DC. The DC pushbutton can be used to provide stable triggering from low-frequency signals which would be attenuated in the other modes. It can also be used to trigger the sweep when the trigger signal reaches a dc level set by the LEVEL control. When using internal triggering, the setting of the amplifier plug-in unit position control affects the triggering point.

Main Trigger Source

The MAIN TRIGGERING SOURCE pushbutton switches select the source of the trigger signal that is connected to the main trigger circuits.

INT. The INT pushbutton connects the trigger signal from the amplifier plug-in unit. Further selection of the internal trigger signal may be provided by the amplifier plug-in unit or oscilloscope; see the instruction manuals for these instruments for more information. For most applications, the internal source can be used. However, some applications require special triggering that cannot be obtained in the INT position. In such cases, the LINE or EXT positions of the SOURCE switches must be used.

LINE. The LINE pushbutton connects a sample of the power-line voltage from the oscilloscope to the trigger circuit. Line triggering is useful when the input signal is time-related (multiple or submultiple) to the line frequency. It is also useful for providing a stable display of a line-frequency component in a complex waveform. Line triggering cannot be used when operating in the HF sync triggering mode.

EXT. The EXT pushbutton connects the signal from the MAIN TRIG IN connector to the trigger circuit. The external signal must be time-related to the displayed waveform for a stable display. An external trigger signal can be used to provide a triggered display when the internal signal is too low in amplitude for correct triggering, or contains signal components on which triggering is not desired. It is also useful when signal tracing in amplifiers, phase-shift networks, wave-shaping circuits, etc. The signal from a single point in the circuit can be connected to the MAIN TRIG IN connector through a probe or cable. The sweep is then triggered by the same signal at all times and allows amplitude, time relationship, or waveshape changes of signals at various points in the circuit to be examined without resetting the MAIN TRIGGERING controls.

EXT ÷ 10. The EXT ÷ 10 pushbutton operates the same as described for EXT except that the external signal is attenuated. Attenuation of high-amplitude external trigger signals is desirable to increase the effective range of the LEVEL control.

Input Impedance

The input impedance of the MAIN TRIG IN and DLY'D TRIG IN connectors may be selected by the front-panel TERM switch.

FRONT-PANEL IN — 1 MΩ. The 1 MΩ position is suitable for most low- and medium-frequency applications or when using a 10X probe. The 1 MΩ position provides a high input impedance for minimum loading on the trigger signal source.

FRONT-PANEL OUT — 50 Ω. The 50 Ω position is recommended for high-frequency applications requiring maximum overall bandwidth. The 50 ohm termination should be used when externally triggering from a 50 ohm system.

Trigger Slope

The MAIN TRIGGERING SLOPE control (concentric with the MAIN TRIGGERING LEVEL control) determines whether the trigger circuit responds on the positive-going or negative-going portion of the trigger signal. The trigger slope cannot be selected when operating in the high-frequency synchronization mode. When the SLOPE control is in the + (positive-going) position, the display starts on the positive-going portion of the waveform; in the -- (negative-going) position, the display starts on the negative-going portion of the waveform (see Fig. 1-4). When several cycles of a signal appear in the display, the setting of the SLOPE control is often unimportant. However, if only a certain portion of a cycle is to be displayed, correct setting of the SLOPE control is important to provide a display which starts on the desired slope of the input signal.

Trigger Level

The MAIN TRIGGERING LEVEL control determines the voltage level on the trigger signal at which the sweep is triggered when operating in the Auto, Norm, or Single Sweep modes. When the LEVEL control is set in the + region, the trigger circuit responds at a more positive point on the trigger signal. When the LEVEL control is set in the -- region, the trigger circuit responds at a more negative point on the trigger signal. Fig. 1-4 illustrates this effect with different settings of the SLOPE switch.

To set the LEVEL control, first select the MAIN TRIGGERING MODE, COUPLING, SOURCE, and SLOPE. Then set the LEVEL control fully counterclockwise and rotate it clockwise until the display starts at the desired point. Less selection of the triggering level is available as the trigger signal frequency exceeds 150 megahertz.

When operating in the MAIN TRIGGERING HF sync mode, the LEVEL control synchronizes the trigger generator frequency to a sub-harmonic of the trigger signal frequency. Trigger slope and level cannot be selected.

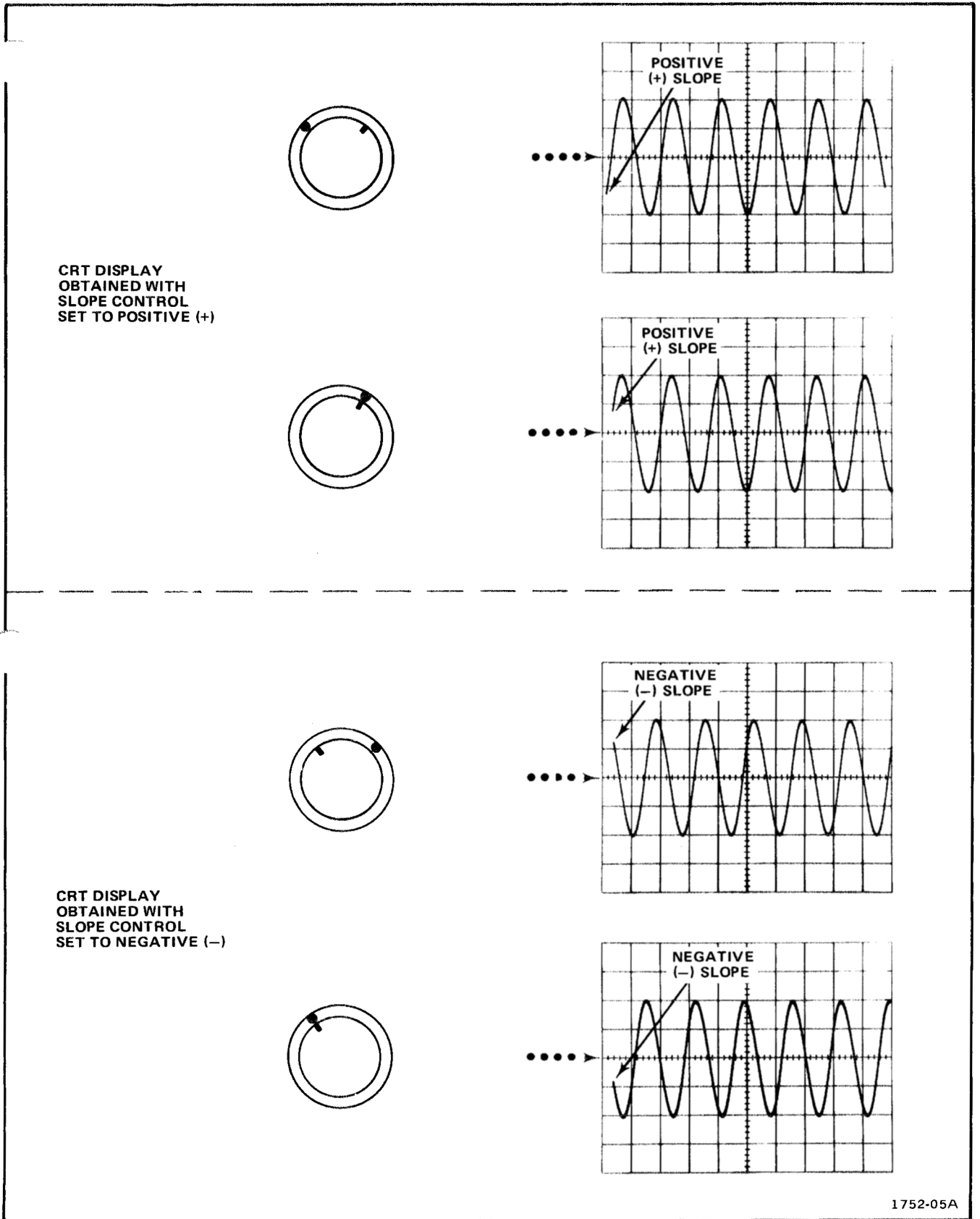

1752-05A

Fig. 1-4. Effect of MAIN TRIGGERING LEVEL and SLOPE controls on crt display.

Selecting Sweep Rates

The TIME/DIV OR DLY TIME switch selects calibrated sweep rates for the delaying sweep. The DLY'D Time/Division switch selects calibrated sweep rates for the delayed sweep. The sweep rate for the delaying sweep is bracketed by the black lines on the clear plastic flange of the TIME/DIV OR DLY TIME switch. Sweep rate of the delayed sweep is indicated by the white line on the DLY'D Time/Division knob. When the white line on the outer knob is set to the same position as the lines on the inner knob, the two knobs lock together and the sweep rate of both generators is changed at the same time. However, when the DLY'D Time/Division knob is pulled outward, the clear plastic flange is disengaged and only the delayed sweep rate is changed. This allows changing the delayed sweep rate without changing the delaying sweep rate. The TIME/DIV OR DLY TIME switch and the DLY'D Time/Division switch also select display modes. See Display Mode discussion in this section for further information.

A VARIABLE control is provided concentric with the TIME/DIV OR DLY TIME and DLY'D Time/Division switches (see Fig. 1-3). This control can be used with either the delaying or delayed sweeps as determined by the Time/Div Variable Selector multi-pin connector (internal, see Fig. 1-1 for location). The VARIABLE control also incorporates a two-position switch to determine if the applicable sweep is calibrated or uncalibrated. When the VARIABLE control is pressed in, it is inoperative. However, when pressed and released, the VARIABLE control is activated for uncalibrated sweep rates. The sweep rate can be returned to the calibrated position by pressing the VARIABLE knob in. This feature is useful when a specific uncalibrated sweep rate has been obtained and it is desired to switch between calibrated and uncalibrated sweep rates. Switching from uncalibrated to calibrated and vice-versa does not affect the setting of the VARIABLE control. The VARIABLE control allows the sweep rate in each Time/Division switch position to be increased to at least the next adjacent switch position.

Time Measurement

When making time measurements from the graticule, the area between the second and tenth vertical lines of the graticule provides the most linear time measurements (see Fig. 1-5). Position the start of the timing area to the second vertical line and adjust the TIME/DIV OR DLY TIME switch so the end of the timing area falls between the fourth and tenth vertical lines.

Display Modes

Four display modes can be selected by appropriate settings of the TIME/DIV OR DLY TIME and DLY'D Time/Division switches.

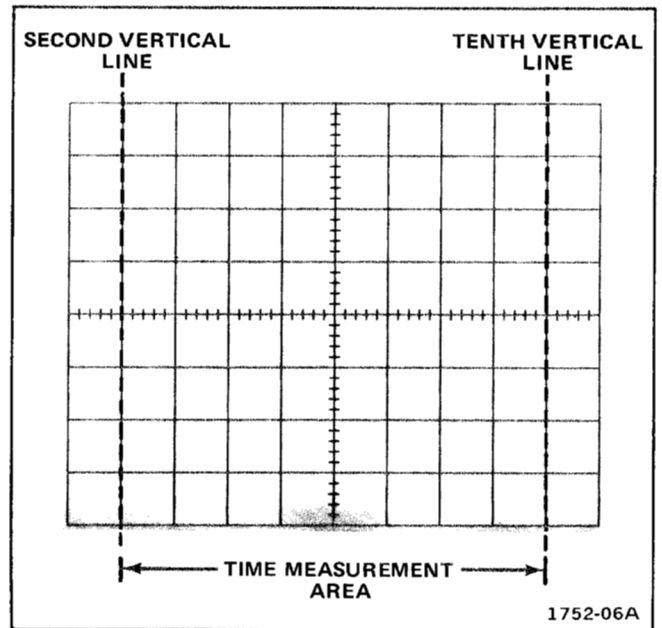

Fig. 1-5. Area of graticule used for most accurate time measurements.

Normal Sweep Operation. To select the Normal sweep display mode, press in the DLY'D Time/Division switch and set it to the same sweep rate as the TIME/DIV OR DLY TIME switch. Rotate the Delayed Triggering LEVEL control clockwise into the detent to the RUNS AFTER DELAY TIME position.

Calibrated sweep rates in the Normal sweep display mode are 0.2 s/Div to 0.5 ns/Div. By using the VARIABLE control (Time/Div Variable Selector connector set for variable Delayed Sweep rates) uncalibrated sweep rates to 0.5 s/Div are available. Triggering in the Normal sweep display mode is controlled by the MAIN TRIGGERING controls.

Alternate Sweep Display. To select the Alternate display mode, pull out the DLY'D Time/Division knob and rotate it to a desired sweep rate faster than the TIME/DIV OR DLY TIME switch setting. In this mode, both an intensified sweep and a delayed sweep are displayed (see Fig. 1-6).

The intensified trace of the Alternate sweep display provides an intensified portion on the delaying sweep during the time the delayed sweep is running. The amount of delay time between the start of the delaying sweep and the intensified portion is determined by the TIME/DIV OR DLY TIME switch and the DELAY TIME MULT dial. Triggering for the delaying sweep portion of the intensified trace is controlled by the MAIN TRIGGERING controls; triggering for the intensified portion of the delayed sweep trace is controlled by the Delayed Triggering controls.

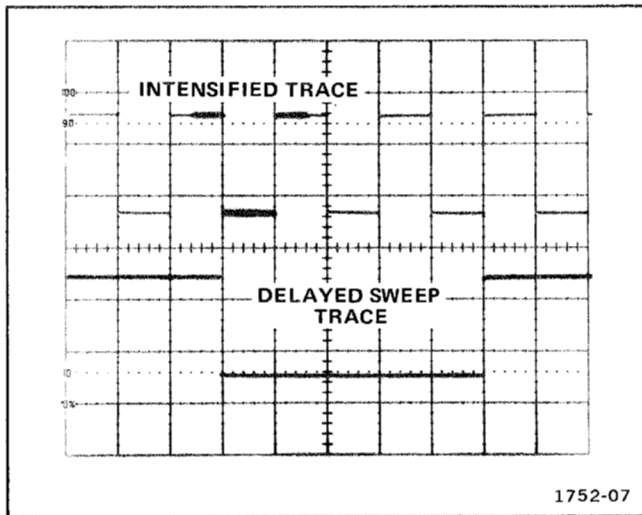

Fig. 1-6. Typical alternate sweep display.

The TRACE SEP control vertically positions the intensified trace up to 3.5 divisions above the delayed sweep trace. The brightness of the intensified zone may be varied by the CONTRAST adjustment. The brightness of the intensified sweep may be varied by the 7B92A INTENSITY control.

Intensified Sweep Mode. The Intensified sweep mode is selected when the DLY'D Time/Division switch is pulled out, rotated to the desired sweep rate faster than the TIME/DIV OR DLY TIME switch setting, and the TRACE SEP control is rotated counterclockwise to the ALT OFF position.

Delayed Sweep Display. The Delayed sweep display mode is selected when the DLY'D Time/Division switch is pulled out, rotated to the desired sweep rate, and then pushed in. In this mode, only the delayed sweep is displayed.

Calibrated sweep rates in the Delayed sweep mode are available from 0.2 s/Div to 0.5 ns/Div. By using the VARIABLE control (Time/Div Variable Selector connector set for variable delayed sweep rates), uncalibrated delayed sweep rates to 0.5 s/Div are available. Triggering for the delayed sweep is controlled by the Delayed Triggering controls.

Delay Time Multiplier

The DELAY TIME MULT dial (functional in the Delayed, Intensified, Alternate, or Mainframe Delaying modes) provides 0 to 9.8 times continuous sweep delay. The amount of time that the delaying sweep runs before the start of the delayed sweep is determined by the settings of the TIME/DIV OR DLY TIME switch and the DELAY TIME MULT dial.

For example, a DELAY TIME MULT dial setting of 3.55 corresponds to 3.55 crt divisions of delaying sweep. Thus, 3.55 multiplied by the delaying sweep rate, indicated by the TIME/DIV OR DLY TIME switch, gives the calibrated delay time before the start of the delayed sweep.

Delayed Sweep Triggering

The Delayed Triggering LEVEL control determines the delayed triggering mode, and delayed triggering level. When the LEVEL control is in the RUNS AFTER DLY TIME detent position (fully clockwise), the delayed sweep starts immediately after the delay time (determined by the TIME/DIV OR DLY TIME switch and DELAY TIME MULT dial). This mode permits selection of continuously variable delay times by rotating the DELAY TIME MULT dial. The Delayed Triggering LEVEL control and SLOPE, COUPLING, and SOURCE switches are inoperative.

When the delayed sweep is triggerable (Delayed Triggering LEVEL out of the RUNS AFTER DELAY detent), the delayed sweep does not start at the completion of the delay time. Instead, it waits until a trigger pulse is received by the Delayed Triggering circuits. The delay time in this mode is dependent not only on the settings of the delay time controls, but on the Delayed Triggering controls and the occurrence of the delayed-sweep triggering signal as well. The primary purpose of this mode is to eliminate jitter from the delayed sweep is triggered by the input waveform, jitter is eliminated from the delayed sweep display even though it may be inherent in the input waveform. When jitter in the delayed sweep display is not a problem, the Runs After Dly Time mode should be used.

In the Delayed Sweep Triggerable mode, the Delayed Triggering LEVEL control is rotated to select the amplitude point on the trigger signal at which the delayed sweep is triggered. The Slope, Coupling, and Source functions are the same for delayed triggering as for MAIN TRIGGERING (see MAIN TRIGGERING SLOPE, COUPLING, SOURCE, and TERM switch discussions in this section).

SPECIFICATION

This instrument will meet the electrical characteristics listed under Performance Requirement in Table 2-1, following complete calibration. The following electrical characteristics apply over an ambient temperature range of 0°C to +50°C, except as otherwise indicated. Warm-up time for given accuracy is 20 minutes.

Table 2-1

ELECTRICAL CHARACTERISTICS

Characteristic	Performance Requirement		Supplemental Information
MAIN TRIGGERING			
Trigger Sensitivity	Triggering Frequency Range	Minimum Triggering Signal Required	
Operating in AUTO, NORM, or SINGLE SWEEP MODE		INT ² (div)	EXT ³ (mV)
COUPLING			
AC	30 Hz to 20 MHz 20 MHz to 500 MHz	0.5 1.0	100 500
AC LF REJ ¹	30 kHz to 20 MHz 20 MHz to 500 MHz	0.5 1.0	100 500
AC HF REJ	30 Hz to 50 kHz	0.5	100
DC	Dc to 20 MHz 20 MHz to 500 MHz	0.5 1.0	100 500
Operating in HF SYNC MODE			
AC AC LF REJ DC	100 MHz to 500 MHz	0.5	100
AC HF REJ	Not recommended for HF SYNC MODE		Use NORM or SINGLE SWEEP MODE for signals below about 30 Hz
External Trigger Input			
Level Range			
EXT	At least + and -3.5 volts		Not applicable in HF SYNC MAIN TRIGGERING MODE
EXT ÷ 10	At least + and -35 volts		
Maximum Safe Input			
1 MΩ Input			250 V (dc + peak ac)
50 Ω Input			1 W average (7 V rms)
Input R and C			
1 MΩ Input			Approximately 1 MΩ paralleled by approximately 20 pF

Table 2-1 (cont)

Characteristic	Performance Requirement			Supplemental Information
50 Ω Input				
Resistance				50 Ω within 7%
Reflection Coefficient (Time Domain)				0.1 p-p (using 1 GHz Reflectometer)
Trigger Jitter				
Internal or External	50 ps or less at 500 MHz			
Delayed Triggering				
Trigger Sensitivity	Triggering Frequency Range	Minimum Triggering Signal Required		
		INT ⁴ (div)	EXT (mV)	
COUPLING				
AC	30 Hz to 20 MHz	0.5	100	
	20 MHz to 500 MHz	1.0	500	
DC	Dc to 20 MHz	0.5	100	
	20 MHz to 500 MHz	1.0	500	
Trigger Jitter				
Internal or External	50 ps or less at 500 MHz			
External Trigger Input				
Level Range				
EXT	At least +3.5 V to -3.5 V			
Maximum Safe Input				
1 MΩ Input				250 V (dc + peak ac)
50 Ω Input				1 W average (7 V rms)
Input R and C				
1 MΩ Input				Approximately 1 MΩ paralleled by approximately 20 pF
50 Ω Input				
Resistance				50 Ω within 7%
Reflection Coefficient (Time Domain)				0.1 p-p (using 1 GHz Reflectometer)
Normal, Alternate (Delayed Sweep Trace) and Delayed Sweep				
Sweep Rates	0.2 s/div to 0.5 ns/div in 27 calibrated steps			Selected by TIME/DIV OR DELAY TIME switch. Steps in a 1-2-5 sequence

Table 2-1 (cont)

Characteristic	Performance Requirement		Supplemental Information
Sweep Accuracy	Measured in 7900-Series Oscilloscope		
Over Center 8 Div	+15°C to +35°C	0°C to +50°C	
.2 s/Div to 20 ns/Div	Within 2%	Within 3%	
10 ns/Div to 5 ns/Div	Within 3%	Within 4%	
2 ns/Div to 1 ns/Div	Within 4%	Within 5%	
.5 ns/Div	Within 5%	Within 6%	
Over Any 2 Div Portion Within Center 8 Div			
.2 s/Div to 10 ns/Div	Within 5%	Within 5%	
5 ns/Div to .5 ns/Div	Within 10%	Within 10%	
Variable Sweep Rate	Continuously variable between calibrated sweep rates		Extends sweep rate to at least 0.5 s. VARIABLE control internally switchable between Delaying and Delayed Sweeps. Variable range at least 2.5:1
Intensified Sweep (Delaying Sweep Trace of Alternate Display) Sweep Rates	0.2 s/div to 10 ns/div in 23 calibrated steps		Selected by TIME/DIV OR DLY TIME switch. Steps in a 1-2-5 sequence
Sweep Accuracy	Measured in 7900-Series Oscilloscope		
Over Center 8 Div	+15°C to +35°C	0°C to +50°C	
.2 s/Div to 20 ns/Div	Within 2%	Within 3%	
10 ns/Div	Within 3%	Within 4%	
Over Any 2 Div Portion Within 8 Div	Within 5%	Within 5%	
Variable Sweep Rate	Continuously variable between calibrated sweep rates		Extends sweep rate to at least 0.5 s. Variable control internally switchable between Delaying and Delayed Sweeps
Trace Separation	Intensified sweep can be positioned at least 3.5 div above the delayed sweep		
ALT OFF	Intensified sweep of the delaying sweep is displayed when the TIME/DIV OR DELAY TIME switch is pulled out and rotated clockwise, and the TRACE SEP control is in ALT OFF position		Allow Intensified mode of operation
Variable Time Delay			
Delay Time Range			
DLY TIME/DIV Settings			
.2 s/Div to 10 ns/Div	0 to 9.8 times the DLY TIME switch setting (0 to 1.96 s)		

Table 2-1 (cont)

Characteristic	Performance Requirement	Supplemental Information
Differential Delay Time Measurement Accuracy +15°C to +35°C .2 s/Div to .1 μs/Div Both DELAY TIME MULT dial settings at 0.50 or greater	Within 0.75% of measurement +0.25% of full scale	Full scale is 10 times the TIME/DIV OR DLY TIME setting
One or both DELAY TIME MULT dial settings less than 0.50	Within 0.75% of measurement +0.5% of full scale +5 ns	
50 ns/Div to 10 ns/Div Both delay times equal to or greater than 25 ns	Within 1.0% of measurement +0.5% of full scale	
One or both delay times less than 25 ns	Within 1.0% of measurement +1.0% of full scale +5 ns	
Delay Time Jitter		Jitter specification does not apply to the first 2% of the maximum available delay time (DELAY TIME MULT dial setting less than 0.20)
0.2 s/Div to 50 μs/Div	1 part or less in 50,000 of the maximum available delay time (10 times the TIME/DIV OR DLY TIME switch setting)	
20 μs/Div to 10 ns/Div	1 part or less in 50,000 of the maximum available delay time (10 times the TIME/DIV OR DLY TIME switch setting +0.5 ns)	

¹ Will not trigger on the sine waves of 8 div amplitude or less (internal), or 3 V or less (external) at 60 Hz or below.

² For Internal Triggering only, the specified -3 dB frequency of the Vertical System replaces any frequencies in the above table when the number in the table is greater than the -3 dB frequency of the Vertical System.

³ Triggering signal amplitude requirements increased by factor of 10 for EXT ÷ 10 operation.

⁴ The specified -3 dB frequency of the Vertical System replaces any frequencies in the above table when the number in the table is greater than the -3 dB frequency of the Vertical System.

Table 2-2

ENVIRONMENTAL

Refer to the Specification for the associated oscilloscope.

Table 2-3

PHYSICAL

Net Weight	3.062 lbs (1.372 kg)
Dimensions	See Fig. 2-1, Dimensional Drawing

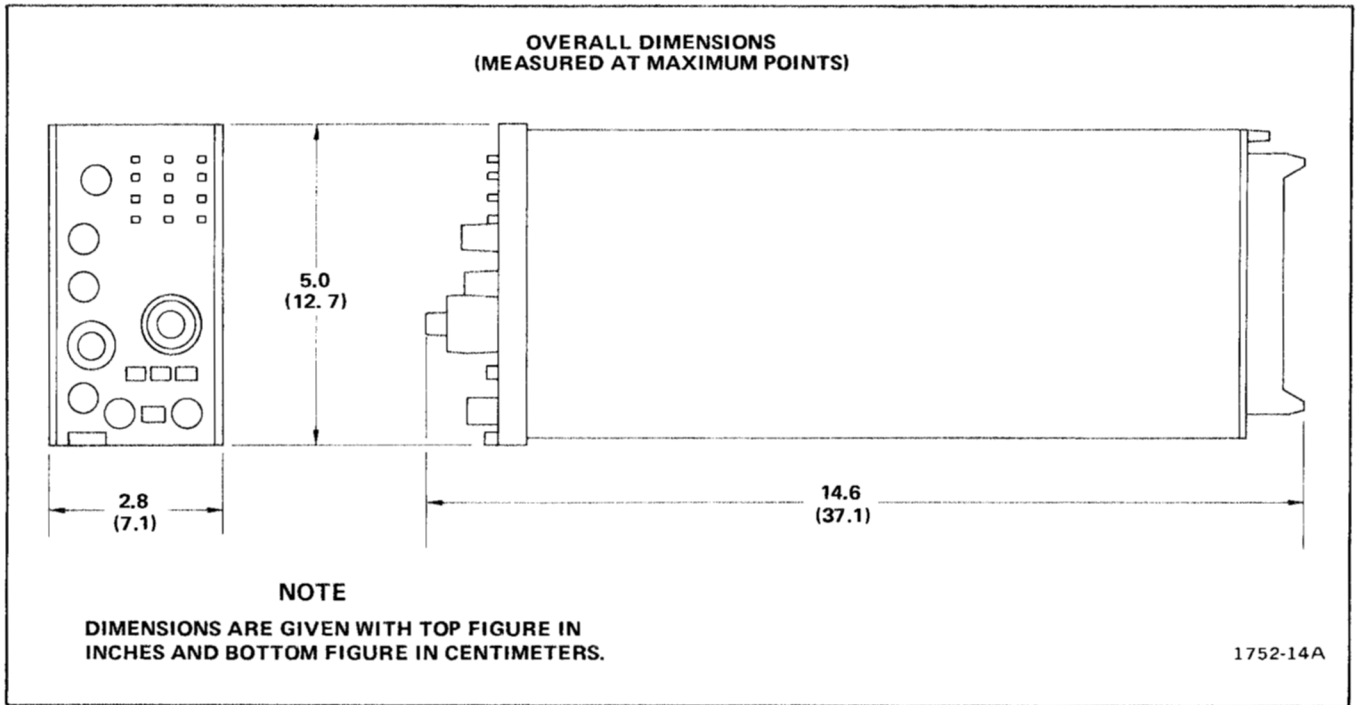

Fig. 2-1. Dimensional drawing.

THEORY OF OPERATION

This section of the manual contains a description of the circuitry used in the 7B92A. The description begins with a discussion of the instrument using the block diagram in the Diagrams section. Each circuit is then described in detail with a block diagram provided to show the major interconnections between circuits, and the relationship of the front-panel controls to each circuit.

BLOCK DIAGRAM DESCRIPTION

The Main Trigger Generator ensures a stable crt display by starting each sweep at the same point on the waveform. The output of the Main Trigger Generator is a fast-rise pulse which starts the Delaying Sweep Generator.

The Delaying Sweep Generator produces a linear voltage ramp. This ramp is displayed when the time base is in the Intensified or Alternate mode. The Delaying Sweep ramp is also used as a delay-time reference when the time base is in the Alternate or Delayed mode. The delay time is set by the slope of the Delaying Sweep ramp and the Delay Pickoff comparator voltage. When the time base is in the Normal Sweep mode, the comparator voltage is set to 0 (zero) and the Delay Pickoff outputs a pulse when the Delaying Sweep ramp starts.

The Delayed Trigger Generator produces a fast-rise pulse to start the Delayed Sweep Generator. When the Delayed Trigger Generator is in the Runs After Delay Time mode, the pulse from the Delay Pickoff produces the Delayed Trigger output pulse. When the Delayed Trigger Generator is in the Triggerable After Delay Time mode, the pulse from the Delay Pickoff enables the Delayed Trigger Generator, which then processes the input signal in the same way as the Main Trigger Generator.

The Delayed Sweep Generator produces a linear voltage ramp that is displayed as either the Normal or Delayed sweep.

The Horizontal Logic controls the Main Trigger Generator, the Delayed Trigger Generator, and the Output Amplifier. The Horizontal Logic produces a Trigger Disable pulse which resets the trigger generators and allows the sweep generators to reset and stabilize before starting another ramp. The Horizontal Logic also controls which sweep ramp is passed through the Output Amplifier to be displayed.

The Output Amplifier horizontally positions the crt display and couples the proper sweep ramp(s) to the oscilloscope.

DETAILED CIRCUIT DESCRIPTION

Main Trigger Generator



The Main Trigger Generator provides a stable display by starting the Delaying Sweep Generator at a selected point on the input waveform. The triggering point can be varied by the LEVEL control and may be on either the positive or negative slope of the waveform. The input signal may be the waveform being displayed (INT), a waveform from an external source (EXT or EXT ÷ 10), or a sample of the power-line voltage (LINE).

The bandwidth of the Main Trigger Generator is set by the COUPLING switches. Dc coupling provides a bandwidth of dc to 500 megahertz. Ac coupling blocks dc and frequencies below about 30 hertz. AC LF REJ (ac coupling, low-frequency rejection) passes frequencies above 30 kilohertz. AC HF REJ (ac coupling, high-frequency rejection) passes frequencies between 30 hertz and 30 kilohertz.

External Source (SN B070000-above). The external trigger signal is connected to the Main Trigger Generator through the MAIN TRIG IN connector, J100. The input impedance at J100 can be set to either 1 megohm or 50 ohms by TERM switch S205.

If the SOURCE switch is set to EXT, relay K6 energizes and applies the trigger signal to C11 and R11. Signals below 30 kilohertz are connected to the gate of Q22A through R14, C12, R12, and R11. Signals between 30 kilohertz and 100 megahertz are connected to the gate of Q22A through R17 and C11. These signals pass through Q22A and Q24 to pin 3 of U74. Signals above 100 megahertz are connected to pin 4 of U74 through C20. (Pins 3 and 4 of U74 are internally connected.)

If the SOURCE switch is set to EXT ÷ 10, relay K6 de-energizes and applies the input signal to C10 and R9. The signal is then divided by 10 before being applied to the gate of Q22A.

Theory of Operation—7B92A

External Source (SN B069999-below). The external trigger signal is connected to the Main Trigger Generator through the MAIN TRIG IN connector, J100. The input impedance at J100 can be set to either 1 megohm or 50 ohms by TERM switch S205.

If the SOURCE switch is set to EXT, relay K6 energizes and applies the trigger signal to C11 and R11. Signals below 30 kilohertz are connected to the gate of Q22A through R14, C12, R12, and R11. Signals between 30 kilohertz and 100 megahertz are connected to the gate of Q22A through R17 and C11. These signals pass through Q22A and Q24 to pin 3 of U64. Signals above 100 megahertz are connected to pin 4 of U64 through C20. (Pins 3 and 4 of U64 are internally connected.)

If the SOURCE switch is set to EXT ÷ 10, relay K6 de-energizes and applies the input signal to C10 and R9. The signal is then divided by 10 before being applied to the gate of Q22A.

Internal Source (SN B070000-above). The internal trigger signal from the vertical channel of the oscilloscope is connected to the Main Trigger Generator through J150. Signals below 30 kilohertz are amplified by U44B and connected, along with the offset from the LEVEL control, to pin 1 of U74 and to the base of Q86. Signals above 30 kilohertz are coupled through C46 to pin 14 of U74. (Pins 13 and 14 of U74 are internally connected.)

Internal Source (SN B069999-below). The internal trigger signal from the vertical channel of the oscilloscope is connected to the Main Trigger Generator through J150. Signals below 30 kilohertz are amplified by U128B and connected, along with the offset from the LEVEL control, to pin 1 of U64 and to the base of Q72. Signals above 30 kilohertz are coupled through C46 to pin 14 of U64. (Pins 13 and 14 of U64 are internally connected.)

Internal-External Amplifier (SN B070000-above). Amplifier U74 is a dual-channel, differential amplifier with a common reference voltage for both channels. The input channel to be amplified is selected by the bias on pins 2 and 15. When R77 is connected to -15 volts, the internal trigger signal (pins 13 and 14) is amplified. When R79 is connected to -15 volts, the external trigger signal (pins 3 and 4) is amplified. The push-pull outputs (pins 8 and 9) are connected to the inputs (pins 5 and 8) of U122.

When AC HF REJ coupling is selected, R77 and R79 are both disconnected from -15 volts, disabling U74. The low-frequency signals (below 30 kilohertz) are then connected to U122 through Q86 (internal signals) or Q82 (external or line signals).

Internal-External Amplifier (SN B069999-below). Amplifier U64 is a dual-channel, differential amplifier with a common reference voltage for both channels. The input channel to be amplified is selected by the bias on pins 2 and 15. When R66 is connected to -15 volts, the internal trigger signal (pins 13 and 14) is amplified. When R67 is connected to -15 volts, the external trigger signal (pins 3 and 4) is amplified. The push-pull outputs (pins 8 and 9) are connected to the inputs (pins 3 and 14) of U84.

When AC HF REJ coupling is selected, R66 and R67 are both disconnected from -15 volts, disabling U64. The low-frequency signals (below 30 kilohertz) are then connected to U84 through Q72 (internal signals) or Q74 (external or line signals).

Slope Selector and Trigger Generator (SN B070000-above). U122 selects the slope of the input waveform on which triggering occurs. If pin 3 is high, the time base will trigger on the negative slope of an internal signal or the positive slope of an external signal. If pin 3 is low, the time base will trigger on the positive slope of an internal signal or the negative slope of an external signal. (The internal signal is inverted by U74 or Q86 before being applied to U122.)

The delay mode control signal into U122, pin 4 is functional only when the unit is operating as a delayed sweep unit in the B horizontal compartment of a main-frame with two horizontal compartments. When the unit is operating in the Independent or Triggerable After Delay Time modes (as determined by the delaying sweep time-base unit in the A horizontal compartment), there is no effect on the Trigger Generator circuits. However, when the unit is operating in the B Starts After Delay Time mode, a HI level at U122, pin 4 causes the trigger IC to generate a gate pulse at pin 15 when the trigger disable input goes low.

Slope Selector Amplifier (SN B069999-below). Amplifier U84 selects the slope of the input waveform on which triggering occurs. If pin 6 is high, the time base will trigger on the positive slope of an internal signal or the negative slope of an external signal. If pin 6 is low, the time base will trigger on the negative slope of an internal signal or the positive slope of an external signal. (The internal signal is inverted by U64 or Q72 before being applied to U84.)

The push-pull outputs (pins 7, 8 and 9, 10) of U84 are connected to the inputs (pins 3 and 13) of U104.

Output Amplifier (SN B069999-below). Amplifier U104 provides a final gain stage before driving the trigger-output tunnel diodes. The push-pull output of U104 (pins 8

and 9) drives the emitter and base of Q112. Transistor Q112 converts the push-pull output of U104 to a single-ended output to drive tunnel diode CR114. As the emitter-base voltage of Q112 increases, the current through CR114 increases. When the current through CR114 reaches 10 milliamperes, it switches to its high level. The fast risetime of CR114 is coupled through C141 to the Arming Tunnel Diode, CR172, which also switches high. The high level at the anode of CR172 increases the current through the Gate Tunnel Diode, CR176. The risetime of CR114 is also coupled through C124 (and a 1 nanosecond delay line) to CR176. The combination of the added current from CR172 and the pulse from CR114 (1 nanosecond later) switches CR176 high. The fast-rise pulse from CR176 is connected to the Sweep Start Comparator of the Delaying Sweep Generator.

Trigger Disable (SN B070000-above). At the end of each sweep, the Logic circuits supply a Trigger Disable pulse to U122, pin 2. A HI level disables the trigger generator to allow enough time for the sweep generator to stabilize before another trigger pulse starts the next sweep.

Trigger Disable (SN B069999-below). At the end of each sweep, the Horizontal Logic produces a Trigger Disable pulse to reset the Arming and Gate Tunnel Diodes to a low level and allow enough time for the sweep generator to reset and stabilize before another trigger pulse starts the next sweep. The Trigger Disable signal is connected to the base of Q151 through interconnecting pin CA. When the Trigger Disable pulse is high, Q148 and Q158 turn on, removing the bias current from CR172 and CR176, respectively. The rest of the trigger generator operates normally, but CR172 and CR176 will not switch to a high level.

High-Frequency Synchronization (SN B070000-above). The HF sync mode increases the sensitivity of the trigger generator and is useful at frequencies above 10 megahertz. In the HF sync mode, the trigger generator (U122) is caused to free run by reducing the hysteresis to zero (pin 9). The LEVEL control, R50, adjusts the hysteresis around zero, varying the oscillating frequency and enabling U122 to synchronize with the input signal or a sub-harmonic of the input signal.

The inputs to U122 pins 5 and 8 are forced to be balanced by negative feedback loop U132B, U44A, and U74. This enables the HF sync circuit to function regardless of the dc level of the input signal. U44 is used to select phase of feedback required for the input channel selected.

High-Frequency Synchronization (SN B069999-below). The HF sync mode increases the sensitivity of the trigger generator at frequencies above 100 megahertz. In the HF sync mode, the trigger generator free runs at a frequency determined by the LEVEL control, R50. The LEVEL control adjusts the free-running frequency of the trigger generator to be close enough to the signal frequency, or sub-harmonic, to synchronize with it.

The positive feedback loop required to maintain oscillation is through Q104 to input pin 4 of U104, through Q112 to CR114, and back to Q104. A negative feedback loop is also present to maintain synchronization of the oscillator with the trigger signal. The negative feedback loop is through U128A to input pin 1 of U64, through U84, U104, and Q112 to CR114, and back to U128A.

Delaying Sweep Generator



The Delaying Sweep Generator produces a linear ramp waveform when gated by the Main Trigger Generator. The Delaying Sweep ramp is displayed as the intensified sweep of the Alternate display. The Delaying Sweep ramp is also the time reference for the Delay Pickoff comparator.

The linear ramp waveform is produced by charging a capacitor from a constant current source. The slope of the ramp determines the time/division of the displayed trace and the delay time set by the DELAY TIME MULT dial.

Ramp Generator. When a trigger pulse is received from the Main Trigger Generator, Q402 cuts off and Q404 conducts, driving the base of Q410 high. When Q410 turns on, Q412 turns off and the timing current from Q436 starts to charge the timing capacitors in a positive ramp. The timing current is determined by the timing resistors in the emitter circuit of Q436 and the reference voltage at the base of Q436. The reference is set by the SWP CAL adjustment, R750. Integrated circuit U752 is a unity-gain voltage follower. Diode CR753 compensates for the base-emitter voltage drop of Q436, Q494, and Q536. Transistors Q446A and B and Q450 form a unity-gain voltage-follower for the delaying sweep signal. The output of Q450 is attenuated by divider R468, R469, and R458 before it is connected to the Output Amplifier. The output of Q450 also drives the Sweep Stop Comparator, the Baseline Stabilizer, and the Delay Pickoff.

Sweep Stop Comparator. Transistors Q462 and Q464 control the sweep length. When the Delaying Sweep ramp exceeds the voltage on the base of Q464, Q462 turns off and Q464 provides a positive pulse to end the Auxiliary Gate and produce the Holdoff Start pulse.

Auxiliary Gate Generator. When the trigger pulse cuts off Q402, the negative pulse at the base of Q472 causes the Auxiliary Gate at the emitter of Q474 to go high. The Auxiliary Gate signal remains high until a positive pulse from the Sweep Stop Comparator turns Q468 on, ending the Auxiliary Gate. The positive pulse from the Sweep Stop Comparator is also coupled through CR811 to the base of Q812 and results in a positive Holdoff Start pulse at the collector of Q816. The Holdoff Start pulse is connected to the Horizontal Logic which starts the Trigger Disable pulse.

Baseline Stabilizer. When the Trigger Disable pulse resets the output of the Main Trigger Generator to a low level, Q402 turns on and Q404 turns off. The low level on the base of Q410 turns on Q412, which discharges the timing capacitors. With the timing capacitors discharged, the Baseline Stabilizer maintains a constant level from which the ramp begins. The output of Q450 is compared with the reference on the base of Q420A. If the output is less than the reference, Q430 charges the timing capacitors through CR434 until the output and reference voltages are equal. If the output is greater than the reference, Q430 conducts less and the timing capacitors discharge through Q412. When the two voltages are equal, the currents through Q430 and Q436 equal the current through Q412, holding the voltage on the timing capacitors constant.

Delay Pickoff. The Delay Pickoff allows a continuously variable delay of 0 to 9.8 times the TIME/DIV OR DLY TIME control setting between the start of the Delaying Sweep Generator and the start of the Delayed Sweep Generator. The Delay Pickoff uses the Delaying Sweep ramp as a time reference by comparing the ramp voltage to a voltage set by the DELAY TIME MULT. When the ramp voltage exceeds the DELAY TIME MULT voltage, a pulse is coupled to the Delayed Trigger Generator.

When a trigger pulse is received from the Main Trigger Generator, Q493 cuts off and Q492 conducts.

As the Delaying Sweep ramp exceeds the voltage on the base of Q482B, Q482A cuts off and Q482B conducts. The differential signal produced when both Q492 and Q482B conduct is coupled to the Delayed Trigger Generator.

Transistor Q494 is a constant current source maintaining a constant voltage across DELAY TIME MULT, R490. When the time base is set for a Normal sweep mode, S490 grounds R499 and cuts off Q494. With Q494 cut off, the voltage at the input (pin 3) of voltage follower U492 is zero. Therefore, in the Normal sweep mode, the Delay Pickoff outputs a pulse as soon as the Main Trigger pulse cuts off Q493.

Delayed Trigger Generator

3

When the Delayed Triggering LEVEL control is in the RUNS AFTER DELAY TIME position, or the time base is in the Normal Sweep mode, the Delayed Trigger Generator outputs a trigger pulse to the Delayed Sweep Generator as soon as the Delay Pickoff pulse is received. If the Delayed Triggering LEVEL control is out of the RUNS AFTER DELAY TIME detent, and the time base is in the Delayed or Alternate sweep modes, the Delayed Trigger Generator is enabled by the Delay Pickoff pulse. The Delayed Trigger Generator then operates much the same as the Main Trigger Generator.

External Source (SN B070000-above). The external trigger signal is connected to the Delayed Trigger Generator through the DLY'D TRIG IN connector, J200. The input impedance at J200 can be set to either 1 megohm or 50 ohms by TERM switch S205.

Input signals below 100 megahertz are coupled through Q222A and Q224 to pin 3 of U274. Input signals above 100 megahertz are coupled through C220 to pin 4 of U274. (Pins 3 and 4 of U274 are internally connected.)

External Source (SN B069999-below). The external trigger signal is connected to the Delayed Trigger Generator through the DLY'D TRIG IN connector, J200. The input impedance at J200 can be set to either 1 megohm or 50 ohms by TERM switch S205.

Input signals below 100 megahertz are coupled through Q222A and Q224 to pin 3 of U264. Input signals above 100 megahertz are coupled through C226 to pin 4 of U264. (Pins 3 and 4 of U264 are internally connected.)

Internal Source (SN B070000-above). When the Delayed Trigger Generator is using an internal trigger signal, the internal trigger signal from the vertical channel of the oscilloscope is connected to the Delayed Trigger Generator through J250. Signals above 30 kilohertz are coupled through C246 to pin 14 of U274. (Pins 13 and 14 of U274 are internally connected.) Signals below 30 kilohertz are connected to amplifier U244 through R257. The output of amplifier U244 is coupled, along with the offset from the LEVEL control, to pin 1 of U274.

Internal Source (SN B069999-below). When the Delayed Trigger Generator is using an internal trigger signal, the internal trigger signal from the vertical channel of the oscilloscope is connected to the Delayed Trigger Generator through J250. Signals above 30 kilohertz are coupled through C246 to pin 14 of U264. (Pins 13 and 14 of U264 are internally connected.) Signals below 30 kilohertz are connected to amplifier U240 through R253. The output of amplifier U240 is coupled, along with the offset from the LEVEL control, to pin 1 of U264.

Slope Selector Amplifier (SN B070000-above). Amplifier U322 selects the slope of the input waveform on which triggering occurs. If pin 3 is high, the time base will trigger on the negative slope. If pin 3 is low, the time base will trigger on the positive slope. (The internal signal is inverted by U274 before being applied to U322.)

Slope Selector Amplifier (SN B069999-below). Amplifier U284 selects the slope of the input waveform on which triggering occurs. If pin 6 is high, the time base will trigger on the negative slope. If pin 6 is low, the time base will trigger on the positive slope. (The internal signal is inverted by U264 before being applied to U284.)

The push-pull outputs (pins 7, 8 and 9, 10) of U284 are connected to the inputs (pins 3 and 13) of U304.

Output Amplifier (SN B069999-below). Amplifier U304 provides a final gain stage before driving the trigger-output tunnel diodes. The push-pull outputs of U304 (pins 8 and 9) drive the emitter and base of Q312. Transistor Q312 converts the push-pull output of U304 to a single-ended output to drive tunnel diode CR314. As the emitter-base voltage of Q312 increases, the current through CR314 increases. When the current through CR314 reaches 10 milliamperes, it switches to its high level. The fast rise of CR314 is coupled through C341 to the Arming Tunnel Diode, CR372, which also switches high. The high level at the anode of CR372 increases the current through the Gate Tunnel Diode, CR376. The rise of CR314 is also coupled through C324 (and a 1 nanosecond delay line) to CR376. The combination of the added current from CR372 and the pulse from CR314 (1 nanosecond later) switches CR376 high. The fast-rise pulse from CR376 is connected to the Delayed Sweep Generator.

Trigger Disable (SN B070000-above). At the end of each Delaying Sweep, the Horizontal Logic produces a Trigger Disable pulse to allow enough time for the sweep generator to reset and stabilize before another trigger pulse starts the next sweep. The Trigger Disable pulse resets the main trigger output to a low level. At the same time U820 pulls pin 3 AUTO high. With pin CF low, and pin AH high (see Delaying Sweep ) , comparators Q402-Q404, Q492-Q493 and Q482A-Q482B reset to Q404, Q492, and Q482B off and Q402, Q493, and Q482A conducting. This resets the differential comparators Q362, Q366 and Q342, Q346 to Q362, Q342 off and Q366, Q346 on. With Q342 off, pin 2 of U322 is high resetting the Delayed Trigger.

Trigger Disable (SN B069999-below). At the end of each Delaying Sweep, the Horizontal Logic produces a Trigger Disable pulse to reset the Arming and Gate Tunnel Diodes to a low level and allow enough time for the sweep generator to reset and stabilize before another trigger

pulse starts the next sweep. The Trigger Disable signal is connected to the base of Q332. When the Trigger Disable pulse is high, Q348 and Q358 turn on, removing the bias current from CR372 and CR376, respectively. With no bias current, CR372 and CR376 both reset to a low level.

Delayed Triggering Modes (SN B070000-above). The Delayed Trigger Generator operates in one of three modes; Normal, Delayed (Runs After Delay Time), and Delayed (Triggerable After Delay Time).

In the Normal mode (both Time/Division knobs locked together), Q328 is cut off and U322 inputs are disabled. When the Delay Pickoff pulse goes high, U322 gate goes high.

In the Delayed (Runs After Delay Time) mode, the Delayed Trigger Generator operates the same as in the Normal mode. However, Q328 is cut off by the RUNS AFTER DELAY TIME switch, S250; but, there is a delay between the time the Delaying Sweep Generator starts and the Delay Pickoff is generated. The Delay Pickoff pulse causes the gate of U322 to go high. In the Delayed (Triggerable After Delay Time) mode, U322 is in the Triggerable mode. Now the Delay Pickoff pulse enables U322 to trigger when a trigger input signal is present.

Delayed Triggering Modes (SN B069999-below). The Delayed Trigger Generator operates in one of three modes; Normal, Delayed (Runs After Delay Time), and Delayed (Triggerable After Delay Time).

In the Normal mode (both Time/Division knobs locked together), Q334 is cut off and U284 and U304 are both disabled. Additional current for CR372 and CR376 is supplied by R335 and R337. When the Delay Pickoff pulse cuts off CR381, CR372 switches high. The fast rise of CR382 is coupled through R373 and C373 to CR376, which also switches high.

In the Delayed (Runs After Delay Time) mode, the Delayed Trigger Generator operates the same as in the Normal mode. However, Q334 is cut off by the RUNS AFTER DELAY TIME switch, S250, and there is a delay between the time the Delaying Sweep Generator starts and the Delay Pickoff pulse cuts off CR381.

In the Delayed (Triggerable After Delay Time) mode, the entire Delayed Trigger Generator is operating, but the Arming Tunnel Diode, CR372, is held low by the Delay Pickoff signal until after the delay time.

When the Delay Pickoff pulse cuts off CR381, the next positive pulse from CR314 sets CR372 high and 1 nanosecond later sets CR376 high.

Delayed Sweep Generator



The Delayed Sweep Generator produces a linear ramp waveform when gated by the Delayed Trigger Generator. The Delayed Sweep ramp is displayed as the Normal or Delayed Sweep trace.

The linear ramp waveform is produced by charging a capacitor from a constant current source. The slope of the ramp determines the time/division of the displayed trace.

Ramp Generator. When a trigger pulse is received from the Delayed Trigger Generator, Q502 cuts off and Q504 conducts, driving the base of Q510 high. When Q510 turns on, Q512 turns off and the timing current from Q536 starts to charge the timing capacitors in a positive ramp. The timing current is determined by the timing resistors in the emitter circuit of Q536 and the reference voltage at the base of Q536. Transistors Q546A and B and Q550 form a unity-gain, voltage follower for the delaying sweep signal. The output of Q550 is attenuated by divider R557 and R558 before it is connected to the Output Amplifier. At 0.5 nanosecond/division, the Delayed Sweep ramp is not attenuated. The output of Q550 also drives the Sweep Stop Comparator and the Baseline Stabilizer.

Sweep Stop Comparator. Transistors Q562 and Q564 control the sweep length. When the Delayed Sweep ramp exceeds the voltage on the base of Q564, Q562 turns off and Q564 provides a positive pulse to end the Main Gate.

Main Gate Generator. When the trigger pulse cuts off Q502, the negative pulse at the base of Q572 causes the Main Gate at the emitter of Q584 to go high. The Main Gate signal remains high until a positive pulse from the Sweep Stop Comparator turns Q568 on, ending the Main Gate.

Baseline Stabilizer. When the Trigger Disable pulse resets the output of the Delayed Trigger Generator to a low level, Q502 turns on and Q504 turns off. The low level on the base of Q510 turns on Q512, which discharges the timing capacitors. With the timing capacitors discharged, the Baseline Stabilizer maintains a constant output level. The output of Q550 is compared with the reference on the base of Q522. If the output is less than the reference, Q530 charges the timing capacitors through CR534 until the output and reference voltages are equal. If the output is greater than the reference, Q530 conducts less and the timing capacitors discharge through Q512. When the two voltages are equal, the currents through Q530 and Q536 equal the current through Q512, which holds the voltage on the timing capacitors constant.

Auxiliary Y and Z Axis. The Aux Y and Aux Z outputs allow the 7B92A to control the trace separation, intensity, and contrast of the Delaying Sweep trace when the time base is operating in the Alternate mode.

The Aux Y, Z Inhibit signal disables both outputs except when the time base is in the Intensified or Alternate modes, and the delaying sweep is being displayed. The CONTRAST control is active when operating in the ALT mode, and the Delayed Sweep Generator is running. The CONTRAST control varies the brightness of the intensified zone.

Horizontal Logic



The Horizontal Logic controls the different sweep modes and functions of the time base (e.g., sweep display, holdoff, auto-trigger, single-sweep, etc.). The Horizontal Logic also generates control signals for the oscilloscope mainframe.

Sweep Control IC. The Sweep Control IC, U820, generates most of the control signals used in the 7B92A.

When the MAIN TRIGGERING MODE is set to AUTO, the Sweep Control IC supplies a triggering gate to the Delaying Sweep Generator when the Main Trigger Generator is not triggered. The auto triggering circuit starts to operate if pin 19 of U820 is held low by S100 and an Auto Disable Pulse has not been received for about 40 milliseconds.

When the MAIN TRIGGERING MODE is set to SINGLE SWEEP, the Sweep Control IC allows one ramp to be displayed. The Trigger Disable signal then prevents another ramp from running until U820 is manually reset by pressing the SINGLE SWEEP-RESET button.

Lockout. When the 7B92A is used in a four-channel oscilloscope mainframe in an Alternate mode with another time base, a Lockout signal prevents the 7B92A from running while the other time base is being displayed. The Lockout signal is coupled through the Lockout Amplifier, Q802, Q804, and Q806 to pin 18 of U820. The Lockout signal drives the Trigger Disable output (pin 17) high to reset and hold the trigger generator outputs low.

The 7B92A also outputs a Holdoff pulse (pin B4) to the oscilloscope mainframe which controls the Lockout pulse to the other time base. The Holdoff pulse occurs at the end of each Delaying Sweep ramp when the time base is in the Normal, Intensified or Delayed Sweep mode. When the time base is in the Alternate mode, the Holdoff pulse occurs after the Delayed Sweep ramp is displayed.

NOTE

When operating in the Intensified mode, the intensified zone is controlled by the intensity of the test oscilloscope instead of the 7B92A CONTRAST and INTENSITY controls.

Sweep Display. The Sweep Display flip-flop, U856A, determines which sweep ramp is displayed. When the time base is in the Normal or Delayed Sweep mode, S800 connects R861 and R862 to ground. With the Set input of U856A low, pin 5 is held high and pin 6 is held low. The high level on pin 5 of U856A inhibits the Delaying Sweep signal at the Output Amplifier. The low on pin 6 allows the Delayed Sweep signal to be coupled through the Output Amplifier to the oscilloscope mainframe.

If the time base is in the Alternate mode, the Set, J, and K inputs of U856A are all high. The end of each Aux. Gate pulse toggles U856A, which allows alternate display of the Delaying and Delayed Sweep ramps.

When the time base is in the Intensified Sweep mode, pin 15 of U856A is held low by pin 4 of U635, clearing flip-flop U856. With pin 5 of U856A low, the Delaying Sweep signal is coupled to the output amplifier.

Output Amplifier

The Output Amplifier connects the sweep signal to the oscilloscope mainframe and provides an offset voltage to position the trace on the graticule.

The Delaying Sweep and Delayed Sweep ramps are connected to Q900 and Q910, respectively. The Delaying Sweep Inhibit and Delayed Sweep Inhibit signals saturate either Q902 or Q912 to prevent that sweep ramp from being amplified and coupled to the oscilloscope mainframe.

The POSITION control, R930, offsets the ramp waveform to horizontally position the displayed trace. Transistors Q926 and Q932 turn on when contact 52 is closed and the Delaying Sweep Inhibit signal is high. These transistors provide additional offset at fast sweep rates.

The positioning offset voltage and the selected sweep ramp are connected to Q942 and Q952. The push-pull output is connected to the oscilloscope mainframe through pins A11 and B11.

The Auxiliary Sweep Amplifier, Q456 and Q458, is a unity-gain amplifier that couples the Delaying Sweep ramp to the mainframe. This signal may be connected to the + Sawtooth output of the oscilloscope mainframe.

Readout

The oscilloscope readout system in 7000-Series Oscilloscopes provides alphanumeric display of information encoded by the plug-in units. This display is presented on the crt on a time-shared basis with the waveform display.

The oscilloscope readout system produces a pulse train consisting of 10 negative-going pulses called time-slots. Each pulse represents a possible character in a readout word, and is assigned a time-slot number corresponding to its position in the word. Each time-slot pulse is directed to 1 of 10 lines, labeled TS-1 through TS-10 (time slots 1 through 10), which are connected to the vertical and horizontal plug-in compartments. Two output lines, row and column, are connected from each channel (two channels per plug-in compartment) back to the oscilloscope readout system.

Data is encoded on the output lines either by connecting resistors between the output lines and the time-slot input lines, or by generating equivalent currents. The resultant output is a sequence of analog current levels on the row and column output lines. The row and column current levels address a character matrix during each time-slot; thus, selecting a character to be displayed or a special instruction to be followed.

The encoding resistors are selected by the TIME/DIV OR DLY TIME and DLY'D Time/Division switches. Table 3-1 lists the resistors that control the readout characters and functions.

Table 3-1
7B92A READOUT CHARACTER SELECTION

Characters	Time-Slot	Description	Encoded	
			Channel (Delaying Sweep)	Channel (Delayed Sweep)
Decimal	TS-1	Determines decimal magnitude (number of zeros displayed or prefix change information).	R761, R762 R781	R771, R772 R791
Uncalibrated (>)	TS-3	Indicates calibrated or uncalibrated sweep rates	R782	R792
1, 2, 5	TS-4	Scaling	R763, R764 R785	R773, R774 R793
m, μ , n, p	TS-8	Defines the prefix which modifies the units of measurement	R765, R766 R783, R786	R775, R776 R788, R795
s (seconds)	TS-9	Defines the unit of measurement	R784, R787	R789, R796

MAINTENANCE

This section of the manual contains information for performing preventive maintenance, troubleshooting, and corrective maintenance for this instrument.

PREVENTIVE MAINTENANCE

Preventive maintenance consists of cleaning, visual inspection, lubrication, etc. Preventive maintenance performed on a regular basis may prevent instrument breakdown and will improve the reliability of the instrument. The severity of the environment to which this instrument is subjected determines the frequency of maintenance. A convenient time to perform preventive maintenance is preceding adjustment of the instrument.

CLEANING

This instrument should be cleaned as often as operating conditions require. Accumulation of dirt on components acts as an insulating blanket and prevents efficient heat dissipation that can cause overheating and component breakdown.

CAUTION

Avoid the use of chemical cleaning agents which might damage the plastics used in this instrument. In particular, avoid chemicals that contain benzene, toluene, xylene, acetone, or similar solvents.

Exterior

Loose dust accumulated on the front panel can be removed with a soft cloth or small brush. Dirt that remains can be removed with a soft cloth dampened with a mild detergent and water solution. Abrasive cleaners should not be used.

Interior

Dust in the interior of the instrument should be removed occasionally due to its electrical conductivity under high-humidity conditions. The best way to clean the interior is to blow off the accumulated dust with dry, low-pressure air. Remove any dirt that remains with a soft brush or a cloth dampened with a mild detergent and water solution. A cotton-tipped applicator is useful for cleaning in narrow spaces.

Switch Contacts

Switch contacts and pads are designed to operate dry for the life of the switch. However, as the switches are not sealed, dust attracted to the contact area may cause switch contacts to become electrically noisy. Cleaning may be accomplished by flushing the contact area with isopropyl alcohol or kelite (1 part kelite to 20 parts water). Do not use chemical cleaning agents that leave a film or that might damage plastic parts. Do not use cotton swabs or similar applicators to apply cleaning agents, as they tend to snag and leave strands of cotton on switch contacts. Should it become necessary to remove a switch for replacement or cleaning, refer to Component Removal and Replacement in this section.

VISUAL INSPECTION

This instrument should be inspected occasionally for such defects as broken connections, improperly seated semiconductors, damaged circuit boards, and heat-damaged parts.

The corrective procedure for most visible defects is obvious; however, particular care must be taken if heat-damaged components are found. Overheating usually indicates other trouble in the instrument; therefore, it is important that the cause of overheating be corrected to prevent recurrence of the damage.

LUBRICATION

Generally, there are no components in this instrument that require a regular lubrication program during the life of the instrument.

Cam Switch Lubrication

In most cases, factory lubrication should be adequate for the life of the instrument. However, if the switch has been disassembled for replacement of switch sub-parts, a lubrication kit containing the necessary lubricating materials and instructions is available through any Tektronix Field Office. Order Tektronix Part 003-0342-01. General Electric Versilube® silicone grease should be applied sparingly so that the lubricant does not get on the contacts. Refer to Fig. 4-1 for lubrication instructions.

SEMICONDUCTOR CHECKS

Periodic checks of the semiconductors in this instrument are not recommended. The best check of semiconductor performance is actual operation in the instrument. More details on checking semiconductor operation are given under Troubleshooting.

ADJUSTMENT AFTER REPAIR

After any electrical component has been replaced, the adjustment of that particular circuit should be checked, as well as the adjustment of other closely-related circuits. The Performance Check and Adjustment procedure in this manual provides a quick and convenient means of checking instrument operation. In some cases, minor troubles may be revealed or corrected by adjustment.

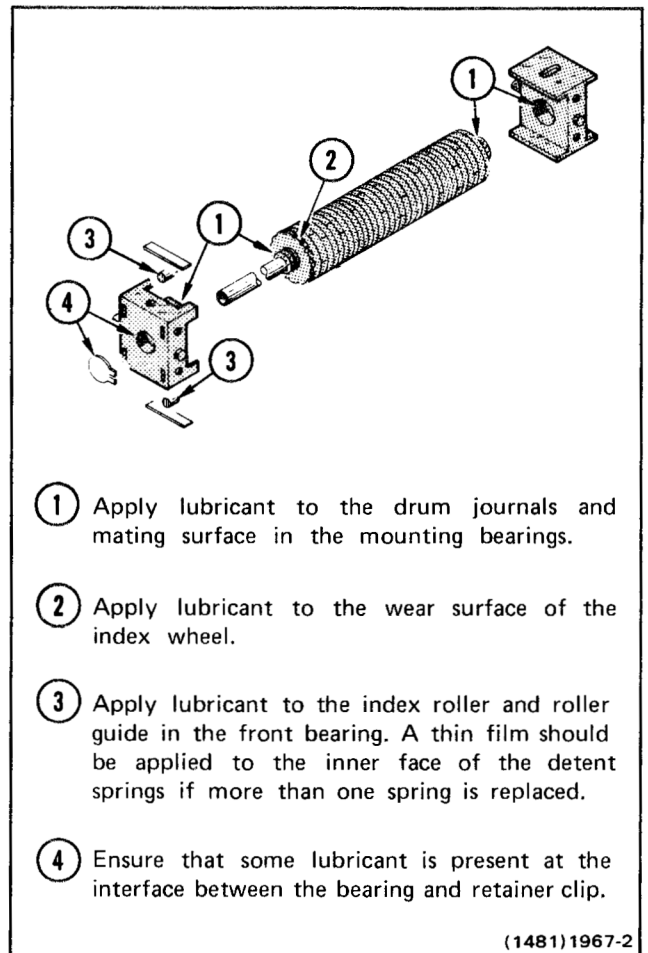

Fig. 4-1. Lubrication procedure for a typical cam switch.

TROUBLESHOOTING

The following information is provided to help troubleshoot this instrument. Information contained in other sections of this manual should be used along with the following information to aid in locating the defective component. An understanding of the circuit operation is very helpful in locating troubles, particularly where integrated circuits are used.

TROUBLESHOOTING AIDS

Diagrams

Circuit diagrams are given on foldout pages in Section 8. The component number and electrical value of each component in this instrument is shown on the diagrams. Components that are mounted on circuit boards are outlined on the diagrams with a heavy black line.

Voltages and Waveforms

Typical operating voltages are shown on the diagrams. Voltage Conditions given on the diagram page indicate the test equipment used and the front-panel control status necessary to obtain the given voltages.

Typical operating waveforms are shown next to the diagram where they were measured. Each waveform is numbered to locate the point on the diagram where the waveform was taken. Waveform Conditions given on the diagram page list the test equipment used and the front-panel control status necessary to obtain the given waveform.

Circuit Board Illustrations

Circuit board illustrations are shown on the foldout page preceding the associated diagram. Each board-mounted electrical component is identified by its circuit number, as are interconnecting wires and connectors.

Figure 8-1, in the front of the diagrams section, shows the location and assembly number of each circuit board in this instrument.

Switch Cam Identification

Switch cam numbers shown on diagrams indicate the position of each cam in the complete switch assembly. The switch cams are numbered from front to rear.

Diode Color Code

The cathode end of each glass-encased diode is indicated by a stripe, a series of stripes, or a dot. The cathode and anode ends of metal-encased diodes are identified by the diode symbol marked on the case. For most silicon or germanium diodes with a series of stripes, the color code identifies the four significant digits of the JEDEC or vendor number using the resistor color-code system.

Wiring Color Code

Insulated wire and cable used in this instrument is color-coded to facilitate circuit tracing.

Semiconductor Basing

Figure 4-2 illustrates the basing configurations for all semiconductors used in this instrument. Some plastic-case transistors have lead configurations that do not agree with those shown here. If a replacement transistor is made by a different manufacturer than the original, check the manufacturer's basing diagram. All transistor sockets in this instrument are wired for the standard basing used for metal-case transistors.

Inter-Board Pin Connector Identification

The inter-board pin connector sockets are installed on circuit boards in groups of 5 sockets (as in Fig. 4-3). Socket number 1 is indexed on the circuit board with either a triangular mark or the number 1. Each group of sockets is identified by its J (jack) number etched on the circuit board. The J numbers correlate to the J (jack) and P (plug) circuit numbers on the schematic diagrams.

NOTE
LEAD CONFIGURATIONS AND CASE STYLES ARE TYPICAL, BUT MAY VARY DUE TO VENDOR CHANGES OR INSTRUMENT MODIFICATIONS.

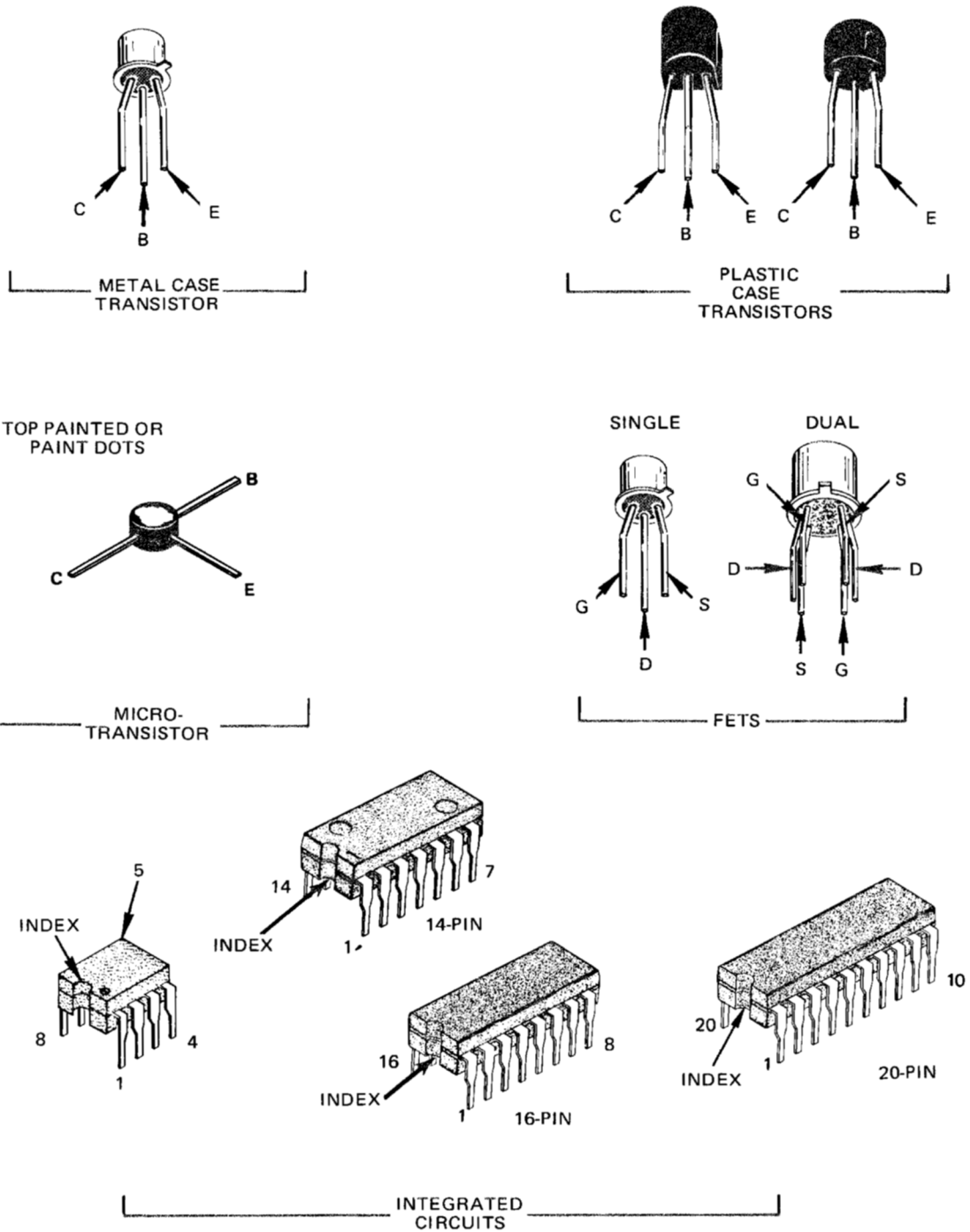

1751-9B

Fig. 4-2. Semiconductor lead configurations.

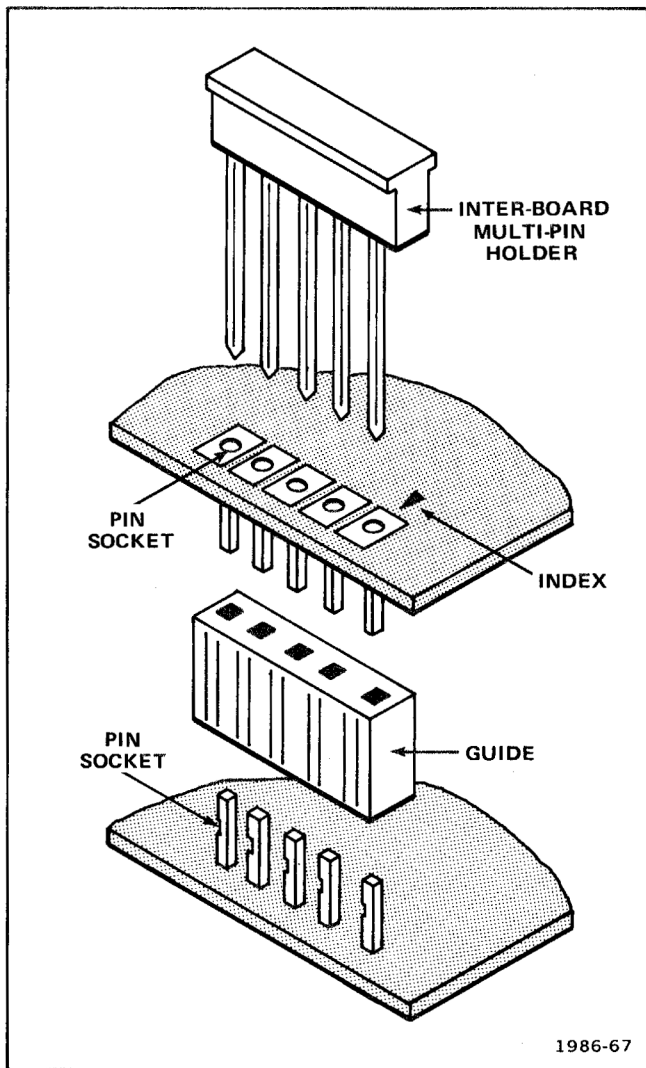

Fig. 4-3. Inter-board multi-pin connector assembly.

Multi-Pin Connector Identification

Multi-pin connectors mate with groups of pins soldered to circuit boards. Pin number 1 is indexed with a triangular mark on the circuit board and molded on the holder of the multi-pin connector, as shown in Fig. 4-4. Each group of pins is identified by its corresponding J number etched on the circuit board. The J numbers, on the circuit boards, correlate to the J and P component numbers on the schematic diagrams.

Interface Connector Pin Locations

The Interface circuit board couples the plug-in unit to the associated mainframe (oscilloscope). Figure 4-5 identifies the pins on the interface connector as shown on Interface Connectors and Power Supply diagram 8 in the Diagrams section.

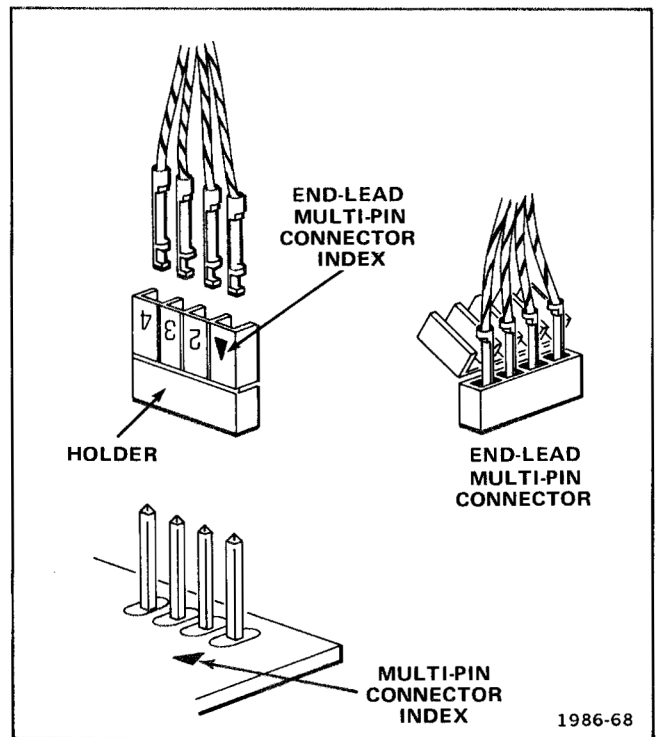

Fig. 4-4. End-lead multi-pin connector assembly.

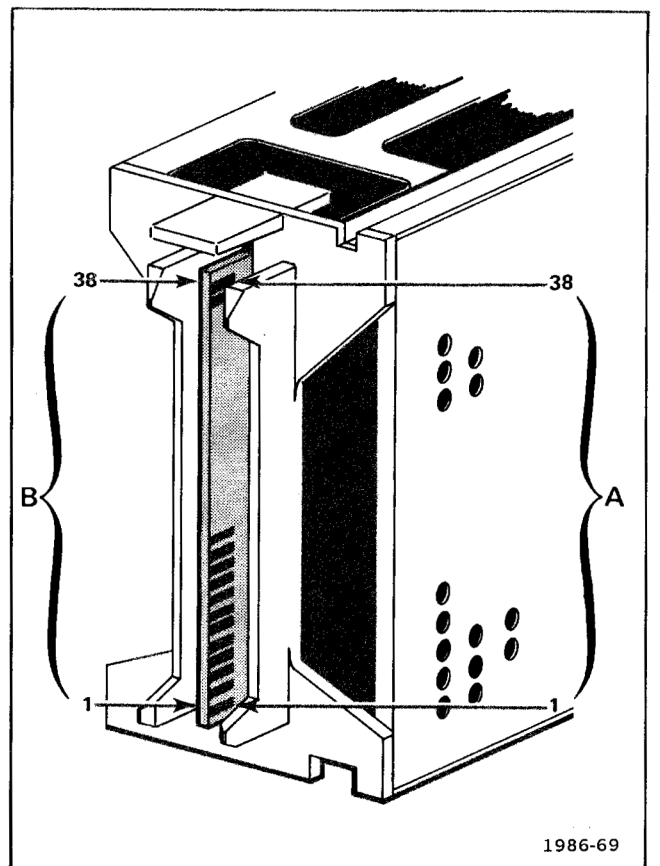

Fig. 4-5. Location of pin numbers of Interface connector.

Performance Check and Adjustment

The Performance Check and Adjustment procedure, given in Section 5 of this manual, provides a quick and convenient means of checking instrument operation. In some cases, minor troubles may be revealed or corrected by adjustment.

TROUBLESHOOTING EQUIPMENT

The following equipment, in addition to that listed in the Performance Check and Adjustment section, is useful for troubleshooting.

Transistor Tester.

Description: Dynamic-type tester.

Purpose: Test semiconductors.

Recommended Tektronix types: 576 Curve Tracer, 577/177 Curve Tracer system, 7CT1N Curve Tracer unit and a 7000-Series Oscilloscope system, or a 5CT1N Curve Tracer unit and a 5000-Series Oscilloscope.

Multimeter.

Description: Voltmeter, 10 megohm input impedance and a range from 0 to at least 50 volts dc; accuracy, within 0.1%. Ohmmeter, 0 to 20 megohms. Test probes should be insulated to prevent accidental shorting.

Purpose: Check voltage and resistance.

Test Oscilloscope.

Description: Frequency response, dc to 100 megahertz minimum; deflection factor, 5 millivolts to 5 volts/division. A 10X, 10 megohm voltage probe should be used to reduce circuit loading.

Purpose: Check operating waveforms.

TROUBLESHOOTING TECHNIQUES

The following troubleshooting procedure is arranged to check the simple trouble possibilities before proceeding with extensive troubleshooting. The first few checks ensure proper connection, operation, and adjustment. If the trouble is not located by these checks, the remaining steps aid in locating the defective component. When the defective component is located, it should be replaced using the replacement procedure given under Corrective Maintenance.

Troubleshooting Procedure

1. Check Control Settings. Incorrect control settings can indicate a trouble that does not exist. If there is any question about the correct function or operation of any control, see the Operating Instructions, Section 2.

2. Check Associated Equipment. Before troubleshooting, check that the equipment used with this instrument is operating correctly. Check that the signal is properly connected and that the interconnecting cables are not defective. Also, check the power source. If the trouble persists, the time-base unit is probably at fault.

3. Visual Check. Visually check the portion of the instrument in which the trouble is located. Many troubles can be located by visible indications such as unsoldered connections, broken wires, damaged circuit boards, damaged components, etc.

4. Check Instrument Adjustment. Check the adjustment of this instrument, or the affected circuit if the trouble appears in one circuit. The apparent trouble may be the result of misadjustment. Complete adjustment instructions are given in the Performance Check and Adjustment section.

5. Isolate Trouble to a Circuit. To isolate trouble to a circuit, note the trouble symptom. The symptom often identifies the circuit in which the trouble is located. When trouble symptoms appear in more than one circuit, check the affected circuits by taking voltage and waveform readings. Incorrect operation of all circuits often indicates trouble in the power supply. Check first for correct voltages of the individual supplies. However, a defective component elsewhere in the instrument can appear as a power-supply trouble and may also affect the operation of other circuits.

After the defective circuit has been located, proceed with steps 6 and 7 to locate the defective component(s).

6. Check Voltages and Waveforms. Often the defective component can be located by checking for the correct voltages and waveforms in the circuit. Refer to the diagrams section at the rear of the manual for typical voltages and waveforms.

NOTE

Voltages and waveforms given on the diagrams are not absolute and may vary slightly between instruments. To obtain operating conditions similar to those used to take these readings, see the voltage

and waveforms page adjacent to each schematic diagram. Note the recommended test equipment, front-panel control settings, voltage and waveform conditions, and test equipment cable connection instructions.

7. Check Individual Components. The following procedures describe methods for checking individual components. Two-lead components that are soldered in place are best checked by first disconnecting one end. This isolates the measurement from the effects of surrounding circuitry.

CAUTION

To avoid component damage, disconnect the power source before removing or replacing semiconductors.

TRANSISTORS. The best check of transistor operation is actual performance under operating conditions. A transistor can be most effectively checked by substituting a new component or one that has been checked previously. However, be sure that circuit conditions are not such that a replacement transistor might also be damaged. If substitute transistors are not available, use a dynamic tester. Static-type testers are not recommended, since they do not check operation under simulated operating conditions.

INTEGRATED CIRCUITS. Check with a voltmeter, test oscilloscope, or by direct substitution. A good understanding of circuit operation is desirable when troubleshooting circuits using IC. Use care when checking voltages and waveforms around the IC so that adjacent leads are not shorted together. A convenient means of clipping a test probe to the 14- and 16-pin IC is with an IC test clip. This device also serves as an extraction tool. The lead configuration for the semiconductors used in this instrument is shown on a pullout page in the front of the diagrams section.

CAUTION

Do not use an ohmmeter scale that has a high internal current. High currents may damage the diode.

DIODES. A diode can be checked for an open or shorted condition by measuring the resistance between terminals with an ohmmeter scale having a low internal source current, such as the R X 1K scale. The resistance should be very high in one direction and very low when the meter leads are reversed.

The cathode end of each glass-encased diode is indicated by a stripe, a series of stripes, or a dot. The cathode and anode ends of metal-encased diodes are identified by the diode symbol marked on the case. For most silicon or germanium diodes with a series of stripes, the color code identifies the four significant digits of the JEDEC or vendor number using the resistor color-code system.

RESISTORS. Check resistors with an ohmmeter. See the Replaceable Electrical Parts list for the tolerance of the resistors used in this instrument. Resistors normally do not need to be replaced unless the measured value varies widely from that specified.

INDUCTORS. Check for open inductors by checking continuity with an ohmmeter. Shorted or partially shorted inductors can usually be found by checking the waveform response when high-frequency signals are passed through the circuit. Partial shorting often reduces high-frequency response.

CAPACITORS. A leaky or shorted capacitor can usually be detected by checking resistance with an ohmmeter on the highest scale. Do not exceed the voltage rating of the capacitor. The resistance reading should be high after initial charge of the capacitor. An open capacitor can best be detected with a capacitance meter or by checking that the capacitor passes ac signals.

8. Repair and Adjustment. If any defective parts are located, follow the replacement procedures given in Corrective Maintenance. Be sure to check the performance of any circuit that has been repaired or had any electrical components replaced.

CORRECTIVE MAINTENANCE

Corrective maintenance consists of component replacement and instrument repair. Special techniques required to replace components in this instrument are given here.

OBTAINING REPLACEMENT PARTS

All electrical and mechanical part replacements can be obtained through your Tektronix field Office or representative. However, many of the standard electronic components can be obtained locally in less time than is required to order them from Tektronix, Inc. Before purchasing or ordering replacement parts, check the parts list for value, tolerance, rating, and description.

NOTE

When selecting replacement parts, remember that the physical size and shape of a component may affect the performance of the instrument, particularly at high frequencies. All parts should be direct replacements unless a different component will not adversely affect instrument performance.

Some parts are manufactured or selected by Tektronix, Inc. to satisfy particular requirements, or are manufactured to specifications for Tektronix, Inc. Most of the mechanical parts used in this instrument have been manufactured by Tektronix Inc. To determine the manufacturer of parts, refer to parts list, Cross Index Mfr. Code Number to Manufacturer.

When ordering replacement parts from Tektronix, Inc., include the following information:

1. Instrument type.
2. Instrument serial number.
3. A description of the part (if electrical, include circuit number).
4. Tektronix part number.

SOLDERING TECHNIQUES

WARNING

To avoid electrical shock, disconnect the instrument from the power source before soldering.

The reliability and accuracy of this instrument can be maintained only if proper soldering techniques are used when repairing or replacing parts. General soldering techniques, which apply to maintenance of any precision electronic equipment, should be used when working on this instrument. Use only 60/40 rosin-core, electronic-grade solder. The choice of soldering iron is determined by the repair to be made. When soldering on circuit boards, use a 15- to 40-watt pencil-type soldering iron with a 1/8-inch wide wedge-shaped tip. Keep the tip properly tinned for best heat transfer to the solder joint. A higher wattage soldering iron may separate the wiring from the base material. Avoid excessive heat; apply only enough heat to remove the component or to make a good solder joint. Also, apply only enough solder to make a firm solder joint; do not apply too much solder.



All circuit boards, except the Readout circuit board, in this instrument are multi-layer type boards with a conductive path(s) laminated between the top and bottom board layers. All soldering on these boards should be done with extreme care to prevent breaking the connections to the center conductor(s); only experienced maintenance personnel should attempt repair of these boards.

For metal terminals (e.g., switch terminals, potentiometers, etc.), a higher wattage-rating soldering iron may be required. Match the soldering iron to the work being done. For example, if the component is connected to the chassis or other large heat-radiating surface, it will require a 75-watt or larger soldering iron.

The following techniques should be used to replace a component on a circuit board:

1. Grip the component lead with long-nose pliers. Touch the soldering iron to the lead at the solder connection. Do not lay the iron directly on the board, as it may damage the board.

2. When the solder begins to melt, gently pull the lead out. If unable to pull out the lead without using force, try removing the other end of the component as it may be more easily removed.

NOTE

The reason some component leads are troublesome to remove is due to a bend placed on each lead during the manufacturing process. The bent leads hold components in place during a process that solders many components at one time.

If a component lead is extremely difficult to remove, it may be helpful to straighten the leads on the back side of the board with a small screwdriver or pliers while heating the soldered connection.

Use only enough heat to remove the component lead without removing the solder from the board. If it is desired to remove solder from a circuit-board hole for easier installation of a new component, a solder-removing wick should be used.

3. Bend the leads of the new component to fit the holes in the board. If the component is replaced while the board is mounted in the instrument, cut the leads so they will just protrude through the board. Insert the leads into the holes so the component is firmly seated against the board (or as positioned originally). If it does not seat properly, heat the solder and gently press the component into place.

4. Touch the iron to the connection and apply a small amount of solder to make a firm solder joint. To protect heat-sensitive components, hold the lead between the component body and the solder joint with a pair of long-nose pliers or other heat sink.

5. Clip any excess lead protruding through the board (if not clipped in step 3).

6. Clean the area around the solder connection with a flux-removing solvent. Be careful not to remove information printed on the board.

Component Removal and Replacement**WARNING**

Disconnect the instrument from the power source before replacing components.

Semiconductors. Semiconductor devices used in this instrument should not be replaced unless actually defective. If removed from their sockets during routine maintenance, return them to their original sockets. Ferrite beads must be reinstalled on the proper leads.

Unnecessary replacement may affect the calibration of this instrument. When a semiconductor is replaced, check the operation of the part of the instrument that may be affected.

Replacement devices should be of the original type or a direct replacement. Install in the same manner as the original. Figure 4-2 shows the lead configurations of the semiconductor devices used in this instrument. When replacing, check the manufacturer's basing diagram for correct basing.

Interconnecting Pins. Two methods of interconnection are used in this instrument to connect the circuit boards with other boards and components. When the interconnection is made with a coaxial cable, a special end-lead connector plugs into a socket on the board. Other interconnections are made with a pin soldered onto the board. Two types of mating connectors are used for these interconnecting pins. If the mating connector is mounted on a plug-on circuit board, a special socket is soldered into the board. If the mating connector is on the end of a lead, an end-lead pin connector that mates with the interconnecting pin is used. The following information provides the replacement procedure for the various interconnecting methods.

COAXIAL-TYPE END-LEAD CONNECTORS. Replacement of the coaxial-type end-lead connectors requires special tools and techniques. Only experienced maintenance personnel should attempt replacement of these connectors. It is recommended that the cable or wiring harness be replaced as a unit. For cable or wiring harness part numbers, see the Replaceable Mechanical Parts list. An alternate solution is to refer the replacement of the defective connector to your Tektronix Field Office or representative.

CIRCUIT BOARD PINS AND PIN SOCKETS. A circuit board pin replacement kit, including necessary tools, instructions, and replacement pins, is available from Tektronix, Inc. (Tektronix Part Number 040-0542-00.)

CAUTION

The following procedures are recommended for single-layer circuit boards only. Pin and socket replacement on multi-layer circuit boards should be performed only by qualified service personnel. Refer to your local Tektronix Field Office or Service Center.

The pin sockets on the circuit boards are soldered to the board. To replace one of these sockets, first unsolder the pin socket (use vacuum-type desoldering tool to

Maintenance—7B92A

remove the excess solder). Then straighten the tabs on the socket and remove it from the hole in the board. Place the new socket in the circuit board hole and press the tabs down against the board. Solder the tabs of the socket to the circuit board; be careful not to get solder into the socket.

END-LEAD PIN CONNECTORS. The pin connectors used to connect the wires to the interconnecting pins are clamped to the ends of the associated leads. To replace damaged end-lead pin connectors, remove the old connector from the end of the lead and clamp the replacement connector to the lead.

Some of the pin connectors are grouped together and mounted in a plastic holder; the overall result is that these connectors are removed and installed as a multi-pin connector. To provide correct orientation of this multi-pin connector when it is replaced, an arrow (or dot) is stamped on the circuit board and a matching arrow is molded into the plastic housing of the multi-pin connector. Be sure that these arrows are aligned when the multi-pin connector is replaced. If the individual end-lead pin connectors are removed from the plastic holder, note the color of the individual wires for replacement.

Switches. Pushbutton and cam-type switches are used in the 7B92A. Contact alignment and spacing is critical to the operation of these switches. Therefore, defective switches should be replaced as a unit or repaired only by personnel experienced with switches of this type. Your local Tektronix, Inc. Field Office can provide additional repair information and instructions.

CAM SWITCH. The cam switch (TIME/DIV OR DLY TIME and DLY'd Time/Division) consists of two rotating cams and the associated contacts mounted on the Interface and Readout boards. The cam switch can be disassembled for cleaning, repair, or replacement; however, it is recommended that the cam assembly be removed from the instrument as a unit.

Remove the cam switch as follows:

1. Set the TIME/DIV OR DLY TIME and DLY'D Time/Division switches to 0.2 s and press the knob in.
2. Press and release the VARIABLE knob.
3. Loosen the set screws and remove the VARIABLE and DLY'D Time/Division knobs.

4. Loosen the set screw in the clear plastic flange (behind sub-panel) and remove the TIME/DIV OR DLY TIME flange.

5. Remove the pin connector from the micro-switch (in front of the cam) to the front of the Interface board.

6. Remove the Sweep Logic board.

7. Remove the 11 mounting screws holding the cam-switch assembly to the Interface board. Do not remove the mounting screws from the Readout board.

8. Carefully lift the cam-switch assembly and Readout board from the interconnecting pins at the rear of the Readout board.

9. To replace the cam-switch assembly, reverse the above procedure. Be sure to replace the TIME/DIV OR DLY TIME flange and the DLY'D Time/Division knob in the same position from which they were removed.

TRIGGERING SWITCHES. Remove the Main and Delayed Triggering switches as follows:

1. Perform steps 1 through 4 of the cam-switch replacement procedure.

2. Loosen the set screws and remove all front panel knobs except the DELAY TIME MULT dial.

3. Unsnap the front panel from the top and bottom of the subpanel.

4. Remove the spring from the 7B92A release latch.

5. Remove the 4 screws holding the subpanel to the chassis and pull the subpanel forward.

6. Remove all necessary multi-pin and coaxial connectors.

7. Remove the mounting screws from the desired switch(es).

8. The MAIN TRIGGERING switches must be removed as an assembly (all three switches) and then disassembled further.

9. To replace the triggering switches, reverse the above procedure.

ADJUSTMENT AFTER REPAIR

After any electrical component has been replaced, the adjustment of that particular circuit should be checked, as well as other closely related circuits. See Adjustment section for a complete adjustment procedure.

REPACKAGING FOR SHIPMENT

If the Tektronix instrument is to be shipped to a Tektronix Service Center for service or repair, attach a tag showing: owner (with address) and the name of an individual at your firm that can be contacted. Include com-

plete instrument serial number and a description of the service required.

Save and re-use the package in which your instrument was shipped. If the original packaging is unfit for use or not available, repackage the instrument as follows:

Surround the instrument with polyethylene sheeting to protect the finish of the instrument. Obtain a carton of corrugated cardboard of the correct carton strength and having inside dimensions of no less than six inches more than the instrument dimensions. Cushion the instrument by tightly packing three inches of dunnage or urethane foam between carton and instrument, on all sides. Seal carton with shipping tape or industrial stapler.

The carton test strength for your instrument is 200 pounds.

PERFORMANCE CHECK/CALIBRATION

PRELIMINARY INFORMATION

Calibration Interval

To ensure instrument accuracy, check the calibration of the 7B92A every 1000 hours of operation, or every six months if used infrequently. Before complete calibration, thoroughly clean and inspect this instrument as outlined in the Maintenance section.

Tektronix Field Service

Tektronix, Inc. provides complete instrument repair and recalibration at local Field Service Centers and the Factory Service Center. Contact your local Tektronix Field Office or representative for further information.

Using This Procedure

Outline. To aid in locating a step in the Performance Check or Calibration procedure, outlines are given preceding Part I—Performance Check and Part II—Calibration procedure.

Performance Check. The performance of this instrument can be checked without removing the covers or making internal adjustments by performing Part I—Performance Check. This procedure does not check every facet of the instrument's calibration; but is concerned primarily with those portions of the instrument essential to measurement accuracy and correct operation.

Calibration Procedure. Completion of Part II—Calibration procedure ensures that this instrument meets the electrical specifications given in the Operators manual. Where possible, instrument performance is checked before an adjustment is made. For best overall instrument performance when performing a complete calibration procedure, make each adjustment to the exact setting, even if the Check— is within the allowable tolerance.

Partial Calibration. A partial calibration is often desirable after replacing components, or to touch up the adjustment of a portion of the instrument between major recalibrations.

The Calibration procedure is divided into Triggering Calibration and Sweep Calibration. To perform a partial calibration, start at the beginning of the desired section. To prevent unnecessary recalibration of other parts of the instrument, readjust only if the tolerance given in the Check— part of the step is not met.

TEST EQUIPMENT REQUIRED

The following test equipment and accessories, or their equivalents, are required for complete calibration of the 7B92A. Specifications given for the test equipment are the minimum necessary for accurate calibration. Therefore, some of the specifications listed here may differ from the actual performance capabilities of the test equipment. All test equipment is assumed to be correctly calibrated and operating within the listed specifications. Detailed operating instructions for the test equipment are not given in this procedure. Refer to the test equipment instruction manual if more information is needed.

If only a Performance Check procedure is performed, not all of the listed test equipment will be required. Items used only for the Calibration procedure are indicated by footnote 1. The remaining pieces of equipment are items common to both the Performance Check and the Calibration procedure.

Special Calibration Fixtures

Special Tektronix calibration fixtures are used only where they facilitate instrument calibration. These special calibration fixtures are available from Tektronix, Inc. Order by part number through your local Tektronix Field Office or representative.

Calibration Equipment Alternatives

The Calibration procedure is based on the first item of equipment given as an example of applicable equipment. When other equipment is substituted, control settings or calibration setup may need to be altered slightly to meet the requirements of the substitute equipment. If the exact item of test equipment is not available, first check the Minimum Specifications column in Table 5-1 carefully to see if any other equipment is available that might suffice.

Table 5-1
TEST EQUIPMENT

Description	Minimum Specifications	Purpose	Examples of Applicable Test Equipment
1. Oscilloscope	Bandwidth 500 MHz.	Used throughout procedure to provide a display.	TEKTRONIX 7904 Oscilloscope.
2. Wide-Band Amplifier Plug-In Unit	Bandwidth 500 MHz; Deflection factor 50 mV to 5 V.	Used throughout procedure to provide vertical input to oscilloscope system.	TEKTRONIX 7A19 Amplifier plug-in unit.
3. Fast-Rise Pulse Generator ¹	200 mV positive-going output pulse; risetime 1 ns or less.	Time position check and adjustment.	TEKTRONIX PG 506 Calibration Generator. ²
4. Time-Mark Generator	Marker outputs, 2 ns to 0.5 s within 0.1%.	Sweep timing checks and adjustments. Sweep delay checks and adjustments.	a. TEKTRONIX TG 501 Time-Mark Generator. ² b. TEKTRONIX 2901 Time-Mark Generator.
5. Low-Frequency Sine-wave Generator	Frequency, 30 Hz to 50 kHz; output amplitude, variable from 200 mV to 8 V.	Low-frequency triggering checks and adjustments.	a. TEKTRONIX FG 503 Function Generator. ² b. General Radio 1310-B Oscillator.
6. Medium-Frequency Signal Generator	Frequency, 20 MHz to 100 MHz; output amplitude, variable from 100 mV to 500 mV.	20 MHz triggering checks.	a. TEKTRONIX SG 503 Sine-Wave Generator. ² b. TEKTRONIX 191 Sine-Wave Generator.
7. High-Frequency Signal Generator	Frequency, 245 MHz to 1000 MHz; output amplitude variable from 0.5 V to 4 V.	High-frequency triggering checks. Hf sync operation checks. Trigger jitter checks.	a. TEKTRONIX SG 504 Leveled Sine-Wave Generator. ² b. Wavetek 1002 Sweep/Signal Generator. c. General Radio 1362 UHF Oscillator with 1263-C Amplitude-Regulating Power Supply.
8. Digital Voltmeter	Range 0 to 50 V; accuracy within 0.1%.	Used throughout procedure for voltage checks.	TEKTRONIX DM 501 ¹ Digital Multimeter.
9. Termination	Impedance 50 Ω ; accuracy, within 2%; connectors, bnc.	Output termination for fast-rise generator.	Tektronix Part No. 011-0049-01.
10. Plug-In Extender ¹	Provides access to 7B92A adjustments.	Used throughout procedure to provide access to internal adjustments and test points.	Tektronix Part No. 067-0589-00 Calibration Fixture.
11. Tee Connector	Connectors, bnc.	External trigger checks, adjustments. Hf sync operation checks. Trigger jitter checks.	Tektronix Part No. 103-0030-00.

Table 5-1 (cont)

Description	Minimum Specifications	Purpose	Examples of Applicable Test Equipment
12. Cable	Impedance, 50 Ω ; type RG-58/U; length, 18 inches; connectors, bnc.	Used throughout procedure for signal interconnection.	Tektronix Part No. 012-0076-00.
13. Cable	Impedance, 50 Ω ; type RG-58/U; length 42 inches; connectors, bnc.	Used throughout procedure for signal interconnection	Tektronix Part No. 012-0057-01.
14. Screwdriver	Three-inch shaft, 3/32 inch bit.	Used to adjust variable resistors.	Xcelite R-3323.
15. Low Capacitance ¹ Screwdriver	1-1/2 inch shaft.	Used to adjust variable capacitors.	Tektronix Part No. 003-0000-00.

¹Used for calibration only; NOT used for performance check.

²Requires a TM 500-Series Power Module.

PART I—PERFORMANCE CHECK

The following procedure is intended to be used for inspection and periodic calibration checks to confirm that the 7B92A is operating within acceptable limits. This procedure is concerned with those portions of the instrument calibration that are essential to measurement accuracy and correct operation. Removal of the side covers is not necessary to perform this procedure in that all checks are made from the front panel.

OUTLINE FOR PART I— PERFORMANCE CHECK

		Page
A. Trigger Sensitivity	Page	
1. Check Main Triggering Level Range	5-5	5. Check Sweep Linearity 5-12
2. Check Delayed Triggering Level Range	5-6	5a. Check Sweep Length 5-12
3. Check Low-Frequency Triggering	5-6	6. Check VARIABLE Time/Division Range 5-12
4. Check AC LF Reject Operation	5-7	7. Check Differential Delay Time Accuracy 5-13
5. Check 20 MHz Triggering	5-7	8. Check Fast Delay Time Accuracy 5-14
6. Check 500 MHz Triggering	5-8	9. Check Delay Jitter 5-14
7. Check HF Sync Triggering	5-9	
8. Check Line Triggering	5-9	
9. Check Single Sweep Operation	5-9	
B. Horizontal System		
1. Set Basic Sweep Calibration	5-10	
2. Check Trace Separation Range (SN B059999-below)	5-10	
3. Check Trace Separation Range and ALT OFF Function (SN B060000-above)	5-10	
4. Check Sweep Timing	5-10	

PRELIMINARY PROCEDURE

1. Install the amplifier plug-in unit in a vertical compartment of the oscilloscope.
2. Install the 7B92A into the horizontal compartment of the oscilloscope.
3. Set the oscilloscope vertical mode switch to display the vertical unit and the horizontal mode switch to display the horizontal unit.
4. Set the oscilloscope intensity controls fully counterclockwise and set the trigger source switches to vertical mode.
5. Turn on the oscilloscope and allow at least 20 minutes warm up before beginning the procedure.

A. TRIGGER SENSITIVITY

Equipment Required

- | | |
|--|--------------------------------------|
| 1. Oscilloscope | 5. Low-frequency sine-wave generator |
| 2. Wide-band vertical amplifier plug-in unit | 6. Time-mark generator |
| 3. High-frequency signal generator | 7. Tee connector, bnc |
| 4. Medium-frequency signal generator | 8. 50 Ω cables (2) |

Control Settings

Set the 7B92A controls as follows:

MAIN TRIGGERING

SLOPE	+
LEVEL	Midrange
MODE	AUTO
COUPLING	AC
SOURCE	INT

Sweep Controls

POSITION	Midrange
TIME/DIV OR DLY TIME	20 μ s
DLY'D Time/Division	10 μ s/PULL FOR ALT
VARIABLE (CAL IN)	In
DELAY TIME MULT	1.0
TRACE SEP	Clockwise
INTENSITY	As desired
CONTRAST	As desired

Delayed Triggering

LEVEL	RUNS AFTER DELAY TIME
SLOPE	+
COUPLING	AC
SOURCE	INT

Inputs

TERM	1 M Ω (in)
------	-------------------

A1. Check Main Triggering Level Range

a. Set the vertical amplifier plug-in unit controls as follows:

Position	midrange
Polarity	+ Up
Input Coupling	dc
Volts/Division	1 V

b. Connect the bnc tee connector to the input of the vertical amplifier plug-in unit.

c. Connect a 50- Ω cable from the low-frequency sine-wave generator to the tee connector.

d. Connect a 50- Ω cable from the tee connector to the MAIN TRIG IN connector.

e. Set the oscilloscope intensity and focus controls for the desired display.

f. Set the low-frequency sine-wave generator for an eight-division display at 50 kHz. Center the display vertically on the graticule.

g. Check—that all levels of the positive slope may be selected for the sweep starting point as the MAIN TRIGGERING LEVEL control is rotated throughout its range, and that triggering occurs at least 3.5 divisions above and below the center horizontal graticule line. See Fig. 5-1 for reference.

h. Check—set the MAIN TRIGGERING SLOPE to — and repeat part g for the negative slope of the waveform.

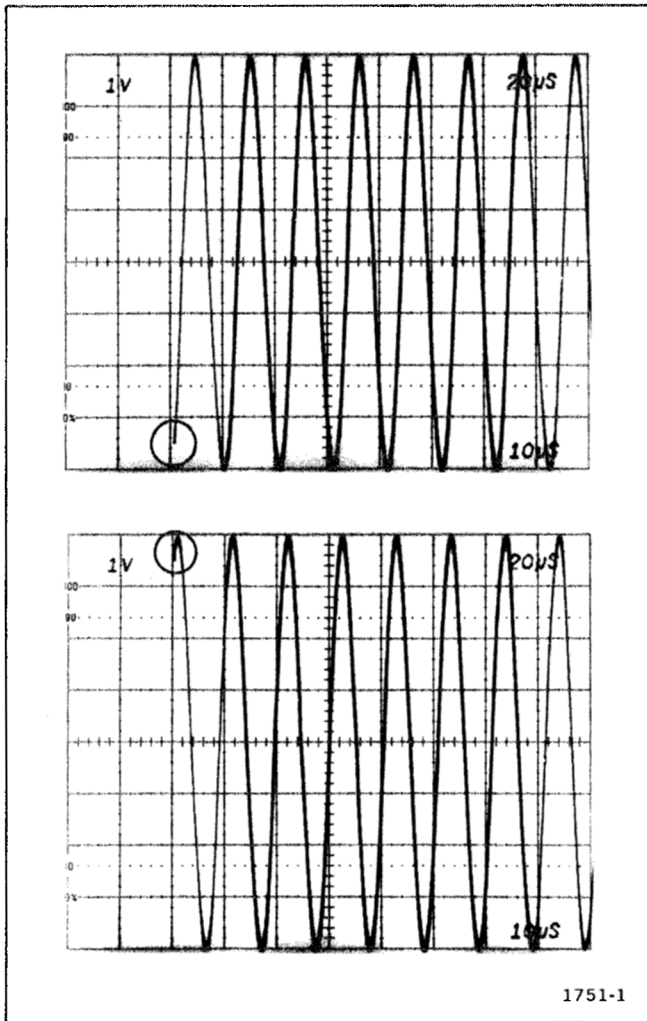

Fig. 5-1. Main Triggering level range.

throughout its range, and that triggering occurs at least 3.5 divisions above and below the center horizontal graticule line. See Fig. 5-2 for reference.

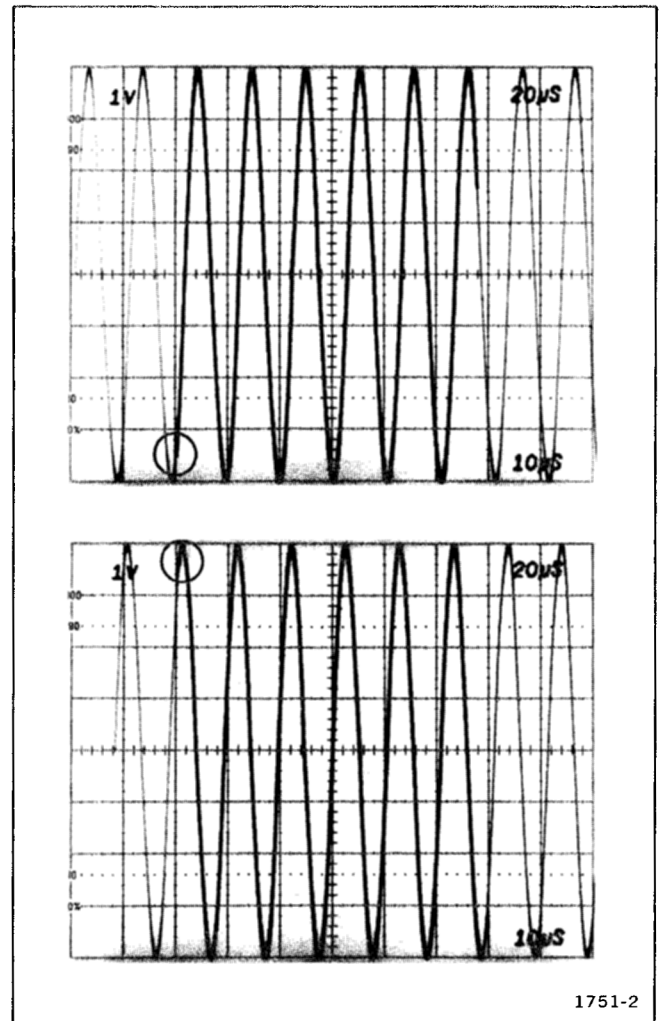

Fig. 5-2. Delayed Triggering level range.

i. Check—set the MAIN TRIGGERING SOURCE to EXT and repeat part g of this step.

j. Check—set the MAIN TRIGGERING SLOPE to + and repeat part g for the positive slope of the waveform.

A2. Check Delayed Triggering Level Range

a. Disconnect the 50-Ω cable from the MAIN TRIG IN connector and reconnect it to the DLY'D TRIG IN connector.

b. Set the Delayed Triggering SOURCE and MAIN TRIGGERING SOURCE to INT.

c. Check—that all levels of the positive slope of the intensified zone may be selected for the sweep starting point as the Delayed Triggering LEVEL control is rotated

d. Check—set the Delayed Triggering SLOPE to – and repeat part c for the negative slope of the waveform.

e. Check—set the Delayed Triggering SOURCE to EXT and repeat part c of this step.

f. Check—set the Delayed Triggering SLOPE to + and repeat part c for the positive slope of the waveform.

A3. Check Low-Frequency Triggering

a. Disconnect the 50-Ω cable from the DLY'D TRIG IN connector and reconnect it to the MAIN TRIG IN connector.

b. Set the 7B92A controls as follows:

MAIN TRIGGERING COUPLING	AC
Delayed Triggering SLOPE	+
Delayed Triggering COUPLING	AC
Delayed Triggering SOURCE	INT
Delayed Triggering LEVEL	RUNS AFTER DELAY TIME
TIME/DIV OR DLY TIME	10 ms
DLY'D Time/Division	2 ms/PULL FOR ALT
DELAY TIME MULT dial	1.0

c. Set the vertical amplifier plug-in unit volts/division switch to 0.2 V.

d. Set the low-frequency sine-wave generator for a 0.5 division (100 mV) display at 30 Hz.

e. Check—for stable display (TRIG'D light on) at all settings of the LEVEL control with MAIN TRIGGERING COUPLING set to:

- (1.) AC
- (2.) AC HF REJ
- (3.) DC

(Set the MAIN TRIGGERING LEVEL control as necessary.)

f. Check—set the MAIN TRIGGERING SOURCE to EXT and repeat part e of this step.

g. Disconnect the 50-Ω cable from the MAIN TRIG IN connector and reconnect it to the DLY'D TRIG IN connector.

h. Set the control settings as follows:

MAIN TRIGGERING SOURCE	INT
Delayed Triggering LEVEL	near "0"
Delayed Triggering SOURCE	EXT

i. Check—for stable display (TRIG'D light on) at all settings of LEVEL controls with Delayed Triggering COUPLING set to:

- (1.) AC
- (2.) DC

(Set the MAIN and Delayed Triggering LEVEL controls as necessary.)

j. Check—set the Delayed Triggering SOURCE to INT and repeat part i of this step.

A4. Check AC LF Reject Operation

a. Disconnect the 50-Ω cable from the DLY'D TRIG IN connector and reconnect it to the MAIN TRIG IN connector.

b. Set the vertical amplifier plug-in unit volts/division switch to 0.5 V.

c. Set the low-frequency sine-wave generator for an eight-division display at 60 Hz. Center the display vertically on the graticule.

d. Check—set the MAIN TRIGGERING LEVEL control for a stable display (TRIG'D light on).

e. Set the MAIN TRIGGERING COUPLING to AC LF REJ; set the MODE to NORM.

f. Check—for no display (TRIG'D light off) when the MAIN TRIGGERING LEVEL control is rotated throughout its range.

g. Set the MAIN TRIGGERING COUPLING to AC; set the SOURCE to EXT.

h. Reduce the output of the low-frequency sine-wave generator to provide a six-division display (3.0 V) at 60 Hz. (Adjust the MAIN TRIGGERING LEVEL control to maintain a stable display.)

i. Set the MAIN TRIGGERING COUPLING to AC LF REJ and repeat part f of this step.

A5. Check 20 MHz Triggering

a. Set the vertical amplifier plug-in unit volts/division switch to 0.2 V.

b. Set the 7B92A controls as follows:

MAIN TRIGGERING COUPLING	AC
MAIN TRIGGERING MODE	AUTO
MAIN TRIGGERING SOURCE	INT

Performance Check/Calibration-7B92A

Delayed Triggering COUPLING, SOURCE and SLOPE	All pushbuttons in
Delayed Triggering LEVEL	RUNS AFTER DELAY TIME
TIME/DIV OR DLY TIME	50 ns
DLY'D Time/Division	5 ns/PULL FOR ALT

c. Disconnect the 50- Ω cable from the low-frequency sine-wave generator and connect the medium-frequency signal generator to the vertical amplifier plug-in unit input using the 50- Ω cable.

d. Set the medium-frequency signal generator for a 0.5 division display (100 mV) at 20 MHz.

e. Check—for a stable display (TRIG'D light on) with the MAIN TRIGGERING COUPLING switch set to:

- (1.) AC
- (2.) AC LF REJ
- (3.) DC

(Set the MAIN TRIGGERING LEVEL control as necessary.)

f. Check—change the MAIN TRIGGERING SOURCE to EXT and repeat part e of this step.

g. Disconnect the 50- Ω cable from the MAIN TRIG IN connector and reconnect it to the DLY'D TRIG IN connector.

h. Set the Delayed Triggering LEVEL control near "0".

i. Set the MAIN TRIGGERING SOURCE to INT and MAIN TRIGGERING COUPLING to AC.

j. Check—for a stable display (TRIG'D light on) with the Delayed Triggering COUPLING set to:

- (1.) AC
- (2.) DC

k. Set the Delayed Triggering SOURCE to EXT and repeat part j of this step.

l. Disconnect the 50- Ω cable from the medium-frequency signal generator; disconnect the 50- Ω cable from the bnc tee at the vertical amplifier plug-in input connector.

A6. Check 500 MHz Triggering

a. Connect the high-frequency leveled sine-wave generator to the bnc tee connected to the vertical amplifier plug-in unit input.

b. Disconnect the 50- Ω cable from the DLY'D TRIG IN connector and reconnect it to the MAIN TRIG IN connector.

c. Set the 7B92A controls as follows:

MAIN TRIGGERING COUPLING	DC
MAIN TRIGGERING SOURCE	EXT
TIME/DIV OR DLY TIME	1 ns
DLY'D Time/Division	1 ns (knob in)

d. Adjust the oscilloscope intensity control for normal viewing.

e. Set the vertical amplifier plug-in unit volts/division switch to 0.5 V.

f. Set the high-frequency leveled sine-wave generator for a one-division display at 500 MHz. Center the display vertically on the graticule.

g. Set the MAIN TRIGGERING LEVEL control for a stable display (TRIG'D light on).

h. Check—for a stable display with no more than 0.05 division of jitter.

i. Check—change the MAIN TRIGGERING SOURCE to INT and repeat parts g and h of this step.

j. Disconnect the 50- Ω cable from the MAIN TRIG IN connector and reconnect it to the DLY'D TRIG IN connector.

k. Set the DLY'D Time/Division to PULL FOR ALT; set the Delayed Triggering SOURCE to EXT.

l. Set the Delayed Triggering LEVEL control for a stable display (near "0").

m. Check—for a stable display with no more than 0.05 division of jitter.

n. Check—change Delayed Triggering SOURCE to INT and repeat m of this step.

A7. Check HF Sync Triggering

a. Disconnect the 50-Ω cable from the DLY'D TRIG IN connector and reconnect it to the MAIN TRIG IN connector.

b. Set the Delayed Triggering LEVEL control to RUNS AFTER DELAY TIME.

c. Set the DLY'D Time/Division switch to Normal mode (knob in).

d. Set the MAIN TRIGGERING MODE to HF SYNC.

e. Set the vertical amplifier plug-in unit volts/division switch to 1 V.

f. Set the MAIN TRIGGERING LEVEL control for a stable display (TRIG'D light on).

g. Check—for a stable display with no more than 0.05 division of jitter.

h. Set the high-frequency leveled sine-wave generator for a one-division display.

i. Check—change the MAIN TRIGGERING SOURCE to EXT ÷ 10 and repeat part g of this step.

j. Disconnect the 50-Ω cable from the high-frequency leveled sine-wave generator.

A8. Check Line Triggering

a. Disconnect the 50-Ω cable from the MAIN TRIG IN connector.

b. Set the MAIN TRIGGERING MODE to AUTO, SOURCE to LINE, and COUPLING to AC; the TIME/DIV OR DLY TIME switch to 1 ms; and DLY'D Time/Division to 1 ms (knob in).

c. Check—set the MAIN TRIGGERING LEVEL control near "0" and check that the TRIG'D light is on.

d. Check—that the display is not triggered (TRIG'D light off) at either end of the MAIN TRIGGERING LEVEL control rotation.

A9. Check Single Sweep Operation

a. Connect the time-mark generator to the input of the vertical amplifier plug-in unit, using a 50-Ω cable; set the generator for 1 ms markers.

b. Set the vertical amplifier plug-in unit deflection factor for approximately two divisions of display; and adjust MAIN TRIGGERING LEVEL control for a stable display.

c. Set the MAIN TRIGGERING SOURCE to INT, MODE to SINGLE SWEEP, and SOURCE to EXT.

d. Press the SINGLE SWEEP RESET pushbutton; it should be lit.

e. Check—change the MAIN TRIGGERING SOURCE to INT and observe that only one sweep is displayed and SINGLE SWEEP RESET pushbutton goes out.

f. Set the TIME/DIV OR DLY TIME switch to Alternate mode (PULL FOR ALT).

g. Set the MAIN TRIGGERING SOURCE to EXT; press the SINGLE SWEEP RESET pushbutton. The pushbutton should be lit.

h. Check—change the MAIN TRIGGERING SOURCE to INT and observe that only one sweep is displayed and SINGLE SWEEP RESET pushbutton goes out.

i. Press SINGLE SWEEP RESET pushbutton several times and observe that display alternates between Delaying and Delayed sweeps.

B. HORIZONTAL SYSTEM

Equipment Required

- | | |
|--|------------------------|
| 1. Oscilloscope | 3. Time-mark generator |
| 2. Wide-band vertical amplifier plug-in unit | 4. 50-Ω cable |

B1. Set Basic Sweep Calibration

- a. Set the 7B92A controls as follows:

MAIN TRIGGERING

SLOPE	+
LEVEL	Midrange
MODE	NORM
COUPLING	AC
SOURCE	INT

Sweep Controls

POSITION	Midrange
TIME/DIV OR DLY TIME	1 ms
DLY'D Time/Division	1 ms (knob in)

Delayed Triggering

LEVEL	RUNS AFTER DELAY TIME
-------	--------------------------

b. Connect the time-mark generator to the vertical amplifier plug-in unit input with a 50-Ω cable. Set the time-mark generator for 1 ms markers.

c. Set the oscilloscope intensity and focus controls for a desired display.

d. Set the vertical amplifier plug-in unit for approximately two divisions of display. Position the display in the center graticule area. Set the MAIN TRIGGERING LEVEL control for a stable display (TRIG'D light on).

e. Set the front panel SWP CAL adjustment for one marker/division over the center eight divisions (position as necessary).

B2. Check Trace Separation Range (SN B059999- below)

- a. Set the 7B92A controls as follows:

TIME/DIV OR DLY TIME	1 ms
DLY'D Time/Division	0.2 ms/PULL FOR ALT
TRACE SEP	Fully clockwise

b. Check—for Delaying sweep (with intensified zone) positioned at least 3.5 divisions above Delayed sweep.

B3. Check Trace Separation Range and Alt Off Function (SN B060000-above)

a. Check—for Delaying sweep (with intensified zone) positioned at least 3.5 divisions above Delayed sweep.

b. Set the TRACE SEP control fully counterclockwise (ALT OFF).

c. Check—for an intensified portion on the Delaying sweep, and that the gate (checked at oscilloscope Gate Out connector) is divided by two.

d. Set the TRACE SEP control clockwise.

B4. Check Sweep Timing

NOTE

The tolerances given in Table 5-2 are for ambient temperature range of +15°C to +35°C. If outside this range, see the Specification section for applicable tolerances.

a. Set the TIME/DIV OR DLY TIME, DLY'D Time/Division in Alternate mode (PULL FOR ALT), and time-mark generator as indicated in Table 5-2; set DELAY TIME MULT dial to 0.0.

Table 5-2
SWEEP TIMING

TIME/DIV OR DLY TIME	DLY'D Time/Division	Time-Mark Generator Setting	Tolerance (+15°C to +35°C)	
			Delaying Sweep	Delayed Sweep
0.2 s	0.2 s	0.2 s	Within 0.16 div	Within 0.16 div
0.1 s	0.1 s	0.1 s	Within 0.16 div	Within 0.16 div
50 ms	50 ms	50 ms	Within 0.16 div	Within 0.16 div
20 ms	20 ms	20 ms	Within 0.16 div	Within 0.16 div
10 ms	10 ms	10 ms	Within 0.16 div	Within 0.16 div
5 ms	5 ms	5 ms	Within 0.16 div	Within 0.16 div
2 ms	2 ms	2 ms	Within 0.16 div	Within 0.16 div
1 ms	1 ms	1 ms	Within 0.16 div	Within 0.16 div
0.5 ms	0.5 ms	0.5 ms	Within 0.16 div	Within 0.16 div
0.2 ms	0.2 ms	0.2 ms	Within 0.16 div	Within 0.16 div
0.1 ms	0.1 ms	0.1 ms	Within 0.16 div	Within 0.16 div
50 μs	50 μs	50 μs	Within 0.16 div	Within 0.16 div
20 μs	20 μs	20 μs	Within 0.16 div	Within 0.16 div
10 μs	10 μs	10 μs	Within 0.16 div	Within 0.16 div
5 μs	5 μs	5 μs	Within 0.16 div	Within 0.16 div
2 μs	2 μs	2 μs	Within 0.16 div	Within 0.16 div
1 μs	1 μs	1 μs	Within 0.16 div	Within 0.16 div
0.5 μs	0.5 μs	0.5 μs	Within 0.16 div	Within 0.16 div
0.2 μs	0.2 μs	0.2 μs	Within 0.16 div	Within 0.16 div
0.1 μs	0.1 μs	0.1 μs	Within 0.16 div	Within 0.16 div
50 ns	50 ns	50 ns	Within 0.16 div	Within 0.16 div
20 ns	20 ns	20 ns	Within 0.16 div	Within 0.16 div
10 ns	10 ns	10 ns	Within 0.24 div	Within 0.24 div

b. Check—using the settings given in Table 5-2, check sweep accuracy for one time mark/division over the center eight divisions within the tolerance given in Table 5-2. Set the POSITION control and MAIN TRIGGERING LEVEL control as necessary for a stable display that is aligned with the vertical graticule lines.

NOTE

If the time-mark generator used does not have 1-2-5 sequence markers, apply 1 unit markers in place of 2 unit markers and check for 2 markers/division over the center eight divisions of display, to the tolerances given in Table 5-2.

c. Push in the DLY'D Time/Division knob and position the display to the center of the graticule.

d. Check—using the settings given in Table 5-3, check sweep accuracy over the center eight divisions within the tolerance given in Table 5-3.

NOTE

The HF SYNC MODE switch may provide a better display when checking the fastest sweep rates.

Table 5-3

FAST TIMING

TIME/DIV OR DLY TIME	Time-mark Generator Setting	Display Markers/Division	Tolerance (+15°C to +35°C)
5 ns	5 ns	1	Within 0.24 div
2 ns	2 ns	1	Within 0.32 div
1 ns	1 ns	1	Within 0.32 div
0.5 ns	1 ns	1 cycle/2 div	Within 0.40 div

B5. Check Sweep Linearity

a. Set the TIME/DIV OR DLY TIME and DLY'D Time/Division switch to 1 ms and pull DLY'D Time/Division knob out for Alternate mode.

b. Set the time-mark generator for 1 ms markers.

c. Position the Delaying (top) and Delayed-sweep traces horizontally to start on the first graticule line.

d. Check—that the fourth marker of the Delaying sweep coincides within 0.1 division with the fourth vertical graticule line.

e. Check—continue linearity check, as in part d of this step, for each successive two divisions of the Delaying sweep.

f. Check—repeat parts d and e of this step to check linearity of the Delayed (bottom) sweep.

g. Set the TIME/DIV OR DLY TIME and DLY'D Time/Division switch to 10 ns and pull DLY'D Time/Division knob out for Alternate mode.

h. Set the time-mark generator for 10 ns markers.

i. Check—perform linearity check as in parts d, e, and f of this step. Tolerance is 0.1 division for each two divisions over center eight graticule divisions.

j. Set the DLY'D Time/Division to Normal mode (knob in).

k. Check—continue linearity check for Delayed sweep rates as shown in Table 5-4.

B5a. Check Sweep Length

a. Set the time-mark generator for 1 ms markers.

b. Set the TIME/DIV OR DLY TIME and DLY'D Time/Division switch to 1 ms, and pull DLY'D Time/Division knob out for alternate.

c. Check—both Delaying and Delayed sweeps are typically greater than 10.2 divisions.

Table 5-4

FAST SWEEP LINEARITY

Time/Division	Time-mark Generator Setting	Markers/2 Divisions	Tolerance/2 Divisions
5 ns	5 ns	2	0.2 div
2 ns	2 ns	2	0.2 div
1 ns	1 ns	2	0.2 div
0.5 ns	1 ns	1	0.2 div

B6. Check Variable Time/Division Range

a. Remove the 7B92A from the oscilloscope plug-in compartment.

b. Place the Time/Division Variable Selector multi-pin connector on P761 (Delaying Sweep). See Fig. 1-1 for location.

c. Insert the 7B92A into the oscilloscope plug-in compartment; turn on the power to the oscilloscope.

d. Set the time-mark generator for 100 μs markers.

e. Set the TIME/DIV OR DLY TIME and DLY'D Time/Division switch to 20 μs and pull DLY'D Time/Division knob out for Alternate mode. Check that the DELAY TIME MULT dial is 0.0.

Performance Check/Calibration-7B92A

f. Press and release VARIABLE control and turn it fully counterclockwise.

g. Check—that Delaying sweep markers (top) and Delayed sweep markers are displayed as shown in Fig. 5-3a; at least 2-1/2 Delaying sweep markers to one Delayed sweep marker are visible.

h. Remove the 7B92A from the oscilloscope plug-in compartment; reposition the Time/Division Variable Selector multi-pin connector to P760 and re-install the 7B92A into the plug-in compartment. Turn on power to the oscilloscope.

i. Check—with VARIABLE control released and turned fully counterclockwise, at two Delayed sweep markers (bottom) to one Delaying sweepmarker is visible, as shown in Fig. 5-3b.

NOTE

With the Time/Division Variable Selector Multi-Pin connector positioned to P760 the VARIABLE control shortens the sweep to accomplish it's purpose.

B7. Check Differential Delay Time Accuracy

a. Set the TIME/DIV OR DLY TIME switch to 200 ms, DLY'D Time/Division switch (pull knob out) to 5 ms (then

push knob in), push in VARIABLE (CAL IN) control, and adjust MAIN TRIGGERING LEVEL control for a stable display (TRIG'D light on).

b. Set the time-mark generator for 100 ms markers.

c. Set the vertical amplifier plug-in unit deflection factor for approximately two divisions of display.

d. Set the DELAY TIME MULT dial to 0.90.

e. Align the time-mark to the center vertical graticule line, using the POSITION control.

f. Turn the DELAY TIME MULT dial to approximately 8.9 to align the time-mark to the center vertical graticule line.

g. Check—the DLY TIME MULT dial to read within three minor divisions of 8.90 (8.87 to 8.93).

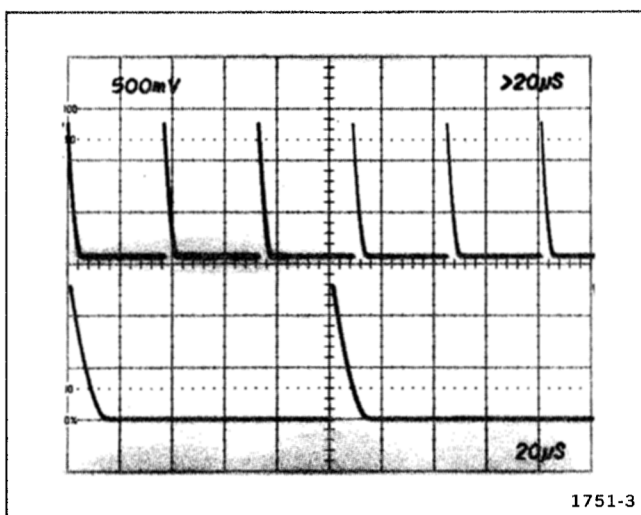

Fig. 5-3a. Variable Time/Division range.

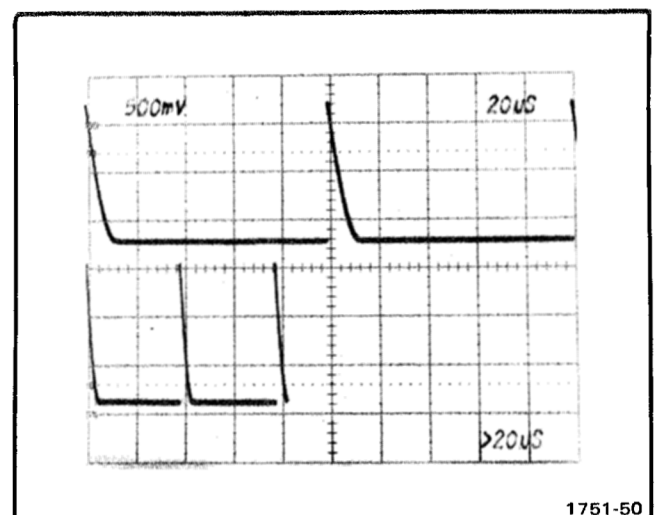

Fig. 5-3b. Variable Time/Division range.

Performance Check/Calibration-7B92A

h. Repeat parts d through g of this step for each sweep rate given in Table 5-5. Maintain approximately two divisions of display.

Table 5-5

DIFFERENTIAL DELAY TIME ACCURACY

TIME/DIV OR DLY TIME	DLY'D Time/Division	Time-mark Generator Setting
.2 s	5 ms	0.1 s
.1 s	2 ms	50 ms
50 ms	1 ms	10 ms
20 ms	0.5 ms	10 ms
10 ms	0.2 ms	5 ms
5 ms	0.1 ms	1 ms
2 ms	50 μ s	1 ms
1 ms	20 μ s	0.5 ms
.5 ms	10 μ s	0.1 ms
.2 ms	5 μ s	0.1 ms
.1 ms	2 μ s	50 μ s
50 μ s	1 μ s	10 μ s
20 μ s	.5 μ s	10 μ s
10 μ s	.2 μ s	5 μ s
5 μ s	.1 μ s	1 μ s
2 μ s	50 ns	1 μ s
1 μ s	20 ns	0.5 μ s
.5 μ s	10 ns	0.1 μ s
.2 μ s	5 ns	50 ns
.1 μ s	5 ns	50 ns

B8. Check Fast Delay Time Accuracy

a. Set the TIME/DIV OR DLY TIME switch to 50 ns, DLY'D Time/Division switch (pull knob out) to 10 ns (then push knob in), and adjust the MAIN TRIGGERING LEVEL control for a stable display (TRIG'D light on).

b. Set the time-mark generator for 50 ns markers.

c. Set the vertical amplifier plug-in unit deflection factor for approximately two divisions of display.

d. Set the DELAY TIME MULT dial to 9.00.

e. Align the leading edge of the time-mark to the center vertical graticule line, using the POSITION control. See Fig. 5-4 for reference.

f. Check—set the DELAY TIME MULT dial to the settings listed in Table 5-6, and check for maximum error in dial reading.

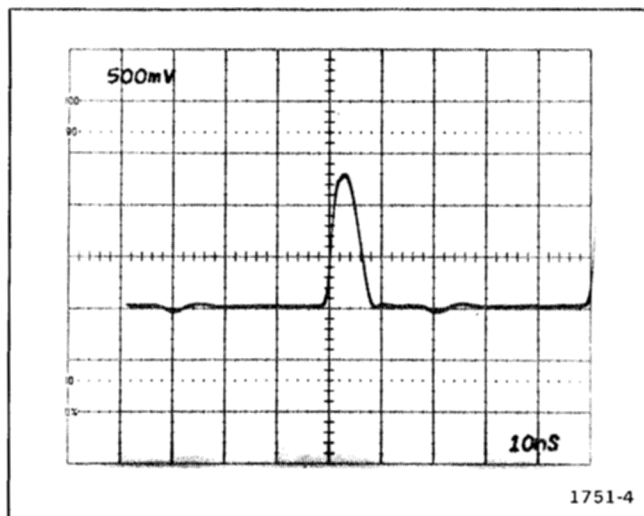

Fig. 5-4. Fast delay time accuracy.

Table 5-6

FAST DIFFERENTIAL DELAY TIME ACCURACY

DELAY TIME MULT	Maximum Error (Minor Dial Divisions)
9.0	0 (step e)
8.0	Within 3.0
7.0	Within 3.5
6.0	Within 4.0
5.0	Within 4.5
4.0	Within 5.0
3.0	Within 3.0
2.0	Within 6.0
1.0	Within 6.5

g. Set the TIME/DIV OR DLY TIME switch to 20 ns, DLY'D Time/Division switch (pull knob out) to 2 ns (then push knob in), and adjust the MAIN TRIGGERING LEVEL control for a stable display (TRIG'D light on).

h. Set the time-mark generator for 20 ns markers.

i. Repeat parts d, e, and f of this step.

j. Set the TIME/DIV OR DLY TIME switch to 10 ns, DLY'D Time/Division switch (pull knob out) to 1 ns (then push knob in), and adjust the MAIN TRIGGERING LEVEL control for a stable display (TRIG'D light on).

k. Set the time-mark generator for 10 ns markers.

l. Repeat parts d, e, and f of this step. Delete check at DELAY TIME MULT dial setting of 1.0.

B9. Check Delay Jitter

a. Set the TIME/DIV OR DLY TIME switch to 1 ms, DLY'D Time/Division switch (pull knob out) to 5 μ s then push knob in), and adjust the MAIN TRIGGERING LEVEL control for a stable display (TRIG'D light on).

b. Set the time-mark generator for 1 ms markers.

c. Set the DELAY TIME MULT dial to approximately 1.0 (position the time-mark to the center of the graticule).

d. Set the DLY'D Time/Division switch to 0.2 μ s.

e. Turn the DELAY TIME MULT dial slowly to position the time-mark near the graticule center (turn un INTENSITY control as necessary).

f. Check—jitter must not exceed one division (disregard slow drift).

g. Set the TIME/DIV OR DLY TIME switch to 20 μ s, DLY'D Time/Division switch (pull knob out) to 50 ns (then push knob in), and adjust the MAIN TRIGGERING LEVEL control for a stable display (TRIG'D light on).

h. Set the time-mark generator for 1 μ s markers.

i. Set the DLY'D Time/Division switch to 5 ns.

j. Turn the DELAY TIME MULT dial slowly to position the time-mark near the graticule center (turn up INTENSITY control as necessary).

k. Check—jitter must not exceed 0.9 division.

l. Turn the DELAY TIME MULT dial to approximately 9.0 and position the time-mark to the center of the graticule.

m. Check—jitter must not exceed 0.8 division.

This completes the Performance Check procedure of the 7B92A.

PART II—CALIBRATION

The following procedure returns the 7B92A to correct calibration. All limits and tolerances given in this procedure are calibration guides and should not be interpreted as instrument specifications except as specified in the Specification section of this manual. Where possible, instrument performance is checked before an adjustment is made. When performing a complete Calibration procedure, make each adjustment to the given setting, even if the Check— is within the allowable tolerance.

OUTLINE FOR PART II—CALIBRATION

		Page
A. Trigger Sensitivity (SN B070000-above)		
1. Preliminary Main Triggering Adjustment	5-18	
2. Adjust Main Triggering Internal DC Balance	5-18	
3. Adjust Main Triggering Sensitivity	5-19	
4. Adjust External DC Balance	5-19	
5. Check Main Triggering Level Range	5-19	
6. Preliminary Delayed Triggering Adjustment	5-20	
7. Adjust Delayed Triggering Sensitivity	5-20	
8. Adjust Delayed Triggering External DC Balance	5-20	
9. Check Delayed Triggering Level Range	5-20	
10. Check Low-Frequency Triggering	5-21	
11. Check AC LF Reject Operation	5-22	
12. Check 20 MHz Triggering	5-22	
13. Check 500 MHz Triggering	5-23	
14. Check HF Sync Triggering	5-23	
15. Check Line Triggering	5-23	
16. Check Single Sweep Operation	5-24	
B. Trigger Sensitivity (SN B069999-below)		
1. Preliminary Main Triggering Adjustment	5-25	
2. Adjust Main Triggering Arming Tunnel Diode Bias		5-26
3. Adjust Main Triggering Gate Tunnel Diode Bias		5-26
4. Adjust Main Triggering Internal DC Balance		5-26
5. Adjust Main Triggering Sensitivity		5-26
6. Adjust Main Triggering External DC Balance		5-26
7. Check Main Triggering Level Range		5-26
8. Preliminary Delayed Triggering Adjustment		5-27
9. Adjust Delayed Triggering Arming Tunnel Diode Bias		5-28
10. Adjust Delayed Triggering Gate Tunnel Diode Bias		5-28
11. Adjust Delayed Triggering Internal DC Balance		5-28
12. Adjust Delayed Triggering Sensitivity		5-28
13. Adjust Delayed Triggering External DC Balance		5-28
14. Check Delayed Triggering Level Range		5-28
15. Check Low-Frequency Triggering		5-28
16. Check AC LF Reject Operation		5-29
17. Check 20 MHz Triggering		5-30
18. Check 500 MHz Triggering		5-30
19. Check HF Sync Triggering		5-31
20. Check Line Triggering		5-31
21. Check Single Sweep Operation		5-31

C. Horizontal System	Page		Page
1. Set Basic Sweep Calibration	5-33	15. Check Variable Time/Division Range	5-38
2. Check Trace Separation Range (SN B059999-below)	5-33	16. Check Differential Delay Time Accuracy	5-38
3. Check Trace Separation Range and Alt Off Function (SN B060000-above)	5-33	17. Check Fast Delay Time Accuracy	5-39
4. Adjust DTM Scale and Delay Start	5-33	18. Check Delay Jitter	5-40
5. Adjust Delaying Sweep Calibration	5-34		
6. Adjust Sweep Registration	5-34		
7. Adjust Position Centering	5-34		
8. Check Sweep Length	5-34		
9. Adjust 2 ns Timing	5-34		
10. Adjust Delayed Sweep 20 ns Timing	5-35		
11. Adjust Delaying Sweep 20 ns Timing	5-35		
12. Adjust Time Position	5-35		
13. Check Sweep Timing	5-36		
14. Check Sweep Linearity	5-37		

PRELIMINARY PROCEDURE

1. Install the amplifier plug-in unit in a vertical compartment of the oscilloscope.
2. Install the 7B92A into a plug-in extender; install the extender into the horizontal compartment of the oscilloscope.
3. Set the oscilloscope vertical mode switch to display the vertical unit and the horizontal mode switch to display the horizontal unit.
4. Set the oscilloscope intensity controls fully counterclockwise, and set the trigger source switches to vertical mode.
5. Turn on the oscilloscope and allow at least 20 minutes warm up before beginning the procedure.

A. TRIGGER SENSITIVITY (For instruments SN B070000-above)

Equipment Required

- | | |
|--|------------------------|
| 1. Oscilloscope | 6. Time-mark generator |
| 2. Wide-band vertical amplifier plug-in unit | 7. Plug-in extender |
| 3. High-frequency signal generator | 8. Tee connector, bnc |
| 4. Medium-frequency signal generator | 9. 50 Ω cables (2) |
| 5. Low-frequency sine-wave generator | 10. Digital voltmeter |

Control Settings

Set the 7B92A controls as follows:

MAIN TRIGGERING

SLOPE	+
LEVEL	Midrange
MODE	AUTO
COUPLING	AC
SOURCE	INT

Sweep Controls

POSITION	Midrange
TIME/DIV OR DLY TIME	20 μs
DLY'D Time/Division	10 μs/PULL FOR ALT
VARIABLE (CAL IN)	In
DELAY TIME MULT	1.0
TRACE SEP	Clockwise
INTENSITY	Visible Main Sweep
CONTRAST	Visible Intensified Zones

Delayed Triggering

LEVEL	RUNS AFTER DELAY TIME
SLOPE	+
COUPLING	AC
SOURCE	INT

Inputs

TERM	1 MΩ (in)
------	-----------

Vertical Amplifier Plug-In Unit

Position	Midrange
Polarity	+ up
Input Coupling	dc
Volts/Division	50 mV

A1. Preliminary Main Triggering Adjustment

- a. Connect the bnc tee connector to the input of the vertical amplifier plug-in unit.
- b. Connect a 50-Ω cable from the low-frequency sinewave generator to the tee connector.

c. Connect a 50-Ω cable from the tee connector to the MAIN TRIG IN connector.

d. Set the oscilloscope intensity and focus controls for the desired display.

e. Set the low-frequency sine-wave generator for a four-division display at 50 kHz. Center the display vertically on the graticule.

f. Adjust—Int DC Bal, R75, Ext DC BAL, R99, and Trig Sens, R175, to midrange.

g. Connect digital voltmeter to pin 4 of P204. Be sure that Delayed Triggering LEVEL is set to exactly "0".

h. Adjust POT CTR, R254, for a meter reading of zero volts.

i. Disconnect the digital voltmeter.

A2. Adjust Main Triggering Internal DC Balance

- a. Set the MAIN TRIGGERING LEVEL control to "0".
- b. Adjust—Int DC Bal, R75, for a sweep trigger point at graticule centerline (TRIG'D light on). See Fig. 5-5 for reference.

A3. Adjust Main Triggering Sensitivity

Adjust—Trig Sens, R175, so the main sweep untriggers between 0.3 and 0.1 division from bottom of waveform as MAIN TRIGGERING LEVEL control is rotated through negative (–) portion of its range. See Fig. 5-6 for reference.

NOTE

Setting a trigger sensitivity so display is triggered at less than 0.1 division should be avoided to prevent erratic triggering.

- b. Reset the MAIN TRIGGERING LEVEL control to "0".

A4. Adjust External DC Balance

- a. Set the MAIN TRIGGERING SOURCE to EXT.
- b. Adjust—Ext DC Bal, R99, for a sweep trigger point at graticule centerline (TRIG'D light on). See Fig. 5-5 for reference.
- c. Set the MAIN TRIGGERING SOURCE to INT.

A4.5 ADJUST MAIN TRIGGERING AC HF REJ BALANCE

- a. Set the MAIN TRIGGERING LEVEL control to "0".
- b. Set the MAIN TRIGGERING COUPLING to AC HF REJ.

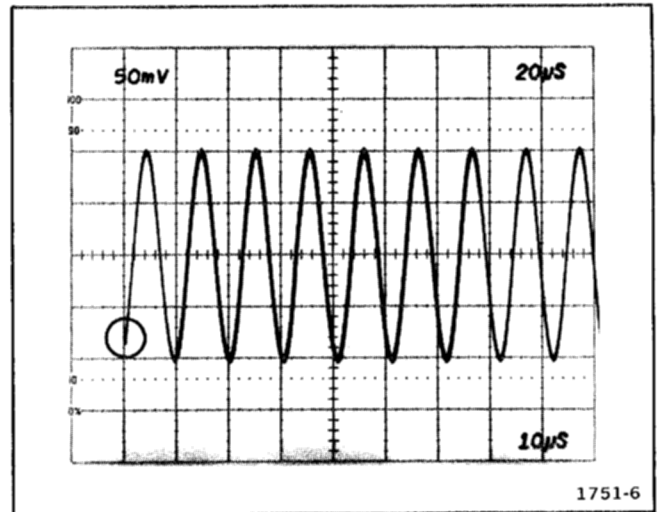

Fig. 5-6. Trigger Sensitivity. (Circle denotes correct trigger point).

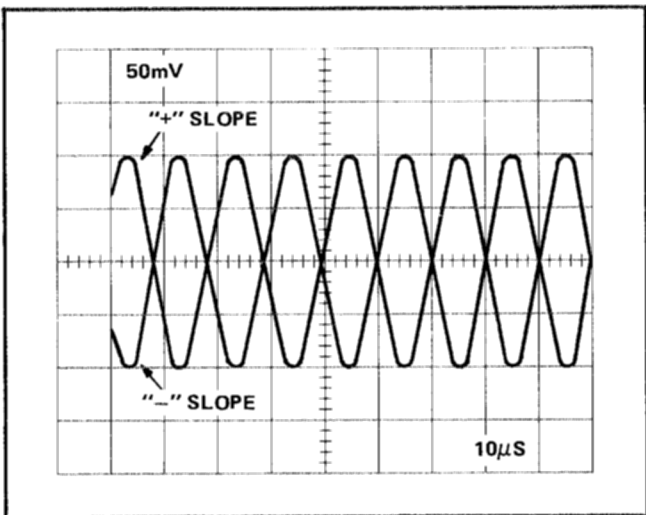

Fig. 5-4A. AC HF REJ Balance.

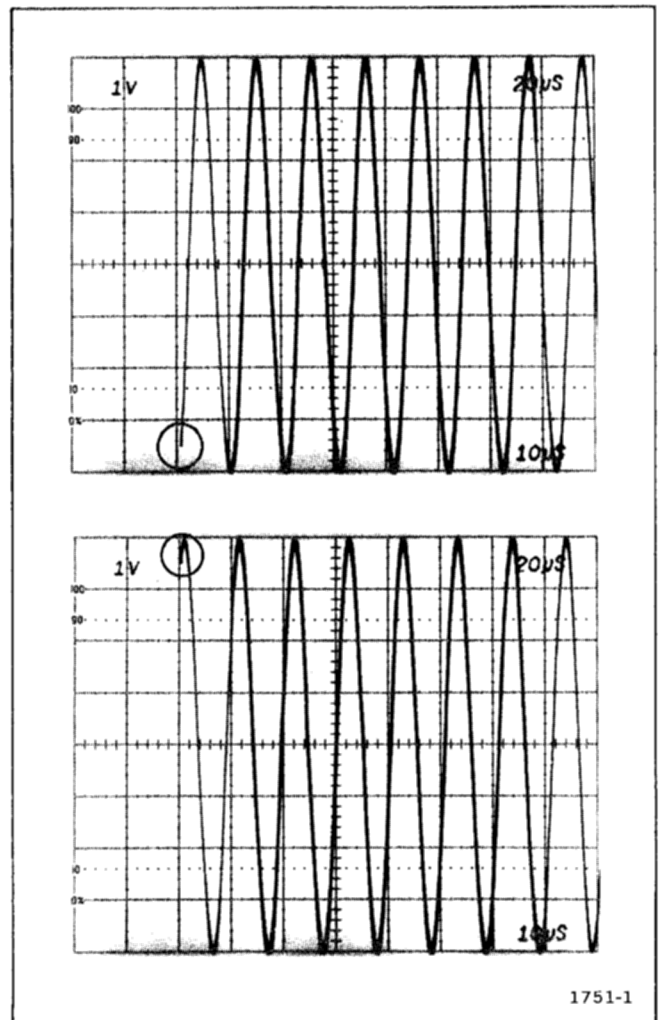

Fig. 5-7. Main Triggering level range. (Circle denotes triggering limits).

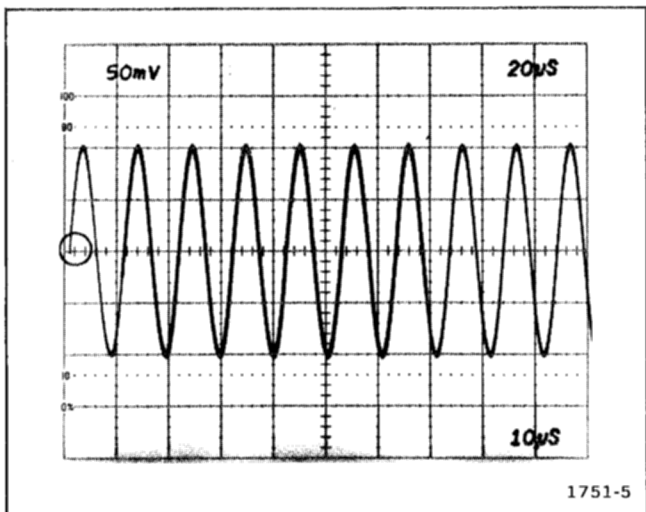

Fig. 5-5. DC balance. (Circle denotes correct trigger point).

Performance Check/Calibration-7B92A

- c. Adjust—AC HG REJ BAL, R90, for a sweep trigger point, one division above center graticule.
- d. Set the MAIN TRIGGERING SLOPE to “—”.
- e. Note the position of the sweep trigger point.
- f. Adjust—AC HF REJ BAL, R90, so that the sweep trigger point is the same distance from the center graticule in both “+”, and “—” MAIN TRIGGERING SLOPE.
- g. Set the MAIN TRIGGERING COUPLING to AC.
- h. Set the MAIN TRIGGERING SLOPE to “+”.

A5. Check Main Triggering Level Range

- a. Set the vertical amplifier plug-in unit volts/division switch to 1 V.
- b. Set the low-frequency sine-wave generator for an eight-division display at 50 kHz. Center the display vertically on the graticule.
- c. Check—that all levels of the positive slope may be selected for the sweep starting point as the MAIN TRIGGERING LEVEL control is rotated throughout its range, and that triggering occurs at least 3.5 divisions above and below the center horizontal graticule line. See Fig. 5-7 for reference.
- d. Check—set the MAIN TRIGGERING SLOPE to — and repeat part c for the negative slope of the waveform.
- e. Check—set the MAIN TRIGGERING SOURCE to EXT and repeat part c of this step.
- f. Check—set the MAIN TRIGGERING SLOPE to + and repeat part c for the positive slope of waveform.

A6. Preliminary Delayed Triggering Adjustment

- a. Disconnect the 50- Ω cable from the MAIN TRIG IN connector and reconnect it to the DLY'D TRIG IN connector.
- b. Set the 7B92A controls as follows:

MAIN TRIGGERING SOURCE	INT
MAIN TRIGGERING LEVEL	Near “0”
Delayed Triggering SLOPE	+
Delayed Triggering COUPLING	AC
Delayed Triggering SOURCE	INT
Delayed Triggering LEVEL	“0”
DELAY TME MULT TIME/DIV OR DELAY TIME	1.0
DLY'D Time/Division	20 μ s
	10 μ s/PULL FOR ALT

- c. Adjust Ext DC Bal, R230, Int DC Bal, R255, and Trig Sens, R320, to midrange.
- d. Set the vertical amplifier plug-in unit volts/division switch to 50 mV.
- e. Set the low-frequency sine-wave generator for a four-division display at 50 kHz. Center the display vertically on the graticule.
- f. Adjust—Int DC Bal, R255, for a sweep trigger point at graticule centerline (TRIG'D light on). See Fig. 5-5 for reference.

A7. Adjust Delayed Triggering Sensitivity

- a. Adjust—Trig Sens, R320, for a sweep trigger point at approximately 0.3 division from bottom of waveform as Delayed Triggering LEVEL control is rotated through negative (—) portion of its range. See Fig. 5-6 for reference.

NOTE

Setting trigger sensitivity so display is triggered at less than 0.1 division should be avoided to prevent erratic triggering.

- b. Reset the Delayed Triggering LEVEL control to “0”.

A8. Adjust Delayed Triggering External DC Balance

- a. Set Delayed Triggering SOURCE to EXT.
- b. Adjust—Ext DC Bal, R230, for a sweep trigger point at graticule centerline (TRIG'D light on). See Fig. 5-5 for reference.
- c. Set the Delayed Triggering SOURCE to INT.

A9. Check Delayed Triggering Level Range

- a. Set the vertical amplifier plug-in unit volts/division switch to 1 V.
- b. Set the low-frequency sine-wave generator for an eight-division display at 50 kHz. Center the display vertically on the graticule. (Lower the Delaying sweep intensity with the oscilloscope intensity control).
- c. Check—that all levels of the positive slope of the intensified zone may be selected for the sweep starting point as the Delayed Triggering LEVEL control is rotated throughout its range, and that triggering occurs at least 3.5 divisions above and below the center horizontal graticule line. See Fig. 5-8 for reference.

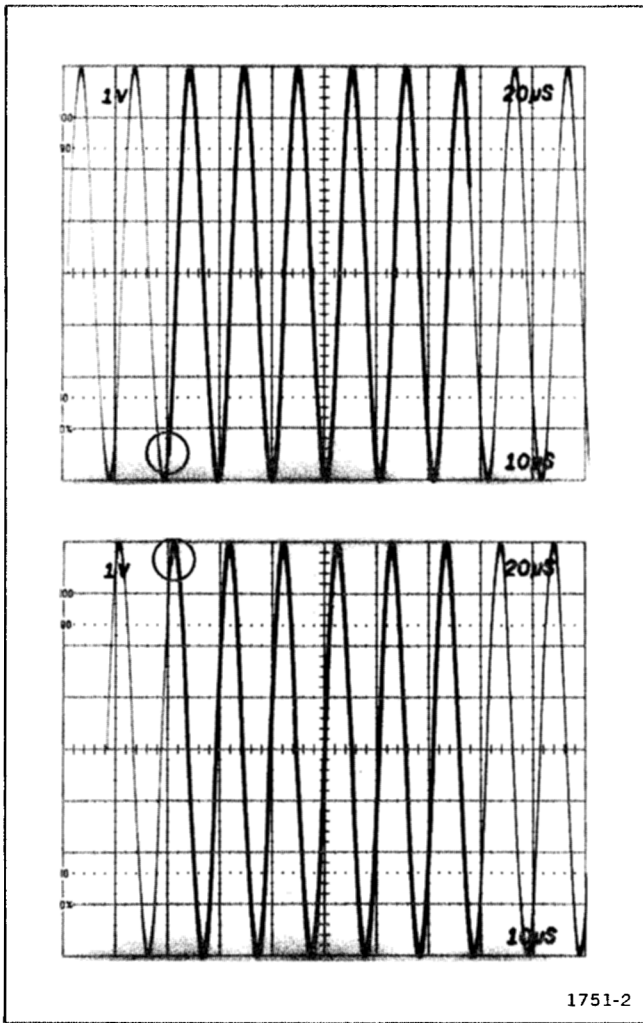

Fig. 5-8. Delayed Triggering level range. (Circle denotes triggering limits.)

d. Check—set the Delayed Triggering SLOPE to — and repeat part c for the negative slope of the waveform.

e. Check—set the Delayed Triggering SOURCE to EXT and repeat part c of this step.

f. Check—set the Delayed Triggering SLOPE to + and repeat part c for the positive slope of the waveform.

A10. Check Low-Frequency Triggering

a. Disconnect the 50-Ω cable from the DLY'D TRIG IN connector and reconnect it to the MAIN TRIG IN connector.

b. Set the 7B92A controls as follows:

MAIN TRIGGERING AC
COUPLING

Delayed Triggering +
SLOPE
Delayed Triggering AC
COUPLING
Delayed Triggering INT
SOURCE
Delayed Triggering RUNS AFTER
LEVEL DELAY TIME
TIME/DIV OR DLY TIME 10 ms
DLY'D Time/Division 2 ms/PULL FOR ALT
DELAY TIME MULT 1.0
TRACE SEP Clockwise

c. Set the vertical amplifier plug-in unit volts/division switch to 0.2 V.

d. Set the low-frequency sine-wave generator for a 0.5 division (100 millivolts) display at 30 Hz.

e. Check—for a stable display (TRIG'D light on) at all settings of the MAIN TRIGGERING LEVEL control with MAIN TRIGGERING COUPLING set to:

- (1.) AC
- (2.) AC HF REJ
- (3.) DC

(Set the MAIN TRIGGERING LEVEL control as necessary.)

f. Check—set the MAIN TRIGGERING SOURCE to EXT and repeat part e of this step.

g. Disconnect the 50-Ω cable from the MAIN TRIG IN connector and reconnect it to the DLY'D TRIG IN connector.

h. Set the control settings as follows:

MAIN TRIGGERING INT
SOURCE
Delayed Triggering near "0"
LEVEL
Delayed Triggering EXT
SOURCE

i. Check—for a stable display (TRIG'D light on) at all settings of LEVEL controls with Delayed Triggering COUPLING set to:

- (1.) AC
- (2.) DC

(Set the MAIN and Delayed Triggering LEVEL controls as necessary.)

Performance Check/Calibration-7B92A

j. Check—set the Delayed Triggering SOURCE to INT and repeat part i of this step.

A11. Check AC LF Reject Operation

a. Disconnect the 50-Ω cable from the DLY'D TRIG IN connector and reconnect it to the MAIN TRIG IN connector.

b. Set the vertical amplifier plug-in unit volts/division switch to 0.5 V.

c. Set the low-frequency sine-wave generator for an eight-division display at 60 Hz. Center the display vertically on the graticule.

d. Check—set the MAIN TRIGGERING LEVEL control for a stable display (TRIG'D light on).

e. Set the MAIN TRIGGERING COUPLING to AC LF REJ; set the MODE to NORM.

f. Check—for no display (TRIG'D light off) when the MAIN TRIGGERING LEVEL control is rotated throughout its range.

g. Set the MAIN TRIGGERING COUPLING to AC; set the SOURCE to EXT.

h. Reduce the output of the low-frequency sine-wave generator to provide a six-division display (3.0 V) at 60 Hz. (Adjust the MAIN TRIGGERING LEVEL control to maintain a stable display.)

i. Set the MAIN TRIGGERING COUPLING to AC LF REJ and repeat part f of this step.

A12. Check 20 MHz Triggering

a. Set the vertical amplifier plug-in unit volts/division switch to 0.2 V.

b. Set the 7B92A controls as follows:

MAIN TRIGGERING COUPLING	AC
MAIN TRIGGERING MODE	AUTO
MAIN TRIGGERING SOURCE	INT

Delayed Triggering COUPLING, SOURCE and SLOPE	All pushbuttons in
---	--------------------

Delayed Triggering LEVEL	RUNS AFTER DELAY TIME
TIME/DIV OR DLY TIME	50 ns
DLY'D Time/Division	5 ns/PULL FOR ALT

c. Disconnect the 50-Ω cable from the low-frequency sine-wave generator and connect the medium-frequency signal generator to the vertical amplifier plug-in unit input using the 50-Ω cable.

d. Set the medium-frequency signal generator for a 0.5 division display (100 mV) at 20 MHz.

e. Check—for a stable display (TRIG'D light on) with the MAIN TRIGGERING COUPLING switch set to:

- (1.) AC
- (2.) AC LF REJ
- (3.) DC

(Set the MAIN TRIGGERING LEVEL control as necessary.)

f. Check—change the MAIN TRIGGERING SOURCE to EXT and repeat part e of this step.

g. Disconnect the 50-Ω cable from the MAIN TRIG IN connector and reconnect it to the DLY'D TRIG IN connector.

h. Set the Delayed Triggering LEVEL control near "0".

i. Set the MAIN TRIGGERING SOURCE to INT and MAIN TRIGGERING COUPLING to AC.

j. Check—for a stable display (TRIG'D light on) with the Delayed Triggering COUPLING switch set to:

- (1.) AC
- (2.) DC

k. Set the Delayed Triggering SOURCE to EXT and repeat part j of this step.

l. Disconnect the 50-Ω cable from the medium-frequency signal generator; disconnect the 50-Ω cable from the bnc tee at the vertical amplifier plug-in input connector.

A13. Check 500 MHz Triggering

a. Connect the high-frequency leveled sine-wave generator to the bnc tee connected to the vertical amplifier plug-in unit input.

b. Disconnect the 50- Ω cable from the DLY'D TRIG IN connector and reconnect it to the MAIN TRIG IN connector.

c. Set the 7B92A controls as follows:

MAIN TRIGGERING	DC
COUPLING	
MAIN TRIGGERING	EXT
SOURCE	
TIME/DIV OR DLY TIME	1 ns
DLY'D Time/Division	1 ns (knob in)

d. Adjust the oscilloscope intensity control for normal viewing.

e. Set the vertical amplifier plug-in unit volts/division switch to 0.5 V.

f. Set the high-frequency leveled sine-wave generator for a one-division display at 500 MHz. Center the display vertically on the graticule.

g. Set the MAIN TRIGGERING LEVEL control for a stable display (TRIG'D light on).

h. Check—for a stable display with no more than 0.05 division of jitter.

i. Check—change the MAIN TRIGGERING SOURCE to INT and repeat parts g and h of this step.

j. Disconnect the 50- Ω cable from the MAIN TRIG IN connector and reconnect it to the DLY'D TRIG IN connector.

k. Set the DLY'D Time/Division to PULL FOR ALT; set the Delayed Triggering SOURCE to EXT.

l. Set the Delayed Triggering LEVEL control for a stable display (near "0").

m. Check—for a stable display with no more than 0.05 division of jitter.

n. Check—change Delayed Triggering SOURCE to INT and repeat m of this step.

A14. Check HF Sync Triggering

a. Disconnect the 50- Ω cable from the DLY'D TRIG IN connector and reconnect it to the MAIN TRIG IN connector.

b. Set the Delayed Triggering LEVEL control to RUNS AFTER DELAY TIME.

c. Set the DLY'D Time/Division switch to Normal mode (knob in).

d. Set the MAIN TRIGGERING MODE to HF SYNC.

e. Set the vertical amplifier plug-in unit volts/division switch to 1 V.

f. Set the MAIN TRIGGERING LEVEL control for a stable display (TRIG'D light on).

g. Check—for a stable display with no more than 0.05 division of jitter.

h. Set the high-frequency leveled sine-wave generator for a one-division display.

i. Check—change the MAIN TRIGGERING SOURCE to EXT \div 10 and repeat part g of this step.

j. Disconnect the 50- Ω cable from the high-frequency leveled sine-wave generator.

A15. Check Line Triggering

a. Disconnect the 50- Ω cable from the MAIN TRIG IN connector.

b. Set the MAIN TRIGGERING MODE to AUTO, SOURCE to LINE, and COUPLING to AC; the TIME/DIV OR DLY TIME switch to 1 ms; and DLY'D Time/Division to 1 ms (knob in).

Performance Check/Calibration-7B92A

c. Check—set the MAIN TRIGGERING LEVEL control near "0" and check that the TRIG'D light is on.

d. Check—that the display is not triggered (TRIG'D light off) at either end of the MAIN TRIGGERING LEVEL control rotation.

d. Press the SINGLE SWEEP RESET pushbutton; it should be lit.

e. Check—change the MAIN TRIGGERING SOURCE to INT and observe that only one sweep is displayed and SINGLE SWEEP RESET pushbutton goes out.

f. Set the TIME/DIV OR DLY TIME switch to Alternate mode (PULL FOR ALT).

A16. Check Single Sweep Operation

a. Connect the time-mark generator to the input of the vertical amplifier plug-in unit, using a 50- Ω cable; set the generator for 1 ms markers.

b. Set the vertical amplifier plug-in unit deflection factor for approximately two divisions of display; and adjust MAIN TRIGGERING LEVEL control for a stable display.

c. Set the MAIN TRIGGERING SOURCE to INT, MODE to SINGLE SWEEP, and SOURCE to EXT.

g. Set the MAIN TRIGGERING SOURCE to EXT; press the SINGLE SWEEP RESET pushbutton. The pushbutton should be lit.

h. Check—change the MAIN TRIGGERING SOURCE to INT and observe that only one sweep is displayed and SINGLE SWEEP RESET pushbutton goes out.

i. Press SINGLE SWEEP RESET pushbutton several times and observe that display alternates between Delaying and Delayed sweeps.

B. TRIGGER SENSITIVITY (For instruments SN B069999-below)

Equipment Required

- | | |
|--|------------------------|
| 1. Oscilloscope | 6. Time-mark generator |
| 2. Wide-band vertical amplifier plug-in unit | 7. Digital voltmeter |
| 3. High-frequency signal generator | 8. Plug-in extender |
| 4. Medium-frequency signal generator | 9. Tee connector, bnc |
| 5. Low-frequency sine-wave generator | 10. 50-Ω cable (2) |

Control Settings

Set the 7B92A controls as follows:

MAIN TRIGGERING

SLOPE	+
LEVEL	Midrange
MODE	AUTO
COUPLING	AC
SOURCE	INT

Sweep Controls

POSITION	Midrange
TIME/DIV OR DLY TIME	20 μ s
DLY'D Time/Division	10 μ s/PULL FOR ALT
VARIABLE (CAL IN)	In
DELAY TIME MULT	1.0
TRACE SEP	Clockwise
INTENSITY	As desired
CONTRAST	As desired

Delayed Triggering

LEVEL	RUNS AFTER DELAY TIME
SLOPE	+
COUPLING	AC
SOURCE	INT

Inputs

TERM	1 M Ω (in)
------	-------------------

Vertical Amplifier Plug-In Unit

Position	Midrange
Polarity	+ up
Input Coupling	dc
Volts/Division	50 mV

B1. Preliminary Main Triggering Adjustment

a. Connect the bnc tee connector to the input of the vertical amplifier plug-in unit.

b. Connect a 50-Ω cable from the low-frequency sine-wave generator to the tee connector.

c. Connect a 50-Ω cable from the tee connector to the 7B92A MAIN TRIG IN connector.

d. Set the oscilloscope intensity and focus controls for the desired display.

e. Set the low-frequency sine-wave generator for a four-division display at 50 kHz (200 mV). Center the display vertically on the graticule.

f. Adjust—Int DC Bal, R25, Ext DC Bal, R59, and Trig Sens, R125, to midrange.

g. Adjust—Arming TD Bias, R145, and Gate TD Bias, R155, fully clockwise. The TRIG'D light should be on and the displayed waveform should be unstable.

Performance Check/Calibration-7B92A

h. Adjust—Gate TD Bias, R155, counterclockwise until a stable display occurs, then clockwise until display is unstable.

i. Connect the digital voltmeter between TP145 and chassis ground.

B2. Adjust Main Triggering Arming Tunnel Diode Bias

a. Adjust—Arming TD Bias, R145, counterclockwise until a stable display just occurs. Record the voltage at TP145; continue counterclockwise adjustment of R145 until TRIG'D light just goes out. Record the voltage at TP145.

b. Adjust—Arming TD Bias, R145, for the average of the two recorded voltage readings; disconnect the digital voltmeter.

B3. Adjust Main Triggering Gate Tunnel Diode Bias

a. Disconnect the delay line cable at connector J170.

b. Connect the digital voltmeter between TP155 and chassis ground.

c. If TRIG'D light is on and waveform display is stable, adjust Gate TD Bias, R155, counterclockwise until TRIG'D light just goes out.

d. Record the voltage at TP155.

e. Adjust—Gate TD Bias, R155, until TRIG'D light just goes out; then clockwise until waveform display is stable. Record the voltage at TP155.

f. Adjust—Gate TD Bias, R155, for the average of the two recorded voltage readings obtained in parts d and e of this step; disconnect the digital voltmeter.

B4. Adjust Main Triggering Internal DC Balance

a. Set the MAIN TRIGGERING COUPLING to AC; set the LEVEL control to "0".

b. Adjust—Int DC Bal, R25, for a stable crt display at graticule centerline (TRIG'D light on). See Fig. 5-9 for reference.

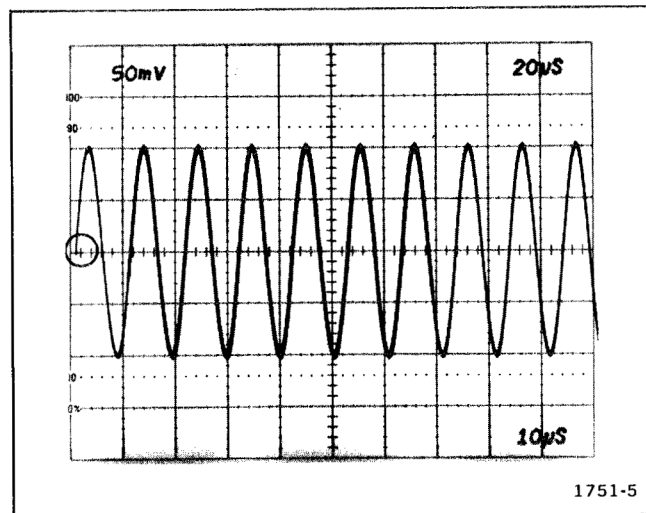

Fig. 5-9. DC balance. (Circle denotes correct trigger point.)

B5. Adjust Main Triggering Sensitivity

a. Adjust—Trig Sens, R125, for a sweep trigger point at approximately 0.5 division from bottom of waveform as MAIN TRIGGERING LEVEL control is rotated through negative (-) portion of its range. See Fig. 5-10 for reference.

B6. Adjust Main Triggering External DC Balance

a. Set the MAIN TRIGGERING SOURCE to EXT.

b. Adjust—Ext DC Bal, R59, for a sweep trigger point at graticule centerline. See Fig. 5-9 for reference.

B7. Check Main Triggering Level Range

a. Set MAIN TRIGGERING SOURCE to EXT.

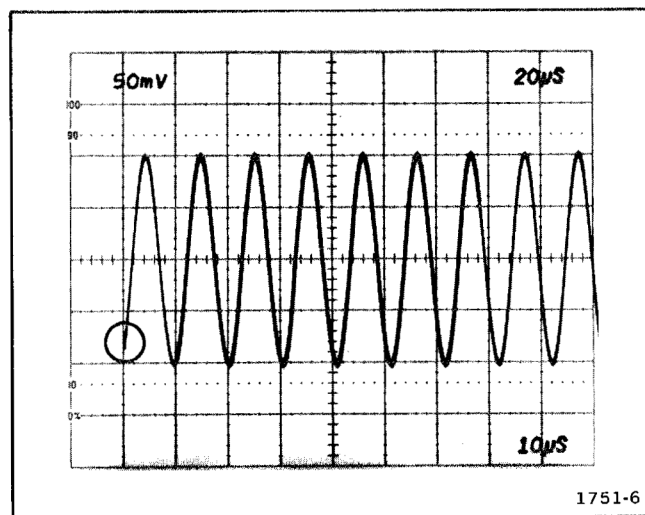

Fig. 5-10. Trigger sensitivity. (Circle denotes correct trigger point.)

b. Set the vertical amplifier plug-in unit volts/division switch to 1 V.

c. Set the low-frequency sine-wave generator for an eight-division display at 50 kHz. Center the display vertically on the graticule.

d. Check—that all levels of the positive slope may be selected for the sweep starting point as the MAIN TRIGGERING LEVEL control is rotated throughout its range, and that triggering occurs at least 3.5 divisions above and below the center horizontal graticule line. See Fig. 5-11 for reference.

e. Check—set the MAIN TRIGGERING SLOPE to — and repeat part d for the negative slope of the waveform.

f. Check—set the MAIN TRIGGERING SOURCE to EXT and repeat part d of this step.

g. Check—set the MAIN TRIGGERING SLOPE to + and repeat part d for the positive slope of the waveform.

B8. Preliminary Delayed Triggered Adjustment

a. Disconnect the 50-Ω cable from the MAIN TRIG IN connector and reconnect it to the DLY'D TRIG IN connector.

b. Set the 7B92A controls as follows:

MAIN TRIGGERING SOURCE	INT
MAIN TRIGGERING LEVEL	Near "0"
Delayed Triggering SLOPE	+
Delayed Triggering COUPLING	AC
Delayed Triggering SOURCE	INT
Delayed Triggering LEVEL	"0"
DELAY TIME MULT	1.0
TIME/DIV OR DLY TIME	20 μs
DLY'D Time/Division	10 μs/PULL FOR ALT

c. Adjust—Ext DC Bal, R225, Int DC Bal, R245, and Trig Sens, R325, to midrange.

d. Adjust—Arming TD Bias, R345, and Gate TD Bias, R355, fully clockwise.

e. Set the vertical amplifier plug-in unit volts/division switch to 50 mV.

f. Set the low-frequency sine-wave generator for a four-division display at 50 kHz. Center the display vertically on the graticule.

NOTE

Intensified zone should start at the beginning of Delaying (top) sweep.

g. Adjust—Gate TD Bias, R355, counterclockwise until intensified zone moves to right and disappears.

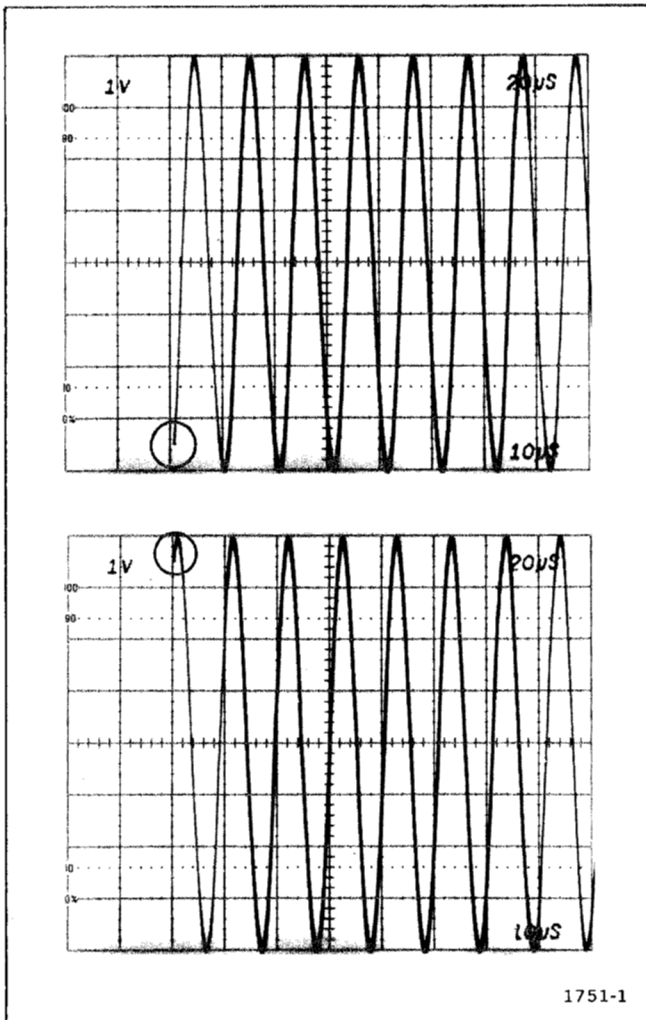

Fig. 5-11. Main Triggering level range. (Circle denotes triggering limits.)

Performance Check/Calibration-7B92A

h. Connect the digital voltmeter between TP345 and chassis ground.

B9. Adjust Delayed Triggering Arming Tunnel Diode Bias

a. Adjust—Arming TD Bias, R345, counterclockwise until Delayed sweep starts again. Record the voltage at TP345. Continue counterclockwise rotation of R345 until Delayed sweep again disappears. Record the voltage at TP345.

b. Adjust—Arming TD Bias, R345, for the average of the two voltage readings recorded in part a of this step. Delayed sweep should be visible.

B10. Adjust Delayed Triggering Gate Tunnel Diode Bias

a. Disconnect the digital voltmeter from TP345 and connect it to TP355; record the voltage.

b. Adjust—Gate Bias, R355, counterclockwise until Delayed sweep disappears. Record the voltage at TP355.

c. Adjust—Gate Bias, R355, for the average of the two voltage readings recorded in parts a and b of this step.

B11. Adjust Delayed Triggering Internal DC Balance

a. Set Delayed Triggering LEVEL control to "0".

b. Adjust—Int DC Bal, R245, for a Delayed sweep trigger point at graticule centerline. See Fig. 5-9 for reference.

B12. Adjust Delayed Triggering Sensitivity

a. Adjust—Trig Sens, R325, for a Delayed sweep trigger point at approximately 0.5 division from bottom of waveform as Delayed Triggering LEVEL control is rotated through negative (–) portion of its range. See Fig. 5-10 for reference.

NOTE

Setting trigger sensitivity so display is triggered at less than 0.1 division should be avoided to prevent erratic triggering.

B13. Adjust Delayed Triggering External DC Balance

a. Set Delayed Triggering SOURCE to EXT.

b. Adjust—Ext DC Bal, R225, for a Delayed sweep trigger point at graticule centerline. See Fig. 5-9 for reference.

B14. Check Delayed Triggering Level Range

a. Set the Delayed Triggering SOURCE to INT.

b. Set the vertical amplifier plug-in unit volts/division switch to 1 V.

c. Set the low-frequency sine-wave generator for an eight-division display at 50 kHz. Center the display vertically on the graticule. (Lower the Delaying sweep intensity control.)

d. Check—that all levels of the positive slope of the intensified zone may be selected for the sweep starting point as the Delayed Triggering LEVEL control is rotated throughout its range, and that triggering occurs at least 3.5 divisions above and below the center horizontal graticule line. See Fig. 5-12 for reference.

e. Check—set the Delayed Triggering SLOPE to – and repeat part d for the negative slope of the waveform.

f. Check—set the Delayed Triggering SOURCE to EXT and repeat part d of this step.

g. Check—set the Delayed Triggering SLOPE to + and repeat part d for the positive slope of the waveform.

B15. Check Low-Frequency Triggering

a. Disconnect the 50-Ω cable from the DLY'D TRIG IN connector and reconnect it to the MAIN TRIG IN connector.

b. Set the 7B92A controls as follows:

MAIN TRIGGERING	AC
COUPLING	
Delayed Triggering	+
SLOPE	
Delayed Triggering	AC
COUPLING	

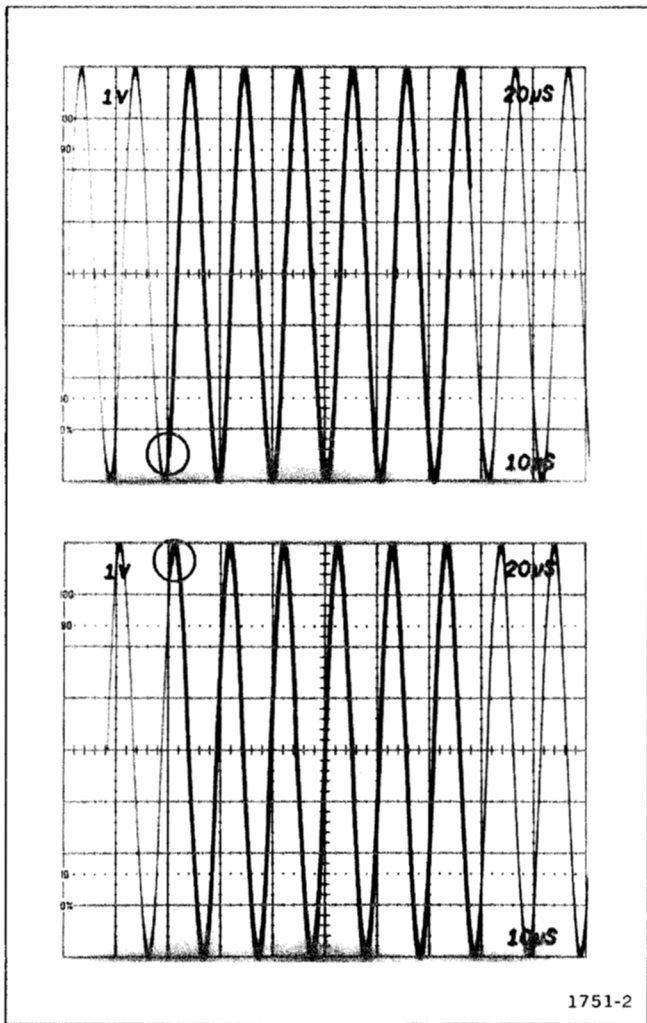

Fig. 5-12. Delayed Triggering level range. (Circle denotes triggering limits.)

Delayed Triggering SOURCE	INT
Delayed Triggering LEVEL	RUNS AFTER DELAY TIME
TIME/DIV OR DLY TIME	10 ms
DLY'D Time/Division	2 ms/PULL FOR ALT
DELAY TIME MULT	1.0
TRACE SEP	Clockwise

c. Set the vertical amplifier plug-in unit volts/division switch to 0.2 V.

d. Set the low-frequency sine-wave generator for a 0.5 division (100 millivolts) display at 30 Hz.

e. Check—for a stable display (TRIG'D light on) at all settings of the MAIN TRIGGERING LEVEL control with MAIN TRIGGERING COUPLING set to:

- (1.) AC
- (2.) AC HF REJ
- (3.) DC

(Set the MAIN TRIGGERING LEVEL control as necessary.)

f. Check—set the MAIN TRIGGERING SOURCE to EXT and repeat part e of this step.

g. Disconnect the 50-Ω cable from the MAIN TRIG IN connector and reconnect it to the DLY'D TRIG IN connector.

h. Set the control settings as follows:

MAIN TRIGGERING SOURCE	INT
Delayed Triggering LEVEL	near "0"
Delayed Triggering SOURCE	EXT

i. Check—for a stable display (TRIG'D light on) at all settings of LEVEL controls with Delayed Triggering COUPLING set to:

- (1.) AC
- (2.) DC

(Set the MAIN and Delayed Triggering LEVEL controls as necessary.)

j. Check—set the Delayed Triggering SOURCE to INT and repeat part i of this step.

B16. Check AC LF Reject Operation

a. Disconnect the 50-Ω cable from the DLY'D TRIG IN connector and reconnect it to the MAIN TRIG IN connector.

b. Set the vertical amplifier plug-in unit volts/division switch to 0.5 V.

c. Set the low-frequency sine-wave generator for an eight-division display at 60 Hz. Center the display vertically on the graticule.

d. Check—set the MAIN TRIGGERING LEVEL control for a stable display (TRIG'D light on).

Performance Check/Calibration-7B92A

e. Set the MAIN TRIGGERING COUPLING to AC LF REJ; set the MODE to NORM.

f. Check—for no display (TRIG'D light off) when the MAIN TRIGGERING LEVEL control is rotated throughout its range.

g. Set the MAIN TRIGGERING COUPLING to AC; set the SOURCE to EXT.

h. Reduce the output of the low-frequency sine-wave generator to provide a six-division display (3.0 V) at 60 Hz. (Adjust the MAIN TRIGGERING LEVEL control to maintain a stable display.)

i. Set the MAIN TRIGGERING COUPLING to AC LF REJ and repeat part f of this step.

B17. Check 20 MHz Triggering

a. Set the vertical amplifier plug-in unit volts/division switch to 0.2 V.

b. Set the 7B92A controls as follows:

MAIN TRIGGERING COUPLING	AC
MAIN TRIGGERING MODE	AUTO
MAIN TRIGGERING SOURCE	INT
Delayed Triggering COUPLING, SOURCE and SLOPE	All pushbuttons in
Delayed Triggering LEVEL	RUNS AFTER DELAY TIME
TIME/DIV OR DLY TIME	50 ns
DLY'D Time/Division	5 ns/PULL FOR ALT

c. Disconnect the 50-Ω cable from the low-frequency sine-wave generator and connect the medium-frequency signal generator to the vertical amplifier plug-in unit input using the 50-Ω cable.

d. Set the medium-frequency signal generator for a 0.5 division display (100 mV) at 20 MHz.

e. Check—for a stable display (TRIG'D light on) with the MAIN TRIGGERING COUPLING switch set to:

- (1.) AC
- (2.) AC LF REJ
- (3.) DC

(Set the MAIN TRIGGERING LEVEL control as necessary.)

f. Check—change the MAIN TRIGGERING SOURCE to EXT and repeat part e of this step.

g. Disconnect the 50-Ω cable from the MAIN TRIG IN connector and reconnect it to the DLY'D TRIG IN connector.

h. Set the Delayed Triggering LEVEL control near "0".

i. Set the MAIN TRIGGERING SOURCE to INT and MAIN TRIGGERING COUPLING to AC.

j. Check—for a stable display (TRIG'D light on) with the Delayed Triggering COUPLING switch set to:

- (1.) AC
- (2.) DC

k. Set the Delayed Triggering SOURCE to EXT and repeat part j of this step.

l. Disconnect the 50-Ω cable from the medium-frequency signal generator; disconnect the 50-Ω cable from the bnc tee at the vertical amplifier plug-in input connector.

B18. Check 500 MHz Triggering

a. Connect the high-frequency leveled sine-wave generator to the bnc tee connected to the vertical amplifier plug-in unit input.

b. Disconnect the 50-Ω cable from the DLY'D TRIG IN connector and reconnect it to the MAIN TRIG IN connector.

c. Set the 7B92A controls as follows:

MAIN TRIGGERING COUPLING	DC
MAIN TRIGGERING SOURCE	EXT
TIME/DIV OR DLY TIME	1 ns
DLY'D Time/Division	1 ns (knob in)

d. Adjust the oscilloscope intensity control for normal viewing.

e. Set the vertical amplifier plug-in unit volts/division switch to 0.5 V.

f. Set the high-frequency leveled sine-wave generator for a one-division display at 500 MHz. Center the display vertically on the graticule.

g. Set the MAIN TRIGGERING LEVEL control for a stable display (TRIG'D light on).

h. Check—for a stable display with no more than 0.05 division of jitter.

i. Check—change the MAIN TRIGGERING SOURCE to INT and repeat parts g and h of this step.

j. Disconnect the 50- Ω cable from the MAIN TRIG IN connector and reconnect it to the DLY'D TRIG IN connector.

k. Set the DLY'D Time/Division to PULL FOR ALT; set the Delayed Triggering SOURCE to EXT.

l. Set the Delayed Triggering LEVEL control for a stable display (near "0").

m. Check—for a stable display with no more than 0.05 division of jitter.

n. Check—change Delayed Triggering SOURCE to INT and repeat m of this step.

B19. Check HF Sync Triggering

a. Disconnect the 50- Ω cable from the DLY'D TRIG IN connector and reconnect it to the MAIN TRIG IN connector.

b. Set the Delayed Triggering LEVEL control to RUNS AFTER DELAY TIME.

c. Set the DLY'D Time/Division switch to Normal mode (knob in).

d. Set the MAIN TRIGGERING MODE to HF SYNC.

e. Set the vertical amplifier plug-in unit volts/division switch to 1 V.

f. Set the MAIN TRIGGERING LEVEL control for a stable display (TRIG'D light on).

g. Check—for a stable display with no more than 0.05 division of jitter.

h. Set the high-frequency leveled sine-wave generator for a one-division display.

i. Check—change the MAIN TRIGGERING SOURCE to EXT \div 10 and repeat part g of this step.

j. Disconnect the 50- Ω cable from the high-frequency leveled sine-wave generator.

B20. Check Line Triggering

a. Disconnect the 50- Ω cable from the MAIN TRIG IN connector.

b. Set the MAIN TRIGGERING MODE to AUTO, SOURCE to LINE, and COUPLING to AC; the TIME/DIV OR DLY TIME switch to 1 ms; and DLY'D Time/Division to 1 ms (knob in).

c. Check—set the MAIN TRIGGERING LEVEL control near "0" and check that the TRIG'D light is on.

d. Check—that the display is not triggered (TRIG'D light off) at either end of the MAIN TRIGGERING LEVEL control rotation.

B21. Check Single Sweep Operation

a. Connect the time-mark generator to the input of the vertical amplifier plug-in unit, using a 50- Ω cable; set the generator for 1 ms markers.

b. Set the vertical amplifier plug-in unit deflection factor for approximately two divisions of display; and adjust MAIN TRIGGERING LEVEL control for a stable display.

Performance Check/Calibration-7B92A

c. Set the MAIN TRIGGERING SOURCE to INT, MODE to SINGLE SWEEP, and SOURCE to EXT.

d. Press the SINGLE SWEEP RESET pushbutton; it should be lit.

e. Check—change the MAIN TRIGGERING SOURCE to INT and observe that only one sweep is displayed and SINGLE SWEEP RESET pushbutton goes out.

f. Set the TIME/DIV OR DLY TIME switch to Alternate mode (PULL FOR ALT).

g. Set the MAIN TRIGGERING SOURCE to EXT; press the SINGLE SWEEP RESET pushbutton. The pushbutton should be lit.

h. Check—change the MAIN TRIGGERING SOURCE to INT and observe that only one sweep is displayed and SINGLE SWEEP RESET pushbutton goes out.

i. Press SINGLE SWEEP RESET pushbutton several times and observe that display alternates between Delaying and Delayed sweeps.

C. HORIZONTAL SYSTEM

Equipment Required

- | | |
|--|---------------------|
| 1. Oscilloscope | 5. 50-Ω termination |
| 2. Wide-band Vertical amplifier plug-in unit | 6. 50-Ω cable |
| 3. Time-mark generator | 7. Screwdriver |
| 4. Calibration generator | |

C1. Set Basic Sweep Calibration

- a. Set the 7B92A controls as follows:

MAIN TRIGGERING

SLOPE	+
LEVEL	Midrange
MODE	NORM
COUPLING	AC
SOURCE	INT

Sweep Controls

POSITION	Midrange
TIME/DIV OR DLY TIME	1 ms
DLY'D Time/Division	1 ms (knob in)

Delayed Triggering

LEVEL	RUNS AFTER DELAY TIME
SLOPE	+
COUPLING	AC
SOURCE	INT

Inputs

TERM	1 MΩ (pushbutton in)
------	----------------------

b. Connect the time-mark generator to the vertical amplifier plug-in unit input with a 50-Ω cable. Set the time-mark generator for 1 ms markers.

c. Set the oscilloscope intensity and focus controls for a desired display.

d. Set the vertical amplifier plug-in unit for approximately two divisions of display. Position the display in the center graticule area. Set the MAIN TRIGGERING LEVEL control for a stable display (TRIG'D light on).

e. Set the front-panel SWP CAL adjustment for one marker/division over the center eight divisions (position as necessary).

- f. Set the 7B92A controls as follows:

TIME/DIV OR DLY TIME	1 ms
DLY'D Time/Division	0.2 ms/PULL FOR ALT
TRACE SEP	Fully clockwise

C2. Check Trace Separation Range (SN B059999-below)

a. Check—for Delaying sweep (with intensified zone) positioned at least 3.5 divisions above Delayed sweep.

C3. Check Trace Separation Range and Alt Off Function (SN B060000-above)

a. Check—for Delaying sweep (with intensified zone) positioned at least 3.5 divisions above Delayed sweep.

b. Set TRACE SEP control fully counterclockwise (ALT OFF).

c. Check—that Delaying sweep (with intensified zone) is not alternating with Delayed sweep, and no readout exists.

C4. Adjust DTM Scale and Delay Start

a. Set the DLY'D Time/Division switch to 10 μs; set the TRACE SEP control fully clockwise.

Performance Check/Calibration-7B92A

- b. Set the DELAY TIME MULT dial to 9.00.
- c. Position the first time-mark to the second vertical graticule line, using the POSITION control. See Fig. 5-13 for reference.
- d. Adjust—DTMScale, R495, to start rising portion of tenth time-mark so Delayed (bottom) sweep display coincides with second vertical graticule line. See Fig. 5-13 for reference.
- e. Set the DELAY TIME MULT dial to 1.00.
- f. Adjust—Delay Start, R425, to start rising portion of second time-mark so Delayed (bottom) sweep display coincides with second vertical graticule line. See Fig. 5-13 for reference.
- g. Interaction—repeat the adjustment of R495 and R425 as necessary.

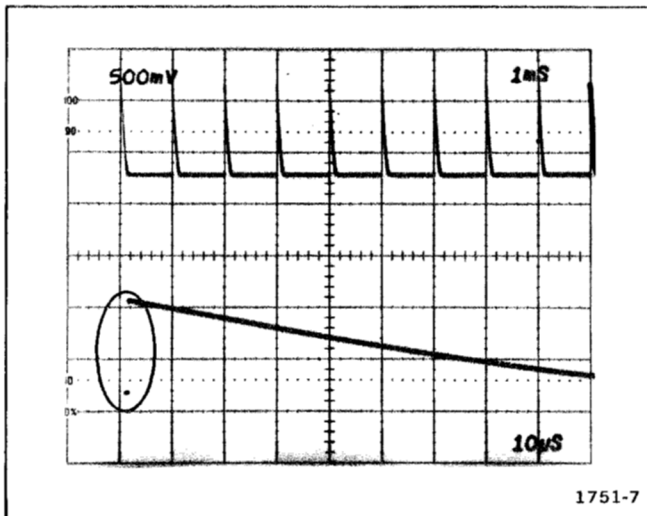

Fig.5-13. Correct DTM Scale and Delay Start adjustment (circle).

C5. Adjust Delaying Sweep Calibration

- a. Set TIME/DIV OR DLY TIME and DLY'D Time/Division switch to 1 ms, and pull DLY'D Time/Division knob out for alternate mode.
- b. Adjust—Delaying Sweep Cal, R458, for one time-mark per division over center eight graticule divisions.

C6. Adjust Sweep Registration

- a. Set DELAY TIME MULT dial to 0.0.

b. Adjust—Sweep Registration, R525, to align first time-mark of Delayed sweep with first time-mark of Delaying sweep.

c. Interaction—repeat the adjustment of R458 and R525 as necessary.

C7. Adjust Position Centering

- a. Set the time-mark generator for 2 ms markers.
- b. Set the POSITION control fully counterclockwise.
- c. Adjust—Position Centering, R935, to align the second time-mark with the left (first) vertical graticule line.
- d. Set the POSITION control fully clockwise.
- e. Check—that the sweeps start to the right of graticule center.

C8. Check Sweep Length

See Step B5.A. Page 5-12.

C9. Adjust 2 ns Timing

- a. Set the TIME/DIV OR DLY TIME and DLY'D Time/Division switch to 2 ns (knob pushed in).
- b. Set the time-mark generator for 2 ns markers.
- c. Set the vertical amplifier plug-in unit deflection factor for a two-division display.
- d. Adjust the MAIN TRIGGERING LEVEL control for a stable display (TRIG'D light on).
- e. Align the second time-mark to the second vertical graticule line, using the POSITION control.
- f. Check—that the tenth time-mark is within 0.32 division of tenth vertical graticule line.

g. Adjust—2 ns Timing, C540, for one time-mark per division over center eight graticule divisions.

C10. Adjust Delayed Sweep 20 ns Timing

a. Set TIME/DIV OR DLY TIME and DLY'D Time/Division switch to 20 ns (knob pushed in).

b. Set the time-mark generator for 20 ns markers.

c. Set the vertical amplifier plug-in unit deflection factor for a two-division display.

d. Adjust the MAIN TRIGGERING LEVEL control for a stable display (TRIG'D light on).

e. Align the second time-mark to the second vertical graticule line, using the POSITION control.

f. Check—that the tenth time-mark is within 0.16 division of tenth vertical graticule line.

g. Adjust—20 ns Timing, C721, for one time-mark per division over center eight graticule divisions.

C11. Adjust Delaying Sweep 20 ns Timing

a. Set the TIME/DIV OR DLY TIME and DLY'D Time/Division switch to 20 ns, and pull DLY'D Time/Division knob out.

b. Set the DELAY TIME MULT dial to 3.00.

c. Align the second time-mark to the second vertical graticule line, using the POSITION control.

d. Check—that the tenth time-mark is within 0.16 division of tenth vertical graticule line.

e. Adjust—20 ns Timing, C440, for one time-mark per division over center eight graticule divisions.

f. Align the display to place leading edge of Delayed sweep time-mark at intersection of horizontal and vertical graticule centerlines, using the POSITION control and the vertical amplifier position control.

g. Set the DELAY TIME MULT dial to 9.00.

h. Adjust—20 ns Timing, C440, to position the leading edge of the time-mark at the intersection of horizontal and vertical graticule centerlines.

i. Set the DELAY TIME MULT dial to 3.00.

j. Repeat part f of this step.

k. Interaction—repeat parts f through i of this step as necessary.

l. Disconnect the 50- Ω cable from the time-mark generator.

C12. Adjust Time Position

a. Connect a 50- Ω termination to the fast-rise output of the calibration generator; connect a 50- Ω cable to the termination.

b. Set the vertical amplifier plug-in unit deflection factor for a three-division display.

c. Remove the 7B92A from the extender and remove the extender from the oscilloscope plug-in compartment; install the 7B92A into the plug-in compartment.

d. Set the TIME/DIV OR DLY TIME switch to 2 ns (knob pushed in).

e. Set the MAIN TRIGGERING LEVEL control for a stable display (TRIG'D light on), and set the oscilloscope intensity control for desired display.

f. Set the POSITION control fully clockwise.

g. Check—the leading edge of the pulse for a setting to the right of graticule center.

h. Remove the 7B92A from the oscilloscope plug-in compartment and re-install the 7B92A with extender into the compartment.

i. Adjust—Time Positioning, R925, to position leading edge of pulse 3.5 divisions from left side of graticule.

j. Repeat parts c and g of this step.

Performance Check/Calibration-7B92A

k. Disconnect the 50-Ω cable from the calibration generator.

a. Set the TIME/DIV OR DLY TIME, DLY'D Time/Division in Alternate mode (PULL FOR ALT), and time-mark generator as indicated in Table 5-7; set DELAY TIME MULT dial to 0.0.

C13. Check Sweep Timing

NOTE

The tolerances given in Table 5-7 are for ambient temperature range of +15°C to +35°C. If outside this range, see the Specification section for applicable tolerances.

b. Check—using the settings given in Table 5-7, check sweep accuracy for one time mark/division over the center eight divisions within the tolerance given in Table 5-7. Set the POSITION control and MAIN TRIGGERING LEVEL control as necessary for a stable display that is aligned with the vertical graticule lines.

**Table 5-7
SWEEP TIMING**

TIME/DIV OR DLY TIME	DLY'D Time/Division	Time-Mark Generator Setting	Tolerance (+15°C to +35°C)	
			Delaying Sweep	Delayed Sweep
0.2 s	0.2 s	0.2 s	Within 0.16 div	Within 0.16 div
0.1 s	0.1 s	0.1 s	Within 0.16 div	Within 0.16 div
50 ms	50 ms	50 ms	Within 0.16 div	Within 0.16 div
20 ms	20 ms	20 ms	Within 0.16 div	Within 0.16 div
10 ms	10 ms	10 ms	Within 0.16 div	Within 0.16 div
5 ms	5 ms	5 ms	Within 0.16 div	Within 0.16 div
2 ms	2 ms	2 ms	Within 0.16 div	Within 0.16 div
1 ms	1 ms	1 ms	Within 0.16 div	Within 0.16 div
0.5 ms	0.5 ms	0.5 ms	Within 0.16 div	Within 0.16 div
0.2 ms	0.2 ms	0.2 ms	Within 0.16 div	Within 0.16 div
0.1 ms	0.1 ms	0.1 ms	Within 0.16 div	Within 0.16 div
50 μs	50 μs	50 μs	Within 0.16 div	Within 0.16 div
20 μs	20 μs	20 μs	Within 0.16 div	Within 0.16 div
10 μs	10 μs	10 μs	Within 0.16 div	Within 0.16 div
5 μs	5 μs	5 μs	Within 0.16 div	Within 0.16 div
2 μs	2 μs	2 μs	Within 0.16 div	Within 0.16 div
1 μs	1 μs	1 μs	Within 0.16 div	Within 0.16 div
0.5 μs	0.5 μs	0.5 μs	Within 0.16 div	Within 0.16 div
0.2 μs	0.2 μs	0.2 μs	Within 0.16 div	Within 0.16 div
0.1 μs	0.1 μs	0.1 μs	Within 0.16 div	Within 0.16 div
50 ns	50 ns	50 ns	Within 0.16 div	Within 0.16 div
20 ns	20 ns	20 ns	Within 0.16 div	Within 0.16 div
10 ns	10 ns	10 ns	Within 0.24 div	Within 0.24 div

NOTE

If the time-mark generator used does not have 1-2-5 sequence markers, apply 1 unit markers in place of 2 unit markers and check for 2 markers/division over the center eight divisions of display, to the tolerances given in Table 5-7.

d. Check—using the settings given in Table 5-8, check sweep accuracy over the center eight divisions within the tolerance given in Table 5-8.

NOTE

The HF SYNC MODE switch may provide a better display when checking the fastest sweep rates.

c. Push in the DLY'D Time/Division knob and position the display to the center of the graticule.

**Table 5-8
FAST TIMING**

TIME/DIV OR DLY TIME	Time-Mark Generator Setting	Display Markers/Division	Tolerance (+15°C to +35°C)
5 ns	5 ns	1	Within 0.24 div
2 ns	2 ns	1	Within 0.32 div
1 ns	1 ns	1	Within 0.32 div
0.5 ns	1 ns	1 cycle/2 div	Within 0.40 div

C14. Check Sweep Linearity

a. Set the TIME/DIV OR DLY TIME and DLY'D Time/Division switch to 1 ms and pull DLY'D Time/Division knob out for Alternate mode.

b. Set the time-mark generator for 1 ms markers.

c. Position the Delaying (top) and Delayed-sweep traces horizontally to start on the first graticule line.

d. Check—that the fourth marker of the Delaying sweep coincides within 0.1 division with the fourth vertical graticule line.

e. Check—continue linearity check, as in part d of this step, for each successive two divisions of the Delaying sweep.

f. Check—repeat parts d and e of this step to check linearity of the Delayed (bottom) sweep.

g. Set the TIME/DIV OR DLY TIME and DLY'D Time/Division switch to 10 ns and pull DLY'D Time/Division knob out for Alternate mode.

h. Set the time-mark generator for 10 ns markers.

i. Check—perform linearity check as in parts d, e, and f of this step. Tolerance is 0.1 division for each two divisions over center eight graticule divisions.

j. Set the DLY'D Time/Division to Normal mode (knob in).

k. Check—continue linearity check for Delayed sweep rates as shown in Table 5-9.

**Table 5-9
FAST SWEEP LINEARITY**

Time/ Division	Time-mark Generator Setting	Markers/ 2 Divisions	Tolerance/ 2 Divisions
5 ns	5 ns	2	0.2 div
2 ns	2 ns	2	0.2 div
1 ns	1 ns	2	0.2 div
0.5 ns	1 ns	1	0.2 div

Performance Check/Calibration-7B92A

C15. Check Variable Time/Division Range

- a. Remove the 7B92A from the oscilloscope plug-in compartment.
- b. Place the Time/Division Variable Selector multi-pin connector on P761 (Delaying Sweep). See Fig. 1-1 for location.
- c. Insert the 7B92A into the oscilloscope plug-in compartment; turn on the power to the oscilloscope.
- d. Set the time-mark generator for $100\ \mu\text{s}$ markers.
- e. Set the TIME/DIV OR DLY TIME and DLY'D Time/Division switch to $20\ \mu\text{s}$ and pull DLY'D Time/Division knob out for Alternate mode. Check that the DELAY TIME MULT dial is 0.0.

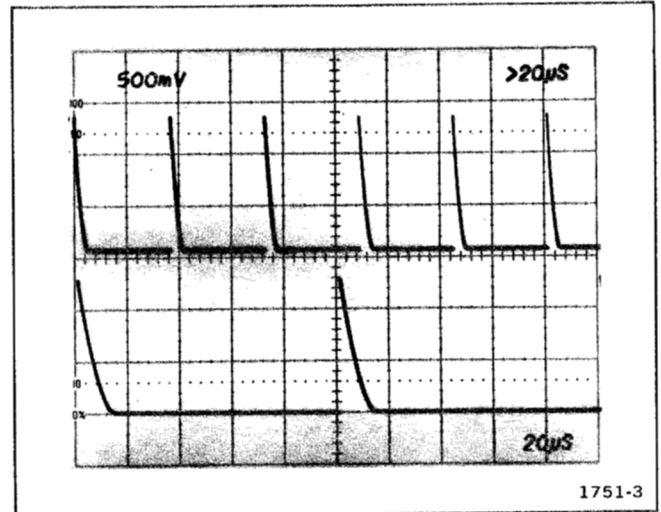

Fig. 5-14. Variable Time/Division range.

- f. Press and release VARIABLE control and turn it fully counterclockwise.
- g. Check—that Delaying sweep markers (top) and Delayed sweep markers are displayed as shown in Fig. 5-8; at least 2-1/2 Delaying sweep markers to one Delayed sweep marker are visible.
- h. Remove the 7B92A from the oscilloscope plug-in compartment; reposition the Time/Division Variable Selector multi-pin connector to P760 and re-install the 7B92A into the plug-in compartment. Turn on power to the oscilloscope.
- i. Check—with VARIABLE control released and turned fully counterclockwise, at least two Delayed sweep markers (bottom) to one Delaying sweep marker is visible. Refer to Fig. 5-14.

C16. Check Differential Delay Time Accuracy

- a. Set the TIME/DIV OR DLY TIME switch to 200 ms, DLY'D Time/Division switch (pull knob out) to 5 ms (then push knob in), push in VARIABLE (CAL IN) control, and adjust MAIN TRIGGERING LEVEL control for a stable display (TRIG'D light on).

- b. Set the time-mark generator for 100 ms markers.
- c. Set the vertical amplifier plug-in unit deflection factor for approximately two divisions of display.
- d. Set the DELAY TIME MULT dial to 0.90.
- e. Align the time-mark to the center vertical graticule line, using the POSITION control.
- f. Turn the DELAY TIME MULT dial to approximately 8.9 to align the time-mark to the center vertical graticule line.
- g. Check—the DELAY TIME MULT dial to read within three minor divisions of 8.9 (8.84 to 8.96).
- h. Repeat parts d through g of this step for each sweep rate given in Table 5-10. Maintain approximately two divisions of display.

Table 5-10

DIFFERENTIAL DELAY TIME ACCURACY

TIME/DIV OR DLY TIME	DLY'D Time/Division	Time-mark Generator Setting
.2 s	5 ms	0.1 s
.1 s	2 ms	50 ms
50 ms	1 ms	10 ms
20 ms	0.5 ms	10 ms
10 ms	0.2 ms	5 ms
5 ms	0.1 ms	1 ms
2 ms	50 μ s	1 ms
1 ms	20 μ s	0.5 ms
.5 ms	10 μ s	0.1 ms
.2 ms	5 μ s	0.1 ms
.1 ms	2 μ s	50 μ s
50 μ s	1 μ s	10 μ s
20 μ s	.5 μ s	10 μ s
10 μ s	.2 μ s	5 μ s
5 μ s	.1 μ s	1 μ s
2 μ s	50 ns	1 μ s
1 μ s	20 ns	0.5 μ s
.5 μ s	10 ns	0.1 μ s
.2 μ s	5 ns	50 ns
.1 μ s	5 ns	50 ns

C17. Check Fast Delay Time Accuracy

- a. Set the TIME/DIV OR DLY TIME switch to 50 ns, DLY'D Time/Division switch (pull knob out) to 10 ns (then push knob in), and adjust the MAIN TRIGGERING LEVEL control for a stable display (TRIG'D light on).
- b. Set the time-mark generator for 50 ns markers.
- c. Set the vertical amplifier plug-in unit deflection factor for approximately two divisions of display.
- d. Set the DELAY TIME MULT dial to 9.00.

- e. Align the leading edge of the time-mark to the center vertical graticule line, using the POSITION control. See Fig. 5-15 for reference.

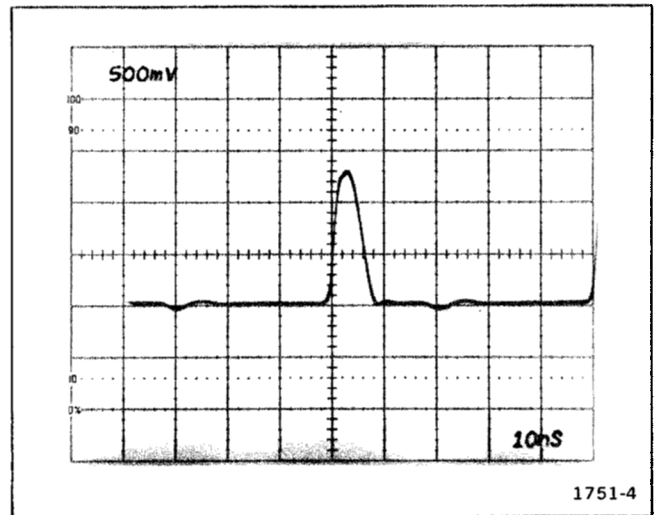

Fig. 5-15. Fast delay time accuracy.

- f. Check—set the DELAY TIME MULT dial to the settings listed in Table 5-11, and check for maximum error in dial reading.

Table 5-11

FAST DIFFERENTIAL DELAY TIME ACCURACY

DELAY TIME MULT	Maximum Error (Minor Dial Divisions)
9.0	0 (step e)
8.0	Within 3.0
7.0	Within 3.5
6.0	Within 4.0
5.0	Within 4.5
4.0	Within 5.0
3.0	Within 3.0
2.0	Within 6.0
1.0	Within 6.5

- g. Set the TIME/DIV OR DLY TIME switch to 20 ns, DLY'D Time/Division switch (pull knob out) to 2 ns (then push knob in), and adjust the MAIN TRIGGERING LEVEL control for a stable display (TRIG'D light on).
- h. Set the time-mark generator for 20 ns markers.

Performance Check/Calibration-7B92A

i. Repeat parts d, e, and f of this step.

j. Set the TIME/DIV OR DLY TIME switch to 10 ns, DLY'D Time/Division switch (pull knob out) to 1 ns (then push knob in), and adjust the MAIN TRIGGERING LEVEL control for a stable display (TRIG'D light on).

k. Set the time-mark generator for 10 ns markers.

l. Repeat parts d, e, and f of this step. Delete check at DELAY TIME MULT dial setting of 1.0.

C18. Check Delay Jitter

a. Set the TIME/DIV OR DLY TIME switch to 1 ms, DLY'D Time/Division switch (pull knob out) to 5 ns (then push knob in), and adjust the MAIN TRIGGERING LEVEL control for a stable display (TRIG'D light on).

b. Set the time-mark generator for 1 ms markers.

c. Set the DELAY TIME MULT dial to approximately 1.0 (position the time-mark to the center of the graticule).

d. Set the DLY'D Time/Division switch to 0.2 μ s.

e. Turn the DELAY TIME MULT dial slowly to position the time-mark near the graticule center (turn up INTENSITY control as necessary).

f. Check—jitter must not exceed one division (disregard slow drift).

g. Set the TIME/DIV OR DLY TIME switch to 20 μ s, DLY'D Time/Division switch (pull knob out) to 50 ns (then push knob in), and adjust the MAIN TRIGGERING LEVEL control for a stable display (TRIG'D light on).

h. Set the time-mark generator for 50 ns markers.

i. Set the DLY'D Time/Division switch to 5 ns.

j. Turn the DELAY TIME MULT dial slowly to position the time-mark near the graticule center (turn up INTENSITY control as necessary).

k. Check—jitter must not exceed 0.9 division.

l. Turn the DELAY TIME MULT dial to approximately 9.0 and position the time-mark to the center of the graticule.

m. Check—jitter must not exceed 0.8 division.

This completes the Calibration procedure of the 7B92A.

OPTIONS

No Options available at the time of this printing. Refer to the CHANGE INFORMATION in the back of this manual for Options available after this printing.

REPLACEABLE ELECTRICAL PARTS

PARTS ORDERING INFORMATION

Replacement parts are available from or through your local Tektronix, Inc. Field Office or representative.

Changes to Tektronix instruments are sometimes made to accommodate improved components as they become available, and to give you the benefit of the latest circuit improvements developed in our engineering department. It is therefore important, when ordering parts, to include the following information in your order: Part number, instrument type or number, serial number, and modification number if applicable.

If a part you have ordered has been replaced with a new or improved part, your local Tektronix, Inc. Field Office or representative will contact you concerning any change in part number.

Change information, if any, is located at the rear of this manual.

SPECIAL NOTES AND SYMBOLS

X000 Part first added at this serial number
00X Part removed after this serial number

ITEM NAME

In the Parts List, an Item Name is separated from the description by a colon (:). Because of space limitations, an Item Name may sometimes appear as incomplete. For further Item Name identification, the U.S. Federal Cataloging Handbook H6-1 can be utilized where possible.

ABBREVIATIONS

ACTR	ACTUATOR	PLSTC	PLASTIC
ASSY	ASSEMBLY	QTZ	QUARTZ
CAP	CAPACITOR	RECP	RECEPTACLE
CER	CERAMIC	RES	RESISTOR
CKT	CIRCUIT	RF	RADIO FREQUENCY
COMP	COMPOSITION	SEL	SELECTED
CONN	CONNECTOR	SEMICOND	SEMICONDUCTOR
ELCTLT	ELECTROLYTIC	SENS	SENSITIVE
ELEC	ELECTRICAL	VAR	VARIABLE
INCAND	INCANDESCENT	WW	WIREWOUND
LED	LIGHT EMITTING DIODE	XFMR	TRANSFORMER
NONWIR	NON WIREWOUND	XTAL	CRYSTAL

CROSS INDEX - MFR. CODE NUMBER TO MANUFACTURER

Mfr. Code	Manufacturer	Address	City, State, Zip Code
00853	SANGAMO WESTON INC SANGAMO CAPACITOR DIV	SANGAMO RD P O BOX 128	PICKENS SC 29671
01121	ALLEN-BRADLEY CO	1201 SOUTH 2ND ST	MILWAUKEE WI 53204
01295	TEXAS INSTRUMENTS INC SEMICONDUCTOR GROUP	13500 N CENTRAL EXPRESSWAY P O BOX 225012 M/S 49	DALLAS TX 75265
01963	CHERRY ELECTRICAL PRODUCTS CORP	3600 SUNSET AVE	WAUKEGAN IL 60085
02111	SPECTROL ELECTRONICS CORP SUB OF CARRIER CORP	17070 E GALE AVE P O BOX 1220	CITY OF INDUSTRY CA 91749
02114	AMPEREX ELECTRONIC CORP FERROXCUBE DIV	5083 KINGS HWY	SAUGERTIES NY 12477
03508	GENERAL ELECTRIC CO SEMI-CONDUCTOR PRODUCTS DEPT	W GENESEE ST	AUBURN NY 13021
04222	AVX CERAMICS DIV OF AVX CORP	19TH AVE SOUTH P O BOX 867	MYRTLE BEACH SC 29577
04713	MOTOROLA INC SEMICONDUCTOR GROUP	5005 E MCDOWELL RD	PHOENIX AZ 85008
05397	UNION CARBIDE CORP MATERIALS SYSTEMS DIV	11901 MADISON AVE	CLEVELAND OH 44101
07263	FAIRCHILD CAMERA AND INSTRUMENT CORP SEMICONDUCTOR DIV	464 ELLIS ST	MOUNTAIN VIEW CA 94042
07716	TRW INC TRW ELECTRONICS COMPONENTS TRW IRC FIXED RESISTORS/BURLINGTON	2850 MT PLEASANT AVE	BURLINGTON IA 52601
08806	GENERAL ELECTRIC CO MINIATURE LAMP PRODUCTS DEPT	NELA PK	CLEVELAND OH 44112
10389	ILLINOIS TOOL WORKS INC	1714 N DAMEN AVE	CHICAGO IL 60647
12617	HAMLIN INC	GROVE AND LAKE STS	LAKE MILLS WI 53551
12697	CLAROSTAT MFG CO INC	LOWER WASHINGTON ST	DOVER NH 03820
14193	CAL-R INC	1601 OLYMPIC BLVD	SANTA MONICA CA 90404
14433	ITT SEMICONDUCTORS DIV		WEST PALM BEACH FL
18324	SIGNETICS CORP	811 E ARQUES	SUNNYVALE CA 94086
19396	ILLINOIS TOOL WORKS INC PAKTRON DIVISION	900 FOLLIN LANE S E	VIENNA VA 22180
19701	MEPCO/ELECTRA INC A NORTH AMERICAN PHILIPS CO	P O BOX 760	MINERAL WELLS TX 76067
24546	CORNING GLASS WORKS	550 HIGH ST	BRADFORD PA 16701
28733	CERAMIC MAGNETICS INC	87 FAIRFIELD RD	FAIRFIELD NJ 07006
31433	UNION CARBIDE CORP ELECTRONICS DIV	PO BOX 5928	GREENVILLE SC 29606
31918	ITT SCHADOW INC	8081 WALLACE RD	EDEN PRAIRIE MN 55343
32293	INTERSIL INC	10900 N TANTAU AVE	CUPERTINO CA 95014
32997	BOURNS INC TRIMPOT DIV	1200 COLUMBIA AVE	RIVERSIDE CA 92507
50347	OPCOA DIV OF IDS	330 TALMADGE RD	EDISON NJ 08817
50434	HEWLETT-PACKARD CO OPTOELECTRONICS DIV	640 PAGE MILL RD	PALO ALTO CA 94304
52763	STETTNER ELECTRONICS INC	6135 AIRWAYS BLVD PO BOX 21947	CHATTANOOGA TN 37421
54473	MATSUSHITA ELECTRIC CORP OF AMERICA	ONE PANASONIC WAY	SECAUCUS NJ 07094
54583	TDK ELECTRONICS CORP	755 EASTGATE BLVD	GARDEN CITY NY 11530
56289	SPRAGUE ELECTRIC CO	87 MARSHALL ST	NORTH ADAMS MA 01247
57668	ROHM CORP	16931 MILLIKEN AVE	IRVINE CA 92713
58854	GTE PRODUCTS CORP LIGHTING PRODUCTS GROUP	60 BOSTON ST	SALEM MA 01970
59660	TUSONIX INC	2155 N FORBES BLVD	TUCSON, ARIZONA 85705
59821	CENTRALAB INC SUB NORTH AMERICAN PHILIPS CORP	7158 MERCHANT AVE	EL PASO TX 79915
71590	GLOBE-UNION INC CENTRALAB ELECTRONICS DIV	HWY 20 W P O BOX 858	FORT DODGE IA 50501
72982	ERIE TECHNOLOGICAL PRODUCTS INC	645 W 11TH ST	ERIE PA 16512
74970	JOHNSON E F CO	299 10TH AVE S W	WASECA MN 56093
75042	INTERNATIONAL RESISTIVE CO INC	401 N BROAD ST	PHILADELPHIA PA 19108
80009	TEKTRONIX INC	4900 S W GRIFFITH DR P O BOX 500	BEAVERTON OR 97077
91637	DALE ELECTRONICS INC	P O BOX 609	COLUMBUS NE 68601
TK1345	ZMAN AND ASSOCIATES	7633 S 180TH	KENT WA 98032

CROSS INDEX - MFR. CODE NUMBER TO MANUFACTURER

Mfr. Code	Manufacturer	Address	City, State, Zip Code
TK2042	ZMAN & ASSOCIATES	7633 SO. 180TH	KENT, WA 98032

Replaceable Electrical Parts - 7B92A

Component No.	Tektronix Part No.	Serial/Assembly No. Effective	Dscont	Name & Description	Mfr. Code	Mfr. Part No.
A1	670-3275-00			CIRCUIT BD ASSY:EXT INPUT	80009	670-3275-00
A2	670-3271-00			CIRCUIT BD ASSY:SOURCE SW	80009	670-3271-00
A3	670-3272-00			CIRCUIT BD ASSY:COUPLING SW	80009	670-3272-00
A4	670-3270-00			CIRCUIT BD ASSY:TRIG MODE SW	80009	670-3270-00
A5	670-3273-00			CIRCUIT BD ASSY:DELAYED TRIG SW	80009	670-3273-00
A6	-----			(CKT BOARD ASSY:MAIN INTFC) (PART OF 672-0446-XX)		
A7	670-3276-00	B010100	B059999	CIRCUIT BD ASSY:SWEEP LOGIC	80009	670-3276-00
A7	670-3276-01	B060000	B098279	CIRCUIT BD ASSY:SWEEP LOGIC	80009	670-3276-01
A7	670-3276-02	B098280		CIRCUIT BD ASSY:SWEEP LOGIC	80009	670-3276-02
A8	670-3277-00	B010100	B069999	CIRCUIT BD ASSY:MAIN TRIGGER	80009	670-3277-00
A8	670-3277-01	B070000	B094999	CIRCUIT BD ASSY:MAIN TRIGGER 388-3803-01	80009	670-3277-01
A8	670-3277-02	B095000		CIRCUIT BD ASSY:MAIN TRIG	80009	670-3277-02
A9	670-3278-00	B010100	B029999	CIRCUIT BD ASSY:DELAYED TRIGGER	80009	670-3278-00
A9	670-3278-01	B030000	B069999	CIRCUIT BD ASSY:DELAYED TRIG	80009	670-3278-01
A9	670-3278-02	B070000	B096950	CIRCUIT BD ASSY:DELAYED TRIG	80009	670-3278-02
A9	670-3278-03	B096951		CIRCUIT BD ASSY:DELAY TRIGGER	80009	670-3278-03
A12	670-3279-00			CIRCUIT BD ASSY:READOUT	80009	670-3279-00
C2	281-0619-00			CAP,FXD,CER DI:1.2PF,+/-0.1PF,500V	52763	2RDPLZ007 1P20BC
C8	281-0730-00			CAP,FXD,CER DI:10.8PF,1%,500V	52763	2RDPLZ007 10P8LC
C10	281-0609-00			CAP,FXD,CER DI:1PF,+/-0.1PF,500V	52763	2RDPLZ007 1P00BC
C11	281-0617-00			CAP,FXD,CER DI:15PF,10%,200V	52763	2RDPLZ007 15P0KC
C12	283-0003-00			CAP,FXD,CER DI:0.01UF,+80-20%,150V	59821	D103Z40Z5UJDCXC
C17	281-0578-00	B010100	B069999	CAP,FXD,CER DI:18PF,5%,500V	52763	2RDPLZ007 18P0JC
C17	283-0159-00	B070000		CAP,FXD,CER DI:18PF,5%,50V	04222	SR155A180JAA
C18	281-0578-00			CAP,FXD,CER DI:18PF,5%,500V	52763	2RDPLZ007 18P0JC
C20	283-0251-00			CAP,FXD,CER DI:87 PF,5%,100V	04222	3418 100A 870J
C22	283-0005-00	B010100	B069999	CAP,FXD,CER DI:0.01UF,+100-0%,250V	04222	SR303E103ZAA
C22	283-0204-00	B070000		CAP,FXD,CER DI:0.01UF,20%,50V	04222	SR155E103MAA
C24	283-0005-00	B010100	B069999	CAP,FXD,CER DI:0.01UF,+100-0%,250V	04222	SR303E103ZAA
C25	283-0005-00	B010100	B069999	CAP,FXD,CER DI:0.01UF,+100-0%,250V	04222	SR303E103ZAA
C27	283-0005-00	B010100	B069999	CAP,FXD,CER DI:0.01UF,+100-0%,250V	04222	SR303E103ZAA
C34	283-0065-00	B010100	B069999	CAP,FXD,CER DI:0.001UF,5%,100V	59660	0835-591Y5E0102J
C37	283-0010-00			CAP,FXD,CER DI:0.05UF,+80-20%,50V	04222	SR305E503ZAA
C43	281-0551-00			CAP,FXD,CER DI:390PF,10%,500V	52763	2RDPLZ007 390PMO
C44	281-0525-00			CAP,FXD,CER DI:470PF,+/-94PF,500V	52763	2RDPLZ007 470PMO
C46	283-0191-00			CAP,FXD,CER DI:0.022UF,20%,50V	04222	SR205C223MAA
C56	283-0156-00	B030000	B069999	CAP,FXD,CER DI:0.001 UF,+80-20%,200V	05397	C315C102Z2R5CA
C61	283-0141-00	B010100	B069999	CAP,FXD,CER DI:200PF,10%,600V	14193	PD-0321-201K
C64	283-0059-00			CAP,FXD,CER DI:1UF,+80-20%,50V	31433	C330C105M5R5CA
C65	283-0065-00			CAP,FXD,CER DI:0.001UF,5%,100V	59660	0835-591Y5E0102J
C67	283-0103-00	B070000		CAP,FXD,CER DI:180PF,5%,500V	59821	2DDH73L181J
C70	283-0159-00	B070000		CAP,FXD,CER DI:18PF,5%,50V	04222	SR155A180JAA
C79	283-0005-00	B010100	B069999	CAP,FXD,CER DI:0.01UF,+100-0%,250V	04222	SR303E103ZAA
C81	283-0000-00	B070000		CAP,FXD,CER DI:0.001UF,+100-0%,500V	59660	831-610-Y5U0102P
C91	283-0005-00	B010100	B069999	CAP,FXD,CER DI:0.01UF,+100-0%,250V	04222	SR303E103ZAA
C94	283-0005-00	B010100	B063759	CAP,FXD,CER DI:0.01UF,+100-0%,250V (NOMINAL VALUE,SELECTED)	04222	SR303E103ZAA
C94	283-0005-00	B063760		CAP,FXD,CER DI:0.01UF,+100-0%,250V (NOMINAL VALUE SEL.,ADDED WHEN NECESSARY)	04222	SR303E103ZAA
C95	283-0005-00	B010100	B063759	CAP,FXD,CER DI:0.01UF,+100-0%,250V (NOMINAL VALUE,SELECTED)	04222	SR303E103ZAA
C95	283-0005-00	B063760		CAP,FXD,CER DI:0.01UF,+100-0%,250V (NOMINAL VALUE SEL.,ADDED WHEN NECESSARY)	04222	SR303E103ZAA
C122	283-0253-00	B010100	B069999	CAP,FXD,CER DI:0.01UF,10%,100V	04222	15051C103KZT6C
C124	283-0140-00	B010100	B069999	CAP,FXD,CER DI:4.7PF,+/-0.25PF,50V	72982	8101E003A479C
C127	283-0324-00	B010100	B069999	CAP,FXD,CER DI:0.01UF,+80-20%,50V	04222	08055C103ZA2055
C128	283-0000-00	B010100	B069999	CAP,FXD,CER DI:0.001UF,+100-0%,500V	59660	831-610-Y5U0102P

Component No.	Tektronix Part No.	Serial/Assembly No. Effective	Discnt	Name & Description	Mfr. Code	Mfr. Part No.
C140	283-0119-00	B070000		CAP,FXD,CER DI:2200PF,5%,200V	59660	855-XXXY5E0222J
C141	283-0140-00	B010100	B069999	CAP,FXD,CER DI:4.7PF,+/-0.25PF,50V	72982	8101E003A479C
C142	290-0517-00	B010100	B069999	CAP,FXD,ELCTLT:6.8UF,20%,35V	05397	T368B685M035AZ
C147	281-0523-00	B010100	B069999	CAP,FXD,CER DI:100PF,20%,350V	52763	2RDPLZ007 100PMU
C151	283-0032-00	B010100	B069999	CAP,FXD,CER DI:470PF,5%,500V	59660	831-000-Z5E0471J
C152	290-0517-00	B010100	B069999	CAP,FXD,ELCTLT:6.8UF,20%,35V	05397	T368B685M035AZ
C153	281-0525-00	B070000		CAP,FXD,CER DI:470PF,+/-94PF,500V	52763	2RDPLZ007 470PMO
C162	283-0000-00	B010100	B062792	CAP,FXD,CER DI:0.001UF,+100-0%,500V	59660	831-610-Y5U0102P
C162	281-0786-00	B070000		CAP,FXD,CER DI:150PF,10%,100V	04222	MA101A151KAA
C163	283-0204-00	B070000		CAP,FXD,CER DI:0.01UF,20%,50V	04222	SR155E103MAA
C176	283-0318-00	B010100	B069999	CAP,FXD,CER DI:10PF,+/-1PF,100V	04222	ULA151A100K2
C190	283-0000-00	B070000		CAP,FXD,CER DI:0.001UF,+100-0%,500V	59660	831-610-Y5U0102P
C191	283-0177-00			CAP,FXD,CER DI:1UF,+80-20%,25V	04222	SR302E105ZAATR
C192	283-0177-00	B070000		CAP,FXD,CER DI:1UF,+80-20%,25V	04222	SR302E105ZAATR
C193	283-0177-00	B010100	B069999	CAP,FXD,CER DI:1UF,+80-20%,25V	04222	SR302E105ZAATR
C193	283-0204-00	B070000		CAP,FXD,CER DI:0.01UF,20%,50V	04222	SR155E103MAA
C194	283-0024-00	B070000		CAP,FXD,CER DI:0.1UF,+80-20%,50V	04222	SR215C104MAA
C195	283-0177-00	B010100	B069999	CAP,FXD,CER DI:1UF,+80-20%,25V	04222	SR302E105ZAATR
C196	283-0177-00	B070000		CAP,FXD,CER DI:1UF,+80-20%,25V	04222	SR302E105ZAATR
C197	283-0204-00	B070000		CAP,FXD,CER DI:0.01UF,20%,50V	04222	SR155E103MAA
C198	283-0204-00	B070000		CAP,FXD,CER DI:0.01UF,20%,50V	04222	SR155E103MAA
C202	281-0619-00			CAP,FXD,CER DI:1.2PF,+/-0.1PF,500V	52763	2RDPLZ007 1P20BC
C211	281-0617-00			CAP,FXD,CER DI:15PF,10%,200V	52763	2RDPLZ007 15POKC
C212	283-0005-00			CAP,FXD,CER DI:0.01UF,+100-0%,250V	04222	SR303E103ZAA
C214	283-0140-00			CAP,FXD,CER DI:4.7PF,+/-0.25PF,50V	72982	8101E003A479C
C220	283-0059-00			CAP,FXD,CER DI:1UF,+80-20%,50V	31433	C330C105M5R5CA
C221	283-0251-00	B070000		CAP,FXD,CER DI:87 PF,5%,100V	04222	3418 100A 870J
C222	283-0005-00	B070000	B096950	CAP,FXD,CER DI:0.01UF,+100-0%,250V	04222	SR303E103ZAA
C222	281-0773-00	B096951		CAP,FXD,CER DI:0.01UF,10%,100V	04222	MA201C103KAA
C224	283-0204-00	B010100	B069999	CAP,FXD,CER DI:0.01UF,20%,50V	04222	SR155E103MAA
C225	283-0005-00	B010100	B069999	CAP,FXD,CER DI:0.01UF,+100-0%,250V	04222	SR303E103ZAA
C226	283-0251-00	B010100	B069999	CAP,FXD,CER DI:87 PF,5%,100V	04222	3418 100A 870J
C231	283-0005-00	B010100	B069999	CAP,FXD,CER DI:0.01UF,+100-0%,250V	04222	SR303E103ZAA
C233	283-0204-00	B010100	B069999	CAP,FXD,CER DI:0.01UF,20%,50V	04222	SR155E103MAA
C243	283-0103-00	B070000	B096950	CAP,FXD,CER DI:180PF,5%,500V	59821	2DDH73L181J
C243	281-0851-00	B096951		CAP,FXD,CER DI:180PF,5%,100VDC	04222	MA101A181JAA
C246	283-0191-00	B010100	B096950	CAP,FXD,CER DI:0.022UF,20%,50V	04222	SR205C223MAA
C246	281-0774-00	B096951		CAP,FXD,CER DI:0.022MFD,20%,100V	04222	MA201E223MAA
C261	283-0141-00	B010100	B069999	CAP,FXD,CER DI:200PF,10%,600V	14193	PD-0321-201K
C270	283-0159-00	B070000		CAP,FXD,CER DI:18PF,5%,50V	04222	SR155A180JAA
C279	283-0005-00	B010100	B069999	CAP,FXD,CER DI:0.01UF,+100-0%,250V	04222	SR303E103ZAA
C289	283-0005-00	B010100	B069999	CAP,FXD,CER DI:0.01UF,+100-0%,250V	04222	SR303E103ZAA
C291	283-0005-00	B010100	B069999	CAP,FXD,CER DI:0.01UF,+100-0%,250V	04222	SR303E103ZAA
C295	283-0005-00	B010100	B069999	CAP,FXD,CER DI:0.01UF,+100-0%,250V	04222	SR303E103ZAA
C297	283-0005-00	B010100	B069999	CAP,FXD,CER DI:0.01UF,+100-0%,250V	04222	SR303E103ZAA
C321	283-0324-00	B010100	B069999	CAP,FXD,CER DI:0.01UF,+80-20%,50V	04222	08055C103ZA2055
C324	283-0140-00	B010100	B069999	CAP,FXD,CER DI:4.7PF,+/-0.25PF,50V	72982	8101E003A479C
C325	283-0253-00	B010100	B069999	CAP,FXD,CER DI:0.01UF,10%,100V	04222	15051C103KZT6C
C341	283-0140-00	B010100	B069999	CAP,FXD,CER DI:4.7PF,+/-0.25PF,50V	72982	8101E003A479C
C342	290-0517-00	B010100	B069999	CAP,FXD,ELCTLT:6.8UF,20%,35V	05397	T368B685M035AZ
C352	290-0517-00	B010100	B069999	CAP,FXD,ELCTLT:6.8UF,20%,35V	05397	T368B685M035AZ
C373	283-0318-00	B010100	B069999	CAP,FXD,CER DI:10PF,+/-1PF,100V	04222	ULA151A100K2
C385	283-0204-00	B010100	B069999	CAP,FXD,CER DI:0.01UF,20%,50V	04222	SR155E103MAA
C387	281-0550-00	B010100	B029999	CAP,FXD,CER DI:120PF,10%,500V	52763	2RDPLZ007 120PMO
C391	283-0177-00			CAP,FXD,CER DI:1UF,+80-20%,25V	04222	SR302E105ZAATR
C392	283-0005-00	B070000	B096950	CAP,FXD,CER DI:0.01UF,+100-0%,250V	04222	SR303E103ZAA
C392	281-0773-00	B096951		CAP,FXD,CER DI:0.01UF,10%,100V	04222	MA201C103KAA
C393	283-0177-00			CAP,FXD,CER DI:1UF,+80-20%,25V	04222	SR302E105ZAATR

Replaceable Electrical Parts - 7B92A

Component No.	Tektronix Part No.	Serial/Assembly No. Effective	Discnt	Name & Description	Mfr. Code	Mfr. Part No.
C394	283-0204-00	B070000	B096950	CAP, FXD, CER DI: 0.01UF, 20%, 50V	04222	SR155E103MAA
C394	281-0773-00	B096951		CAP, FXD, CER DI: 0.01UF, 10%, 100V	04222	MA201C103KAA
C395	283-0177-00	B010100	B069999	CAP, FXD, CER DI: 1UF, +80-20%, 25V	04222	SR302E105ZAATR
C395	283-0024-00	B070000	B096950	CAP, FXD, CER DI: 0.1UF, +80-20%, 50V	04222	SR215C104MAA
C395	281-0775-00	B096951		CAP, FXD, CER DI: 0.1UF, 20%, 50V	04222	MA205E104MAA
C397	283-0177-00	B070000		CAP, FXD, CER DI: 1UF, +80-20%, 25V	04222	SR302E105ZAATR
C398	283-0005-00	B070000	B096950	CAP, FXD, CER DI: 0.01UF, +100-0%, 250V	04222	SR303E103ZAA
C398	281-0773-00	B096951		CAP, FXD, CER DI: 0.01UF, 10%, 100V	04222	MA201C103KAA
C411	283-0051-00			CAP, FXD, CER DI: 0.0033UF, 5%, 100V	04222	SR301A332JAA
C415	283-0111-00			CAP, FXD, CER DI: 0.1UF, 20%, 50V	05397	C330C104M5U1CA
C431	283-0003-00			CAP, FXD, CER DI: 0.01UF, +80-20%, 150V	59821	D103Z40Z5UJDCX
C432	285-0889-00			CAP, FXD, PLASTIC: 0.0027UF, 5%, 100V	19396	DU490/74-28221
C438	283-0111-00			CAP, FXD, CER DI: 0.1UF, 20%, 50V	05397	C330C104M5U1CA
C440	281-0153-00			CAP, VAR, AIR DI: 1.7-10PF, 250V	74970	187-0106-055
C441	283-0633-00			CAP, FXD, MICA DI: 77PF, 1%, 100V	00853	D155E770F0
C446	283-0111-00			CAP, FXD, CER DI: 0.1UF, 20%, 50V	05397	C330C104M5U1CA
C448	283-0111-00			CAP, FXD, CER DI: 0.1UF, 20%, 50V	05397	C330C104M5U1CA
C463	283-0047-00	B070000		CAP, FXD, CER DI: 270PF, 5%, 500V	59660	0831604Z5F0271J
C473	283-0111-00	B010100	B059999	CAP, FXD, CER DI: 0.1UF, 20%, 50V	05397	C330C104M5U1CA
C484	283-0648-00			CAP, FXD, MICA DI: 10PF, 5%, 500V	00853	D155C100D0
C489	290-0527-00			CAP, FXD, ELCTLT: 15UF, 20%, 20V	05397	T368B156M020AS
C491	290-0530-00			CAP, FXD, ELCTLT: 68UF, 20%, 6V	56289	196D686X0006KA1
C492	283-0111-00			CAP, FXD, CER DI: 0.1UF, 20%, 50V	05397	C330C104M5U1CA
C493	281-0584-00	B010100	B069999	CAP, FXD, CER DI: 100PF, 5%, 500V	72982	0301000 Y5E0101J
C508	283-0615-00			CAP, FXD, MICA DI: 33PF, 5%, 500V	00853	D155E330J0
C511	283-0051-00			CAP, FXD, CER DI: 0.0033UF, 5%, 100V	04222	SR301A332JAA
C515	283-0111-00			CAP, FXD, CER DI: 0.1UF, 20%, 50V	05397	C330C104M5U1CA
C531	290-0523-00			CAP, FXD, ELCTLT: 2.1UF, 20%, 20V	05397	T368A225M020AS
C532	285-0889-00			CAP, FXD, PLASTIC: 0.0027UF, 5%, 100V	19396	DU490/74-28221
C538	283-0111-00			CAP, FXD, CER DI: 0.1UF, 20%, 50V	05397	C330C104M5U1CA
C540	281-0168-00			CAP, VAR, AIR DI: 1.3-5.4PF, 250V	74970	187-0103-005
C546	283-0111-00			CAP, FXD, CER DI: 0.1UF, 20%, 50V	05397	C330C104M5U1CA
C548	283-0111-00			CAP, FXD, CER DI: 0.1UF, 20%, 50V	05397	C330C104M5U1CA
C573	283-0111-00			CAP, FXD, CER DI: 0.1UF, 20%, 50V	05397	C330C104M5U1CA
C607	281-0618-00			CAP, FXD, CER DI: 4.7PF, +/-0.5PF, 500V	52763	2RDPLZ007 4P70DC
C705	295-0172-00			CAP SET, MATCHED: 0.1UF, 10UF, 898PF, MATCHED	80009	295-0172-00
C706	295-0172-00			CAP SET, MATCHED: 0.1UF, 10UF, 898PF, MATCHED	80009	295-0172-00
C707	-----			(PART OF C705)		
C709	285-0598-00			CAP, FXD, PLASTIC: 0.01UF, 5%, 100V	19396	DU490B103J
C710	290-0183-00			CAP, FXD, ELCTLT: 1UF, 10%, 35V	05397	T3228105K035AS
C715	295-0172-00			CAP SET, MATCHED: 0.1UF, 10UF, 898PF, MATCHED	80009	295-0172-00
C716	295-0172-00			CAP SET, MATCHED: 0.1UF, 10UF, 898PF, MATCHED	80009	295-0172-00
C717	-----			(PART OF C715)		
C721	281-0166-00			CAP, VAR, AIR DI: 1.9-15.7 PF, 250V	74970	187-0109-055
C722	283-0647-00			CAP, FXD, MICA DI: 70PF, 1%, 100V	00853	D155E700F0
C750	290-0420-00			CAP, FXD, ELCTLT: 0.68UF, 20%, 75V	05397	T110A684M075AS
C819	281-0504-00			CAP, FXD, CER DI: 10PF, +/-1PF, 500V	54583	TCC20CH2H100FYA
C822	283-0177-00			CAP, FXD, CER DI: 1UF, +80-20%, 25V	04222	SR302E105ZAATR
C825	290-0536-00			CAP, FXD, ELCTLT: 10UF, 20%, 25V TANTALUM	05397	T368B106M025AS
C828	283-0177-00			CAP, FXD, CER DI: 1UF, +80-20%, 25V	04222	SR302E105ZAATR
C830	283-0111-00			CAP, FXD, CER DI: 0.1UF, 20%, 50V	05397	C330C104M5U1CA
C834	283-0728-00			CAP, FXD, MICA DI: 120PF, 1%, 500V	00853	D155F121F0
C835	283-0646-00			CAP, FXD, MICA DI: 170PF, 1%, 100V	00853	D155F171F0
C837	283-0111-00	B010100	B069999	CAP, FXD, CER DI: 0.1UF, 20%, 50V	05397	C330C104M5U1CA
C837	290-0536-00	B070000		CAP, FXD, ELCTLT: 10UF, 20%, 25V TANTALUM	05397	T368B106M025AS
C844	290-0527-00			CAP, FXD, ELCTLT: 15UF, 20%, 20V	05397	T368B156M020AS
C852	283-0644-00			CAP, FXD, MICA DI: 150PF, 1%, 500V	00853	D155F151F0
C874	281-0603-00			CAP, FXD, CER DI: 39PF, 5%, 500V	52763	2RDPLZ007 39POJC

Component No.	Tektronix	Serial/Assembly No.		Name & Description	Mfr.	Mfr. Part No.
	Part No.	Effective	Discnt		Code	
C886	283-0111-00	B010100	B059999	CAP,FXD,CER DI:0.1UF,20%,50V	05397	C330C104M5U1CA
C891	283-0177-00	B010100	B059999	CAP,FXD,CER DI:1UF,+80-20%,25V	04222	SR302E105ZAATR
C891	290-0745-00	B060000		CAP,FXD,ELCTLT:22UF,+50-10%,25V	54473	ECE-A25V22L
C893	283-0177-00	B010100	B059999	CAP,FXD,CER DI:1UF,+80-20%,25V	04222	SR302E105ZAATR
C893	290-0745-00	B060000		CAP,FXD,ELCTLT:22UF,+50-10%,25V	54473	ECE-A25V22L
C895	283-0177-00	B010100	B059999	CAP,FXD,CER DI:1UF,+80-20%,25V	04222	SR302E105ZAATR
C895	290-0745-00	B060000		CAP,FXD,ELCTLT:22UF,+50-10%,25V	54473	ECE-A25V22L
C905	283-0111-00			CAP,FXD,CER DI:0.1UF,20%,50V	05397	C330C104M5U1CA
C915	283-0111-00			CAP,FXD,CER DI:0.1UF,20%,50V	05397	C330C104M5U1CA
C935	283-0003-00			CAP,FXD,CER DI:0.01UF,+80-20%,150V	59821	D103Z40Z5UJDCFX
C938	281-0540-00			CAP,FXD,CER DI:51PF,5%,500V	59660	301-000U2J0510J
C942	283-0065-00			CAP,FXD,CER DI:0.001UF,5%,100V	59660	0835-591Y5E0102J
C944	283-0065-00			CAP,FXD,CER DI:0.001UF,5%,100V	59660	0835-591Y5E0102J
C952	281-0578-00			CAP,FXD,CER DI:18PF,5%,500V	52763	2RDXPLZ007 18PQJC
C954	283-0065-00			CAP,FXD,CER DI:0.001UF,5%,100V	59660	0835-591Y5E0102J
C971	283-0178-00			CAP,FXD,CER DI:0.1UF,20%,100V	05397	C330C104Z1U1CA
C972	290-0527-00			CAP,FXD,ELCTLT:15UF,20%,20V	05397	T368B156M020AS
C973	290-0530-00			CAP,FXD,ELCTLT:68UF,20%,6V	56289	196D686X0006KA1
C974	283-0111-00			CAP,FXD,CER DI:0.1UF,20%,50V	05397	C330C104M5U1CA
C975	283-0111-00			CAP,FXD,CER DI:0.1UF,20%,50V	05397	C330C104M5U1CA
C976	290-0527-00			CAP,FXD,ELCTLT:15UF,20%,20V	05397	T368B156M020AS
C978	283-0111-00			CAP,FXD,CER DI:0.1UF,20%,50V	05397	C330C104M5U1CA
CR6	152-0141-02			SEMICON DVC,DI:SW,SI,30V,150MA,30V,DO-35	03508	DA2527 (1N4152)
CR7	152-0141-02			SEMICON DVC,DI:SW,SI,30V,150MA,30V,DO-35	03508	DA2527 (1N4152)
CR21	152-0141-02			SEMICON DVC,DI:SW,SI,30V,150MA,30V,DO-35	03508	DA2527 (1N4152)
CR91	152-0141-02	B010100	B069999	SEMICON DVC,DI:SW,SI,30V,150MA,30V,DO-35	03508	DA2527 (1N4152)
CR105	152-0141-02	B010100	B069999	SEMICON DVC,DI:SW,SI,30V,150MA,30V,DO-35	03508	DA2527 (1N4152)
CR113	152-0141-02	B010100	B069999	SEMICON DVC,DI:SW,SI,30V,150MA,30V,DO-35	03508	DA2527 (1N4152)
CR114	152-0177-02	B010100	B069999	SEMICON DVC,DI:TNL,GE,10MA,2PF,DO-17	03508	SMTD998
CR131	152-0141-02	B010100	B069999	SEMICON DVC,DI:SW,SI,30V,150MA,30V,DO-35	03508	DA2527 (1N4152)
CR142	152-0141-02	B070000		SEMICON DVC,DI:SW,SI,30V,150MA,30V,DO-35	03508	DA2527 (1N4152)
CR145	152-0141-02	B070000		SEMICON DVC,DI:SW,SI,30V,150MA,30V,DO-35	03508	DA2527 (1N4152)
CR151	152-0141-02	B070000		SEMICON DVC,DI:SW,SI,30V,150MA,30V,DO-35	03508	DA2527 (1N4152)
CR172	152-0177-02	B010100	B069999	SEMICON DVC,DI:TNL,GE,10MA,2PF,DO-17	03508	SMTD998
CR176	152-0177-02	B010100	B069999	SEMICON DVC,DI:TNL,GE,10MA,2PF,DO-17	03508	SMTD998
CR221	152-0141-02			SEMICON DVC,DI:SW,SI,30V,150MA,30V,DO-35	03508	DA2527 (1N4152)
CR289	152-0141-02	B010100	B069999	SEMICON DVC,DI:SW,SI,30V,150MA,30V,DO-35	03508	DA2527 (1N4152)
CR291	152-0141-02	B010100	B069999	SEMICON DVC,DI:SW,SI,30V,150MA,30V,DO-35	03508	DA2527 (1N4152)
CR313	152-0141-02	B010100	B069999	SEMICON DVC,DI:SW,SI,30V,150MA,30V,DO-35	03508	DA2527 (1N4152)
CR314	152-0177-02	B010100	B069999	SEMICON DVC,DI:TNL,GE,10MA,2PF,DO-17	03508	SMTD998
CR335	152-0141-02	B010100	B069999	SEMICON DVC,DI:SW,SI,30V,150MA,30V,DO-35	03508	DA2527 (1N4152)
CR336	152-0141-02	B010100	B069999	SEMICON DVC,DI:SW,SI,30V,150MA,30V,DO-35	03508	DA2527 (1N4152)
CR337	152-0141-02	B010100	B069999	SEMICON DVC,DI:SW,SI,30V,150MA,30V,DO-35	03508	DA2527 (1N4152)
CR338	152-0141-02	B010100	B069999	SEMICON DVC,DI:SW,SI,30V,150MA,30V,DO-35	03508	DA2527 (1N4152)
CR342	152-0141-02	B070000		SEMICON DVC,DI:SW,SI,30V,150MA,30V,DO-35	03508	DA2527 (1N4152)
CR362	152-0322-00	B070000		SEMICON DVC,DI:SCHOTTKY BARR,SI,15V,DO-35	50434	5082-2672
CR372	152-0177-02	B010100	B069999	SEMICON DVC,DI:TNL,GE,10MA,2PF,DO-17	03508	SMTD998
CR376	152-0177-02	B010100	B069999	SEMICON DVC,DI:TNL,GE,10MA,2PF,DO-17	03508	SMTD998
CR381	152-0153-00			SEMICON DVC,DI:SW,SI,10V,50MA,.DO-7	07263	FD7003
CR410	152-0141-02			SEMICON DVC,DI:SW,SI,30V,150MA,30V,DO-35	03508	DA2527 (1N4152)
CR429	152-0141-02			SEMICON DVC,DI:SW,SI,30V,150MA,30V,DO-35	03508	DA2527 (1N4152)
CR433	152-0141-02			SEMICON DVC,DI:SW,SI,30V,150MA,30V,DO-35	03508	DA2527 (1N4152)
CR434	152-0153-00			SEMICON DVC,DI:SW,SI,10V,50MA,.DO-7	07263	FD7003
CR443	150-1004-00	B010100	063027	LT EMITTING DIO:RED,15MA	08806	SSL-12
CR443	150-1040-00	B062028		LT EMITTING DIO:RED,690NM,40MA MAX	50347	LLL-7A
CR444	152-0153-00			SEMICON DVC,DI:SW,SI,10V,50MA,.DO-7	07263	FD7003
CR447	152-0141-02			SEMICON DVC,DI:SW,SI,30V,150MA,30V,DO-35	03508	DA2527 (1N4152)
CR456	152-0141-02			SEMICON DVC,DI:SW,SI,30V,150MA,30V,DO-35	03508	DA2527 (1N4152)

Replaceable Electrical Parts - 7B92A

Component No.	Tektronix Part No.	Serial/Assembly No.		Name & Description	Mfr. Code	Mfr. Part No.
		Effective	Discont			
CR471	152-0141-02			SEMICON DVC,DI:SW,SI,30V,150MA,30V,DO-35	03508	DA2527 (1N4152)
CR472	152-0322-00			SEMICON DVC,DI:SCHOTTKY BARR,SI,15V,DO-35	50434	5082-2672
CR474	152-0153-00	B010100	B059999	SEMICON DVC,DI:SW,SI,10V,50MA,.DO-7	07263	FD7003
CR474	152-0141-02	B060000		SEMICON DVC,DI:SW,SI,30V,150MA,30V,DO-35	03508	DA2527 (1N4152)
CR483	152-0182-00			SEMICON DVC,DI:TNL,GE,10MA,50PF,DO-17	80009	152-0182-00
CR488	152-0141-02			SEMICON DVC,DI:SW,SI,30V,150MA,30V,DO-35	03508	DA2527 (1N4152)
CR493	152-0182-00	B010100	B069999	SEMICON DVC,DI:TNL,GE,10MA,50PF,DO-17	80009	152-0182-00
CR498	152-0141-02			SEMICON DVC,DI:SW,SI,30V,150MA,30V,DO-35	03508	DA2527 (1N4152)
CR508	152-0153-00			SEMICON DVC,DI:SW,SI,10V,50MA,.DO-7	07263	FD7003
CR510	152-0075-00	B010100	B097285	SEMICON DVC,DI:SW,GE,22V,80MW,DO-7	14433	G866
CR510	152-0141-02	B097286		SEMICON DVC,DI:SW,SI,30V,150MA,30V,DO-35	03508	DA2527 (1N4152)
CR529	152-0141-02			SEMICON DVC,DI:SW,SI,30V,150MA,30V,DO-35	03508	DA2527 (1N4152)
CR534	152-0153-00			SEMICON DVC,DI:SW,SI,10V,50MA,.DO-7	07263	FD7003
CR543	152-0153-00			SEMICON DVC,DI:SW,SI,10V,50MA,.DO-7	07263	FD7003
CR547	152-0141-02			SEMICON DVC,DI:SW,SI,30V,150MA,30V,DO-35	03508	DA2527 (1N4152)
CR571	152-0141-02			SEMICON DVC,DI:SW,SI,30V,150MA,30V,DO-35	03508	DA2527 (1N4152)
CR572	152-0322-00			SEMICON DVC,DI:SCHOTTKY BARR,SI,15V,DO-35	50434	5082-2672
CR574	152-0153-00			SEMICON DVC,DI:SW,SI,10V,50MA,.DO-7	07263	FD7003
CR602	152-0141-02			SEMICON DVC,DI:SW,SI,30V,150MA,30V,DO-35	03508	DA2527 (1N4152)
CR606	152-0141-02			SEMICON DVC,DI:SW,SI,30V,150MA,30V,DO-35	03508	DA2527 (1N4152)
CR611	152-0141-02			SEMICON DVC,DI:SW,SI,30V,150MA,30V,DO-35	03508	DA2527 (1N4152)
CR612	152-0141-02			SEMICON DVC,DI:SW,SI,30V,150MA,30V,DO-35	03508	DA2527 (1N4152)
CR613	152-0141-02			SEMICON DVC,DI:SW,SI,30V,150MA,30V,DO-35	03508	DA2527 (1N4152)
CR616	152-0141-02			SEMICON DVC,DI:SW,SI,30V,150MA,30V,DO-35	03508	DA2527 (1N4152)
CR617	152-0141-02			SEMICON DVC,DI:SW,SI,30V,150MA,30V,DO-35	03508	DA2527 (1N4152)
CR618	152-0141-02			SEMICON DVC,DI:SW,SI,30V,150MA,30V,DO-35	03508	DA2527 (1N4152)
CR633	152-0141-02	B060000		SEMICON DVC,DI:SW,SI,30V,150MA,30V,DO-35	03508	DA2527 (1N4152)
CR634	152-0141-02	B060000		SEMICON DVC,DI:SW,SI,30V,150MA,30V,DO-35	03508	DA2527 (1N4152)
CR751	152-0141-02			SEMICON DVC,DI:SW,SI,30V,150MA,30V,DO-35	03508	DA2527 (1N4152)
CR752	152-0141-02			SEMICON DVC,DI:SW,SI,30V,150MA,30V,DO-35	03508	DA2527 (1N4152)
CR753	152-0141-02			SEMICON DVC,DI:SW,SI,30V,150MA,30V,DO-35	03508	DA2527 (1N4152)
CR755	152-0141-02			SEMICON DVC,DI:SW,SI,30V,150MA,30V,DO-35	03508	DA2527 (1N4152)
CR758	152-0141-02			SEMICON DVC,DI:SW,SI,30V,150MA,30V,DO-35	03508	DA2527 (1N4152)
CR761	152-0141-02			SEMICON DVC,DI:SW,SI,30V,150MA,30V,DO-35	03508	DA2527 (1N4152)
CR762	152-0141-02			SEMICON DVC,DI:SW,SI,30V,150MA,30V,DO-35	03508	DA2527 (1N4152)
CR763	152-0141-02			SEMICON DVC,DI:SW,SI,30V,150MA,30V,DO-35	03508	DA2527 (1N4152)
CR764	152-0141-02			SEMICON DVC,DI:SW,SI,30V,150MA,30V,DO-35	03508	DA2527 (1N4152)
CR765	152-0141-02			SEMICON DVC,DI:SW,SI,30V,150MA,30V,DO-35	03508	DA2527 (1N4152)
CR766	152-0141-02			SEMICON DVC,DI:SW,SI,30V,150MA,30V,DO-35	03508	DA2527 (1N4152)
CR771	152-0141-02			SEMICON DVC,DI:SW,SI,30V,150MA,30V,DO-35	03508	DA2527 (1N4152)
CR772	152-0141-02			SEMICON DVC,DI:SW,SI,30V,150MA,30V,DO-35	03508	DA2527 (1N4152)
CR773	152-0141-02			SEMICON DVC,DI:SW,SI,30V,150MA,30V,DO-35	03508	DA2527 (1N4152)
CR774	152-0141-02			SEMICON DVC,DI:SW,SI,30V,150MA,30V,DO-35	03508	DA2527 (1N4152)
CR775	152-0141-02			SEMICON DVC,DI:SW,SI,30V,150MA,30V,DO-35	03508	DA2527 (1N4152)
CR776	152-0141-02			SEMICON DVC,DI:SW,SI,30V,150MA,30V,DO-35	03508	DA2527 (1N4152)
CR781	152-0141-02			SEMICON DVC,DI:SW,SI,30V,150MA,30V,DO-35	03508	DA2527 (1N4152)
CR785	152-0141-02			SEMICON DVC,DI:SW,SI,30V,150MA,30V,DO-35	03508	DA2527 (1N4152)
CR786	152-0141-02			SEMICON DVC,DI:SW,SI,30V,150MA,30V,DO-35	03508	DA2527 (1N4152)
CR799	152-0141-02			SEMICON DVC,DI:SW,SI,30V,150MA,30V,DO-35	03508	DA2527 (1N4152)
CR802	152-0141-02			SEMICON DVC,DI:SW,SI,30V,150MA,30V,DO-35	03508	DA2527 (1N4152)
CR806	152-0141-02			SEMICON DVC,DI:SW,SI,30V,150MA,30V,DO-35	03508	DA2527 (1N4152)
CR811	152-0141-02			SEMICON DVC,DI:SW,SI,30V,150MA,30V,DO-35	03508	DA2527 (1N4152)
CR824	152-0141-02			SEMICON DVC,DI:SW,SI,30V,150MA,30V,DO-35	03508	DA2527 (1N4152)
CR825	152-0141-02			SEMICON DVC,DI:SW,SI,30V,150MA,30V,DO-35	03508	DA2527 (1N4152)
CR826	152-0141-02			SEMICON DVC,DI:SW,SI,30V,150MA,30V,DO-35	03508	DA2527 (1N4152)
CR876	152-0141-02			SEMICON DVC,DI:SW,SI,30V,150MA,30V,DO-35	03508	DA2527 (1N4152)
CR882	152-0153-00	B010100	B059999	SEMICON DVC,DI:SW,SI,10V,50MA,.DO-7	07263	FD7003
CR882	152-0141-02	B060000		SEMICON DVC,DI:SW,SI,30V,150MA,30V,DO-35	03508	DA2527 (1N4152)

Component No.	Tektronix	Serial/Assembly No.		Name & Description	Mfr:	Mfr. Part No.
	Part No.	Effective	Discont		Code	
CR892	152-0075-00	B010100	B097285	SEMICON DVC,DI:SW,GE,22V,80MW,DO-7	14433	G866
CR892	152-0322-00	B097286		SEMICON DVC,DI:SCHOTTKY BARR,SI,15V,DO-35	50434	5082-2672
CR894	152-0141-02			SEMICON DVC,DI:SW,SI,30V,150MA,30V,DO-35	03508	DA2527 (1N4152)
CR894	152-0141-02			SEMICON DVC,DI:SW,SI,30V,150MA,30V,DO-35	03508	DA2527 (1N4152)
CR922	152-0141-02			SEMICON DVC,DI:SW,SI,30V,150MA,30V,DO-35	03508	DA2527 (1N4152)
CR930	152-0141-02			SEMICON DVC,DI:SW,SI,30V,150MA,30V,DO-35	03508	DA2527 (1N4152)
CR932	152-0141-02			SEMICON DVC,DI:SW,SI,30V,150MA,30V,DO-35	03508	DA2527 (1N4152)
CR934	152-0141-02			SEMICON DVC,DI:SW,SI,30V,150MA,30V,DO-35	03508	DA2527 (1N4152)
CR938	152-0141-02			SEMICON DVC,DI:SW,SI,30V,150MA,30V,DO-35	03508	DA2527 (1N4152)
CR963	152-0141-02			SEMICON DVC,DI:SW,SI,30V,150MA,30V,DO-35	03508	DA2527 (1N4152)
DS10	150-0048-01			LAMP, INCAND:5V,0.06A,#683,AGED & SEL	58854	683AS15
DS20	150-0048-01			LAMP, INCAND:5V,0.06A,#683,AGED & SEL	58854	683AS15
DS100	150-0048-01			LAMP, INCAND:5V,0.06A,#683,AGED & SEL	58854	683AS15
DS820	150-0048-01			LAMP, INCAND:5V,0.06A,#683,AGED & SEL	58854	683AS15
DS845	150-0048-01			LAMP, INCAND:5V,0.06A,#683,AGED & SEL	58854	683AS15
K6	108-0358-00			COIL, REED SW:12VDC,13.2MA,SINGLE REED	80009	108-0358-00
L4	108-0170-01			COIL, RF:FIXED,360NH	TK2042	ORDER BY DESC
L46	108-0682-00	B070000		COIL, RF:FIXED,61NH	80009	108-0682-00
L61	276-0543-00			SHLD BEAD,ELEK:FERRITE	80009	276-0543-00
L62	108-0331-00	B010100	B069999	COIL, RF:FIXED,758NH	TK1345	108-0331-00
L82	108-0440-00	B070000		COIL, RF:FIXED,8UH	80009	108-0440-00
L84	108-0331-00	B010100	B069999	COIL, RF:FIXED,758NH	TK1345	108-0331-00
L86	108-0440-00	B070000		COIL, RF:FIXED,8UH	80009	108-0440-00
L91	108-0331-00	B010100	B069999	COIL, RF:FIXED,758NH	TK1345	108-0331-00
L101	108-0331-00	B010100	B069999	COIL, RF:FIXED,758NH	TK1345	108-0331-00
L112	276-0543-02			SHLD BEAD,ELEK:FERRITE	28733	ORDER BY DESC
L204	108-0170-01			COIL, RF:FIXED,360NH	TK2042	ORDER BY DESC
L246	108-0682-00	B070000		COIL, RF:FIXED,61NH	80009	108-0682-00
L261	276-0543-02	B010100	B069999	SHLD BEAD,ELEK:FERRITE	28733	ORDER BY DESC
L262	108-0331-00	B010100	B069999	COIL, RF:FIXED,758NH	TK1345	108-0331-00
L284	108-0331-00	B010100	B069999	COIL, RF:FIXED,758NH	TK1345	108-0331-00
L291	108-0331-00	B010100	B069999	COIL, RF:FIXED,758NH	TK1345	108-0331-00
L301	108-0331-00	B010100	B069999	COIL, RF:FIXED,758NH	TK1345	108-0331-00
L312	276-0543-02	B010100	B069999	SHLD BEAD,ELEK:FERRITE	28733	ORDER BY DESC
L382	108-0474-00	B030000	B069999	COIL, RF:FIXED,2UH	80009	108-0474-00
L462	276-0507-00	B030000		SHLD BEAD,ELEK:FERRITE	02114	56-590-65B/3B
L493	276-0507-00	B030000	B069999	SHLD BEAD,ELEK:FERRITE	02114	56-590-65B/3B
L558	108-0170-01			COIL, RF:FIXED,360NH	TK2042	ORDER BY DESC
L574	276-0507-00			SHLD BEAD,ELEK:FERRITE	02114	56-590-65B/3B
L938	276-0507-00			SHLD BEAD,ELEK:FERRITE	02114	56-590-65B/3B
LR72	108-0298-00	B070000		COIL, RF:FIXED,230NH	TK1345	108-0298-00
LR248	108-0298-00	B070000		COIL, RF:FIXED,230NH	TK1345	108-0298-00
LR482	108-0408-00			COIL, RF:FIXED,91NH	TK1345	108-0408-00
LR891	108-0543-00			COIL, RF:FIXED,1.1UH	TK1345	108-0543-00
LR893	108-0543-00			COIL, RF:FIXED,1.1UH	TK1345	108-0543-00
LR895	108-0543-00			COIL, RF:FIXED,1.1UH	TK1345	108-0543-00
LR971	108-0537-00			COIL, RF:FIXED,200UH	80009	108-0537-00
LR972	108-0537-00			COIL, RF:FIXED,200UH	80009	108-0537-00
LR973	108-0537-00			COIL, RF:FIXED,200UH	80009	108-0537-00
LR976	108-0537-00			COIL, RF:FIXED,200UH	80009	108-0537-00
LR981	108-0543-00			COIL, RF:FIXED,1.1UH	TK1345	108-0543-00
LR982	108-0543-00			COIL, RF:FIXED,1.1UH	TK1345	108-0543-00
LR983	108-0543-00			COIL, RF:FIXED,1.1UH	TK1345	108-0543-00
LR985	108-0543-00			COIL, RF:FIXED,1.1UH	TK1345	108-0543-00
LR986	108-0543-00			COIL, RF:FIXED,1.1UH	TK1345	108-0543-00
LR987	108-0543-00			COIL, RF:FIXED,1.1UH	TK1345	108-0543-00
Q22	151-1011-00			TRANSISTOR:FE,N CHAN,SI,DUAL,TO-71	04713	SFD1011
Q24	151-0333-00			TRANSISTOR:SELECTED	04713	SPS1752

Replaceable Electrical Parts - 7B92A

Component No.	Tektronix Part No.	Serial/Assembly No. Effective	Discont	Name & Description	Mfr. Code	Mfr. Part No.
Q52	151-0190-00	B010100	B069999	TRANSISTOR:NPN,SI,TO-92	80009	151-0190-00
Q56	151-0188-00	B010100	B069999	TRANSISTOR:PNP,SI,TO-92	80009	151-0188-00
Q58	151-0188-00	B010100	B069999	TRANSISTOR:PNP,SI,TO-92	80009	151-0188-00
Q72	151-0192-00	B010100	B069999	TRANSISTOR:SELECTED	04713	SPS8801
Q74	151-0192-00	B010100	B069999	TRANSISTOR:SELECTED	04713	SPS8801
Q82	151-0190-00	B010100	B069999	TRANSISTOR:NPN,SI,TO-92	80009	151-0190-00
Q82	151-0192-00	B070000		TRANSISTOR:SELECTED	04713	SPS8801
Q84	151-0190-00	B010100	B069999	TRANSISTOR:NPN,SI,TO-92	80009	151-0190-00
Q86	151-0192-00	B070000		TRANSISTOR:SELECTED	04713	SPS8801
Q94	151-0190-00	B070000		TRANSISTOR:NPN,SI,TO-92	80009	151-0190-00
Q96	151-0188-00	B070000		TRANSISTOR:PNP,SI,TO-92	80009	151-0188-00
Q98	151-0188-00	B070000		TRANSISTOR:PNP,SI,TO-92	80009	151-0188-00
Q102	151-0190-00	B070000		TRANSISTOR:NPN,SI,TO-92	80009	151-0190-00
Q104	151-0325-00	B010100	B069999	TRANSISTOR:PNP,SI,TO-92,SEL	80009	151-0325-00
Q106	151-0190-00	B070000		TRANSISTOR:NPN,SI,TO-92	80009	151-0190-00
Q109	151-0192-00	B070000		TRANSISTOR:SELECTED	04713	SPS8801
Q112	151-0362-00	B010100	B069999	TRANSISTOR:PNP,SI,U-43	04713	SMT1105
Q122	151-0192-00	B010100	B069999	TRANSISTOR:SELECTED	04713	SPS8801
Q132	151-0188-00	B010100	B069999	TRANSISTOR:PNP,SI,TO-92	80009	151-0188-00
Q138	151-1005-00	B070000		TRANSISTOR:FET,N-CHAN,SI,TO-106	04713	SPF685
Q142	151-0190-00	B070000		TRANSISTOR:NPN,SI,TO-92	80009	151-0190-00
Q146	151-0190-00	B070000		TRANSISTOR:NPN,SI,TO-92	80009	151-0190-00
Q148	151-0223-00	B010100	B069999	TRANSISTOR:NPN,SI,TO-92	04713	SPS8026
Q151	151-0221-00	B010100	B069999	TRANSISTOR:PNP,SI,TO-92	80009	151-0221-00
Q152	151-0325-00	B070000	B079999	TRANSISTOR:PNP,SI,TO-92,SEL	80009	151-0325-00
Q152	151-0221-00	B080000		TRANSISTOR:PNP,SI,TO-92	80009	151-0221-00
Q158	151-0223-00	B010100	B069999	TRANSISTOR:NPN,SI,TO-92	04713	SPS8026
Q162	151-0188-00	B010100	B069999	TRANSISTOR:PNP,SI,TO-92	80009	151-0188-00
Q162	151-0427-00	B070000		TRANSISTOR:NPN,SI,TO-92	07263	S39287
Q164	151-0188-00	B010100	B069999	TRANSISTOR:PNP,SI,TO-92	80009	151-0188-00
Q174	151-0190-00	B070000		TRANSISTOR:NPN,SI,TO-92	80009	151-0190-00
Q222	151-1011-00			TRANSISTOR:FE,N CHAN,SI,DUAL,TO-71	04713	SFD1011
Q224	151-0333-00			TRANSISTOR:SELECTED	04713	SPS1752
Q256	151-0190-00	B010100	B069999	TRANSISTOR:NPN,SI,TO-92	80009	151-0190-00
Q264	151-0190-00	B070000		TRANSISTOR:NPN,SI,TO-92	80009	151-0190-00
Q312	151-0362-00	B010100	B069999	TRANSISTOR:PNP,SI,U-43	04713	SMT1105
Q328	151-0190-00	B070000		TRANSISTOR:NPN,SI,TO-92	80009	151-0190-00
Q332	151-0221-00	B010100	B069999	TRANSISTOR:PNP,SI,TO-92	80009	151-0221-00
Q334	151-0192-00	B010100	B069999	TRANSISTOR:SELECTED	04713	SPS8801
Q342	151-0427-00	B070000		TRANSISTOR:NPN,SI,TO-92	07263	S39287
Q346	151-0427-00	B070000		TRANSISTOR:NPN,SI,TO-92	07263	S39287
Q348	151-0223-00	B010100	B069999	TRANSISTOR:NPN,SI,TO-92	04713	SPS8026
Q358	151-0223-00	B010100	B069999	TRANSISTOR:NPN,SI,TO-92	04713	SPS8026
Q362	151-0438-00	B070000		TRANSISTOR:PNP,SI,AMPLIFIER,625 MA	80009	151-0438-00
Q366	151-0438-00	B070000		TRANSISTOR:PNP,SI,AMPLIFIER,625 MA	80009	151-0438-00
Q382	151-0367-00	B010100	B069999	TRANSISTOR:NPN,SI,X-55	04713	SPS 8811
Q385	151-0367-00	B010100	B069999	TRANSISTOR:NPN,SI,X-55	04713	SPS 8811
Q387	151-0190-00	B010100	B029999	TRANSISTOR:NPN,SI,TO-92	80009	151-0190-00
Q402	151-0325-00	B010100	B079999	TRANSISTOR:PNP,SI,TO-92,SEL	80009	151-0325-00
Q402	151-0221-00	B080000		TRANSISTOR:PNP,SI,TO-92	80009	151-0221-00
Q404	151-0325-00	B010100	B079999	TRANSISTOR:PNP,SI,TO-92,SEL	80009	151-0325-00
Q404	151-0221-00	B080000		TRANSISTOR:PNP,SI,TO-92	80009	151-0221-00
Q410	151-0367-00			TRANSISTOR:NPN,SI,X-55	04713	SPS 8811
Q412	151-0367-00			TRANSISTOR:NPN,SI,X-55	04713	SPS 8811
Q420	151-0236-00			TRANSISTOR:NPN,SI,DUAL,TO-77	32293	ITS1074
Q430	151-0220-00			TRANSISTOR:PNP,SI,TO-92	80009	151-0220-00
Q436	151-0410-00			TRANSISTOR:PNP,SI,TO-92	04713	SPS6765
Q446	151-1036-00			TRANSISTOR:FET,N-CHAN,SI,TO-71	80009	151-1036-00

Component No.	Tektronix Part No.	Serial/Assembly No. Effective	Dscont	Name & Description	Mfr. Code	Mfr. Part No.
Q450	151-0427-00			TRANSISTOR: NPN, SI, TO-92	07263	S39287
Q456	151-0325-00	B010100	B079999	TRANSISTOR: PNP, SI, TO-92, SEL	80009	151-0325-00
Q456	151-0221-00	B080000	B098279	TRANSISTOR: PNP, SI, TO-92	80009	151-0221-00
Q456	151-0220-00	B098280		TRANSISTOR: PNP, SI, TO-92	80009	151-0220-00
Q458	151-0220-00			TRANSISTOR: PNP, SI, TO-92	80009	151-0220-00
Q462	151-0325-00	B010100	B079999	TRANSISTOR: PNP, SI, TO-92, SEL	80009	151-0325-00
Q462	151-0221-00	B080000		TRANSISTOR: PNP, SI, TO-92	80009	151-0221-00
Q464	151-0325-00	B010100	B079999	TRANSISTOR: PNP, SI, TO-92, SEL	80009	151-0325-00
Q464	151-0221-00	B080000		TRANSISTOR: PNP, SI, TO-92	80009	151-0221-00
Q468	151-0367-00			TRANSISTOR: NPN, SI, X-55	04713	SPS 8811
Q472	151-0223-00			TRANSISTOR: NPN, SI, TO-92	04713	SPS8026
Q474	151-0367-00			TRANSISTOR: NPN, SI, X-55	04713	SPS 8811
Q482	151-0354-00			TRANSISTOR: PNP, SI, TO-78	32293	ITS-1200-A
Q486	151-0410-00			TRANSISTOR: PNP, SI, TO-92	04713	SPS6765
Q492	151-0271-00			TRANSISTOR: PNP, SI, TO-92	04713	SPS8236
Q493	151-0271-00			TRANSISTOR: PNP, SI, TO-92	04713	SPS8236
Q494	151-0410-00			TRANSISTOR: PNP, SI, TO-92	04713	SPS6765
Q502	151-0325-00	B010100	B069999	TRANSISTOR: PNP, SI, TO-92, SEL	80009	151-0325-00
Q502	151-0369-00	B070000		TRANSISTOR: PNP, SI, X-55	04713	SPS8273
Q504	151-0325-00	B010100	B069999	TRANSISTOR: PNP, SI, TO-92, SEL	80009	151-0325-00
Q504	151-0369-00	B070000		TRANSISTOR: PNP, SI, X-55	04713	SPS8273
Q510	151-0367-00			TRANSISTOR: NPN, SI, X-55	04713	SPS 8811
Q512	151-0367-00			TRANSISTOR: NPN, SI, X-55	04713	SPS 8811
Q520	151-0333-00			TRANSISTOR: SELECTED	04713	SPS1752
Q522	151-0333-00			TRANSISTOR: SELECTED	04713	SPS1752
Q530	151-0220-00			TRANSISTOR: PNP, SI, TO-92	80009	151-0220-00
Q536	151-0410-00			TRANSISTOR: PNP, SI, TO-92	04713	SPS6765
Q546	151-1036-00			TRANSISTOR: FET, N-CHAN, SI, TO-71	80009	151-1036-00
Q550	151-0427-00			TRANSISTOR: NPN, SI, TO-92	07263	S39287
Q562	151-0325-00	B010100	B079999	TRANSISTOR: PNP, SI, TO-92, SEL	80009	151-0325-00
Q562	151-0221-00	B080000		TRANSISTOR: PNP, SI, TO-92	80009	151-0221-00
Q564	151-0325-00	B010100	B079999	TRANSISTOR: PNP, SI, TO-92, SEL	80009	151-0325-00
Q564	151-0221-00	B080000		TRANSISTOR: PNP, SI, TO-92	80009	151-0221-00
Q568	151-0367-00			TRANSISTOR: NPN, SI, X-55	04713	SPS 8811
Q572	151-0223-00			TRANSISTOR: NPN, SI, TO-92	04713	SPS8026
Q574	151-0367-00			TRANSISTOR: NPN, SI, X-55	04713	SPS 8811
Q582	151-0424-00			TRANSISTOR: NPN, SI, TO-92	04713	SPS8246
Q584	151-0192-00			TRANSISTOR: SELECTED	04713	SPS8801
Q602	151-0424-00			TRANSISTOR: NPN, SI, TO-92	04713	SPS8246
Q606	151-0325-00	B010100	B079999	TRANSISTOR: PNP, SI, TO-92, SEL	80009	151-0325-00
Q606	151-0221-00	B080000		TRANSISTOR: PNP, SI, TO-92	80009	151-0221-00
Q798	151-0302-00			TRANSISTOR: NPN, SI, TO-18	04713	ST899
Q802	151-0325-00			TRANSISTOR: PNP, SI, TO-92, SEL	80009	151-0325-00
Q804	151-0325-00	B010100	B079999	TRANSISTOR: PNP, SI, TO-92, SEL	80009	151-0325-00
Q804	151-0221-00	B080000		TRANSISTOR: PNP, SI, TO-92	80009	151-0221-00
Q806	151-0424-00			TRANSISTOR: NPN, SI, TO-92	04713	SPS8246
Q810	151-0220-00			TRANSISTOR: PNP, SI, TO-92	80009	151-0220-00
Q812	151-0424-00			TRANSISTOR: NPN, SI, TO-92	04713	SPS8246
Q816	151-0424-00			TRANSISTOR: NPN, SI, TO-92	04713	SPS8246
Q818	151-0424-00			TRANSISTOR: NPN, SI, TO-92	04713	SPS8246
Q844	151-0301-00			TRANSISTOR: PNP, SI, TO-18	04713	ST898
Q852	151-0424-00			TRANSISTOR: NPN, SI, TO-92	04713	SPS8246
Q854	151-0424-00			TRANSISTOR: NPN, SI, TO-92	04713	SPS8246
Q864	151-0302-00			TRANSISTOR: NPN, SI, TO-18	04713	ST899
Q874	151-0424-00			TRANSISTOR: NPN, SI, TO-92	04713	SPS8246
Q876	151-0424-00			TRANSISTOR: NPN, SI, TO-92	04713	SPS8246
Q882	151-0367-00	B010100	B059999	TRANSISTOR: NPN, SI, X-55	04713	SPS 8811
Q882	151-0223-00	B060000		TRANSISTOR: NPN, SI, TO-92	04713	SPS8026

Replaceable Electrical Parts - 7B92A

Component No.	Tektronix Part No.	Serial/Assembly No. Effective	Dscont	Name & Description	Mfr. Code	Mfr. Part No.
Q884	151-0367-00	B010100	B059999	TRANSISTOR:NPN,SI,X-55	04713	SPS 8811
Q884	151-0223-00	B060000		TRANSISTOR:NPN,SI,TO-92	04713	SPS8026
Q890	151-0424-00			TRANSISTOR:NPN,SI,TO-92	04713	SPS8246
Q892	151-0192-00			TRANSISTOR:SELECTED	04713	SPS8801
Q894	151-0192-00			TRANSISTOR:SELECTED	04713	SPS8801
Q900	151-0325-00	B010100	B079999	TRANSISTOR:PNP,SI,TO-92,SEL	80009	151-0325-00
Q900	151-0221-00	B080000		TRANSISTOR:PNP,SI,TO-92	80009	151-0221-00
Q902	151-0367-00			TRANSISTOR:NPN,SI,X-55	04713	SPS 8811
Q904	151-0223-00			TRANSISTOR:NPN,SI,TO-92	04713	SPS8026
Q910	151-0325-00	B010100	B079999	TRANSISTOR:PNP,SI,TO-92,SEL	80009	151-0325-00
Q910	151-0221-00	B080000		TRANSISTOR:PNP,SI,TO-92	80009	151-0221-00
Q912	151-0367-00			TRANSISTOR:NPN,SI,X-55	04713	SPS 8811
Q914	151-0223-00			TRANSISTOR:NPN,SI,TO-92	04713	SPS8026
Q922	151-0220-00			TRANSISTOR:PNP,SI,TO-92	80009	151-0220-00
Q926	151-0220-00			TRANSISTOR:PNP,SI,TO-92	80009	151-0220-00
Q928	151-0220-00			TRANSISTOR:PNP,SI,TO-92	80009	151-0220-00
Q932	151-0424-00			TRANSISTOR:NPN,SI,TO-92	04713	SPS8246
Q934	151-0221-00			TRANSISTOR:PNP,SI,TO-92	80009	151-0221-00
Q938	151-0410-00			TRANSISTOR:PNP,SI,TO-92	04713	SPS6765
Q940	151-0325-00	B010100	B079999	TRANSISTOR:PNP,SI,TO-92,SEL	80009	151-0325-00
Q940	151-0221-00	B080000		TRANSISTOR:PNP,SI,TO-92	80009	151-0221-00
Q942	151-0437-00			TRANSISTOR:SELECTED	80009	151-0437-00
Q952	151-0437-00			TRANSISTOR:SELECTED	80009	151-0437-00
Q960	151-0302-00			TRANSISTOR:NPN,SI,TO-18	04713	ST899
Q978	151-0301-00			TRANSISTOR:PNP,SI,TO-18	04713	ST898
R2	317-0680-00			RES,FXD,CMPSN:68 OHM,5%,0.125W	01121	BB6805
R3	303-0680-00			RES,FXD,CMPSN:68 OHM,5%,1W	01121	GB6805
R4	315-0181-00			RES,FXD,FILM:180 OHM,5%,0.25W	57668	NTR25J-E180E
R7	315-0131-00			RES,FXD,FILM:130 OHM,5%,0.25W	19701	5043CX130R0J
R8	315-0105-00			RES,FXD,FILM:1M OHM,5%,0.25W	19701	5043CX1M000J
R9	317-0510-00			RES,FXD,CMPSN:51 OHM,5%,0.125W	01121	BB5105
R10	315-0915-00			RES,FXD,FILM:9.1M OHM,5%,0.25W	01121	CB9155
R11	317-0471-00			RES,FXD,CMPSN:470 OHM,5%,0.125W	01121	BB4715
R12	315-0824-00			RES,FXD,FILM:820K OHM,5%,0.25W	19701	5043CX820K0J
R13	315-0274-00			RES,FXD,FILM:270K OHM,5%,0.25W	57668	NTR25J-E270K
R14	315-0512-00			RES,FXD,FILM:5.1K OHM,5%,0.25W	57668	NTR25J-E05K1
R15	315-0204-00			RES,FXD,FILM:200K OHM,5%,0.25W	19701	5043CX200K0J
R17	315-0101-00			RES,FXD,FILM:100 OHM,5%,0.25W	57668	NTR25J-E 100E
R18	315-0122-00			RES,FXD,FILM:1.2K OHM,5%,0.25W	57668	NTR25J-E01K2
R20	315-0102-00			RES,FXD,FILM:1K OHM,5%,0.25W	57668	NTR25JE01K0
R21	315-0393-00	B010100	B069999	RES,FXD,FILM:39K OHM,5%,0.25W	57668	NTR25J-E39K0
R22	315-0750-00			RES,FXD,FILM:75 OHM,5%,0.25W	57668	NTR25J-E75E0
R24	315-0152-00			RES,FXD,FILM:1.5K OHM,5%,0.25W	57668	NTR25J-E01K5
R25	311-1268-00	B010100	B069999	RES,VAR,NONNW:TRMR,10K OHM,0.5W	32997	3329P-L58-103
R28	315-0101-00			RES,FXD,FILM:100 OHM,5%,0.25W	57668	NTR25J-E 100E
R29	315-0301-00			RES,FXD,FILM:300 OHM,5%,0.25W	57668	NTR25J-E300E
R34	315-0102-00			RES,FXD,FILM:1K OHM,5%,0.25W	57668	NTR25JE01K0
R36	315-0151-00			RES,FXD,FILM:150 OHM,5%,0.25W	57668	NTR25J-E150E
R37	315-0102-00			RES,FXD,FILM:1K OHM,5%,0.25W	57668	NTR25JE01K0
R38	315-0123-00			RES,FXD,FILM:12K OHM,5%,0.25W	57668	NTR25J-E12K0
R41	315-0472-00			RES,FXD,FILM:4.7K OHM,5%,0.25W	57668	NTR25J-E04K7
R42	315-0202-00			RES,FXD,FILM:2K OHM,5%,0.25W	57668	NTR25J-E 2K
R43	315-0203-00			RES,FXD,FILM:20K OHM,5%,0.25W	57668	NTR25J-E 20K
R44	315-0203-00			RES,FXD,FILM:20K OHM,5%,0.25W	57668	NTR25J-E 20K
R46	315-0560-00			RES,FXD,FILM:56 OHM,5%,0.25W	57668	NTR25J-E56E0
R48	315-0471-00	B010100	B069999	RES,FXD,FILM:470 OHM,5%,0.25W	57668	NTR25J-E470E
R50	311-1192-00	B010100	B098500	RES,VAR,NONNW:PNL,10K OHM,1W,W/SW	12697	381-CM39695

Component No.	Tektronix Part No.	Serial/Assembly No.		Name & Description	Mfr. Code	Mfr. Part No.
		Effective	Discont			
R50	311-2303-00	B098501		RES,VAR, NONWV:PNL,10K OHM,10%,LINEAR,0.25W	12697	CM45205
R51	315-0363-00	B010100	B069999	RES,FXD,FILM:36K OHM,5%,0.25W	57668	NTR25J-E36K0
R52	315-0153-00	B010100	B069999	RES,FXD,FILM:15K OHM,5%,0.25W	19701	5043CX15K00J
R53	315-0392-00	B010100	B069999	RES,FXD,FILM:3.9K OHM,5%,0.25W	57668	NTR25J-E03K9
R54	315-0563-00			RES,FXD,FILM:56K OHM,5%,0.25W	19701	5043CX56K00J
R55	315-0621-00	B010100	B069999	RES,FXD,FILM:620 OHM,5%,0.25W	57668	NTR25J-E620E
R56	315-0153-00	B010100	B069999	RES,FXD,FILM:15K OHM,5%,0.25W	19701	5043CX15K00J
R57	315-0203-00	B010100	B069999	RES,FXD,FILM:20K OHM,5%,0.25W	57668	NTR25J-E 20K
R58	315-0513-00	B010100	B069999	RES,FXD,FILM:51K OHM,5%,0.25W	57668	NTR25J-E51K0
R59	311-1559-00	B010100	B069999	RES,VAR, NONWV:TRMR,10K OHM,0.5W	32997	3352T-1-103
R61	315-0471-00	B010100	B069999	RES,FXD,FILM:470 OHM,5%,0.25W	57668	NTR25J-E470E
R63	315-0102-00	B010100	B069999	RES,FXD,FILM:1K OHM,5%,0.25W	57668	NTR25JE01K0
R64	315-0822-00			RES,FXD,FILM:8.2K OHM,5%,0.25W	19701	5043CX8K200J
R65	315-0272-00	B010100	B069999	RES,FXD,FILM:2.7K OHM,5%,0.25W	57668	NTR25J-E02K7
R66	315-0152-00	B010100	B069999	RES,FXD,FILM:1.5K OHM,5%,0.25W	57668	NTR25J-E01K5
R66	315-0102-00	B070000		RES,FXD,FILM:1K OHM,5%,0.25W	57668	NTR25JE01K0
R67	315-0152-00	B010100	B069999	RES,FXD,FILM:1.5K OHM,5%,0.25W	57668	NTR25J-E01K5
R67	315-0471-00	B070000		RES,FXD,FILM:470 OHM,5%,0.25W	57668	NTR25J-E470E
R68	315-0682-00	B010100	B069999	RES,FXD,FILM:6.8K OHM,5%,0.25W	57668	NTR25J-E06K8
R68	315-0103-00	B070000		RES,FXD,FILM:10K OHM,5%,0.25W	19701	5043CX10K00J
R69	315-0272-00	B070000		RES,FXD,FILM:2.7K OHM,5%,0.25W	57668	NTR25J-E02K7
R70	315-0391-00	B070000		RES,FXD,FILM:390 OHM,5%,0.25W	57668	NTR25J-E390E
R71	315-0152-00	B010100	B069999	RES,FXD,FILM:1.5K OHM,5%,0.25W	57668	NTR25J-E01K5
R71	315-0620-00	B070000		RES,FXD,FILM:62 OHM,5%,0.25W	19701	5043CX63R00J
R72	315-0511-00	B010100	B069999	RES,FXD,FILM:510 OHM,5%,0.25W	19701	5043CX510R0J
R72	315-0203-00	B070000		RES,FXD,FILM:20K OHM,5%,0.25W	57668	NTR25J-E 20K
R73	317-0101-00	B010100	B069999	RES,FXD,CMPSN:100 OHM,5%,0.125W	01121	BB1015
R73	315-0512-00	B070000		RES,FXD,FILM:5.1K OHM,5%,0.25W	57668	NTR25J-E05K1
R74	315-0511-00	B010100	B069999	RES,FXD,FILM:510 OHM,5%,0.25W	19701	5043CX510R0J
R74	315-0102-00	B070000		RES,FXD,FILM:1K OHM,5%,0.25W	57668	NTR25JE01K0
R75	317-0101-00	B010100	B069999	RES,FXD,CMPSN:100 OHM,5%,0.125W	01121	BB1015
R75	311-1268-00	B070000		RES,VAR, NONWV:TRMR,10K OHM,0.5W	32997	3329P-L58-103
R76	315-0160-00	B010100	B069999	RES,FXD,FILM:16 OHM,5%,0.25W	19701	5043CX16R00J
R76	315-0391-00	B070000		RES,FXD,FILM:390 OHM,5%,0.25W	57668	NTR25J-E390E
R77	317-0121-00	B010100	B069999	RES,FXD,CMPSN:120 OHM,5%,0.125W	01121	BB1215
R77	315-0361-00	B070000		RES,FXD,FILM:360 OHM,5%,0.25W	19701	5043CX360R0J
R78	317-0121-00	B010100	B069999	RES,FXD,CMPSN:120 OHM,5%,0.125W	01121	BB1215
R78	315-0391-00	B070000		RES,FXD,FILM:390 OHM,5%,0.25W	57668	NTR25J-E390E
R79	315-0272-00	B010100	B069999	RES,FXD,FILM:2.7K OHM,5%,0.25W	57668	NTR25J-E02K7
R79	315-0361-00	B070000		RES,FXD,FILM:360 OHM,5%,0.25W	19701	5043CX360R0J
R80	315-0162-00	B010100	B069999	RES,FXD,FILM:1.6K OHM,5%,0.25W	19701	5043CX1K600J
R81	315-0622-00	B010100	B069999	RES,FXD,FILM:6.2K OHM,5%,0.25W	19701	5043CX6K200J
R82	315-0681-00	B010100	B069999	RES,FXD,FILM:680 OHM,5%,0.25W	57668	NTR25J-E680E
R82	301-0511-00	B070000		RES,FXD,FILM:510 OHM,5%,0.5W	19701	5053CX510R0J
R83	315-0103-00	B010100	B069999	RES,FXD,FILM:10K OHM,5%,0.25W	19701	5043CX10K00J
R83	315-0620-00	B070000		RES,FXD,FILM:62 OHM,5%,0.25W	19701	5043CX63R00J
R84	315-0103-00	B010100	B069999	RES,FXD,FILM:10K OHM,5%,0.25W	19701	5043CX10K00J
R85	315-0160-00	B070000	B094999	RES,FXD,FILM:16 OHM,5%,0.25W	19701	5043CX16R00J
R85	315-0180-00	B095000		RES,FXD,FILM:18 OHM,5%,0.25W	19701	5043CX18R00J
R86	315-0112-00	B010100	B069999	RES,FXD,FILM:1.1K OHM,5%,0.25W	19701	5043CX1K100J
R86	301-0511-00	B070000		RES,FXD,FILM:510 OHM,5%,0.5W	19701	5053CX510R0J
R87	315-0361-00	B010100	B069999	RES,FXD,FILM:360 OHM,5%,0.25W	19701	5043CX360R0J
R87	315-0620-00	B070000		RES,FXD,FILM:62 OHM,5%,0.25W	19701	5043CX63R00J
R88	315-0361-00	B010100	B069999	RES,FXD,FILM:360 OHM,5%,0.25W	19701	5043CX360R0J
R88	315-0391-00	B070000	B094999	RES,FXD,FILM:390 OHM,5%,0.25W	57668	NTR25J-E390E
R88	315-0361-00	B095000		RES,FXD,FILM:360 OHM,5%,0.25W	19701	5043CX360R0J
R89	315-0361-00	B070000		RES,FXD,FILM:360 OHM,5%,0.25W	19701	5043CX360R0J
R90	311-1259-00	B095000		RES,VAR, NONWV:TRMR,100 OHM,0.5W	32997	3329P-L58-101

Replaceable Electrical Parts - 7B92A

Component No.	Tektronix Part No.	Serial/Assembly No. Effective	Discont	Name & Description	Mfr. Code	Mfr. Part No.
R91	315-0471-00	B010100	B069999	RES, FXD, FILM: 470 OHM, 5%, 0.25W	57668	NTR25J-E470E
R91	315-0153-00	B070000		RES, FXD, FILM: 15K OHM, 5%, 0.25W	19701	5043CX15K00J
R92	315-0621-00	B010100	B069999	RES, FXD, FILM: 620 OHM, 5%, 0.25W	57668	NTR25J-E620E
R92	315-0363-00	B070000		RES, FXD, FILM: 36K OHM, 5%, 0.25W	57668	NTR25J-E36K0
R93	315-0392-00	B070000		RES, FXD, FILM: 3.9K OHM, 5%, 0.25W	57668	NTR25J-E03K9
R94	317-0510-00	B010100	B069999	RES, FXD, CMPSN: 51 OHM, 5%, 0.125W	01121	BB5105
R94	315-0513-00	B070000		RES, FXD, FILM: 51K OHM, 5%, 0.25W	57668	NTR25J-E51K0
R95	317-0510-00	B010100	B069999	RES, FXD, CMPSN: 51 OHM, 5%, 0.125W	01121	BB5105
R96	315-0181-00	B010100	B069999	RES, FXD, FILM: 180 OHM, 5%, 0.25W	57668	NTR25J-E180E
R96	315-0153-00	B070000		RES, FXD, FILM: 15K OHM, 5%, 0.25W	19701	5043CX15K00J
R97	315-0132-00	B010100	B069999	RES, FXD, FILM: 1.3K OHM, 5%, 0.25W	57668	NTR25J-E01K3
R97	315-0621-00	B070000		RES, FXD, FILM: 620 OHM, 5%, 0.25W	57668	NTR25J-E620E
R98	315-0203-00	B070000		RES, FXD, FILM: 20K OHM, 5%, 0.25W	57668	NTR25J-E 20K
R99	311-1559-00	B070000		RES, VAR, NONW: TRMR, 10K OHM, 0.5W	32997	3352T-1-103
R100	315-0162-00	B070000		RES, FXD, FILM: 1.6K OHM, 5%, 0.25W	19701	5043CX1K600J
R101	315-0622-00	B070000		RES, FXD, FILM: 6.2K OHM, 5%, 0.25W	19701	5043CX6K200J
R102	315-0750-00	B010100	B069999	RES, FXD, FILM: 75 OHM, 5%, 0.25W	57668	NTR25J-E75E0
R102	315-0112-00	B070000		RES, FXD, FILM: 1.1K OHM, 5%, 0.25W	19701	5043CX1K100J
R103	315-0121-00	B010100	B069999	RES, FXD, FILM: 120 OHM, 5%, 0.25W	19701	5043CX120R0J
R104	315-0201-00	B010100	B069999	RES, FXD, FILM: 200 OHM, 5%, 0.25W	57668	NTR25J-E200E
R105	315-0103-00	B010100	B069999	RES, FXD, FILM: 10K OHM, 5%, 0.25W	19701	5043CX10K00J
R106	315-0512-00	B010100	B069999	RES, FXD, FILM: 5.1K OHM, 5%, 0.25W	57668	NTR25J-E05K1
R106	315-0681-00	B070000		RES, FXD, FILM: 680 OHM, 5%, 0.25W	57668	NTR25J-E680E
R107	317-0511-00	B010100	B069999	RES, FXD, CMPSN: 510 OHM, 5%, 0.125W	01121	BB5115
R107	315-0103-00	B070000		RES, FXD, FILM: 10K OHM, 5%, 0.25W	19701	5043CX10K00J
R108	317-0512-00	B010100	B069999	RES, FXD, CMPSN: 5.1K OHM, 5%, 0.125	01121	BB5125
R108	315-0203-00	B070000		RES, FXD, FILM: 20K OHM, 5%, 0.25W	57668	NTR25J-E 20K
R109	315-0513-00	B070000		RES, FXD, FILM: 51K OHM, 5%, 0.25W	57668	NTR25J-E51K0
R110	315-0104-00	B09500		RES, FXD, FILM: 100K OHM, 5%, 0.25W	57668	NTR25J-E100K
R111	317-0270-00	B010100	B069999	RES, FXD, CMPSN: 27 OHM, 5%, 0.125W	01121	BB2705
R112	315-0510-00	B010100	B069999	RES, FXD, FILM: 51 OHM, 5%, 0.25W	19701	5043CX51R00J
R112	315-0102-00	B070000		RES, FXD, FILM: 1K OHM, 5%, 0.25W	57668	NTR25JE01K0
R113	315-0510-00	B010100	B069999	RES, FXD, FILM: 51 OHM, 5%, 0.25W	19701	5043CX51R00J
R113	315-0123-00	B070000		RES, FXD, FILM: 12K OHM, 5%, 0.25W	57668	NTR25J-E12K0
R114	315-0100-00	B010100	B069999	RES, FXD, FILM: 10 OHM, 5%, 0.25W	19701	5043CX10R00J
R114	315-0682-00	B070000		RES, FXD, FILM: 6.8K OHM, 5%, 0.25W	57668	NTR25J-E06K8
R115	315-0102-00	B010100	B069999	RES, FXD, FILM: 1K OHM, 5%, 0.25W	57668	NTR25JE01K0
R116	315-0112-00	B010100	B069999	RES, FXD, FILM: 1.1K OHM, 5%, 0.25W	19701	5043CX1K100J
R117	315-0112-00	B010100	B069999	RES, FXD, FILM: 1.1K OHM, 5%, 0.25W	19701	5043CX1K100J
R118	315-0122-00	B010100	B069999	RES, FXD, FILM: 1.2K OHM, 5%, 0.25W	57668	NTR25J-E01K2
R121	321-0222-00	B010100	B069999	RES, FXD, FILM: 2.00K OHM, 1%, 0.125W, TC=TO	19701	5033ED2K00F
R122	321-0260-00	B010100	B069999	RES, FXD, FILM: 4.99K OHM, 1%, 0.125W, TC=TO	19701	5033ED4K990F
R123	315-0201-00	B010100	B069999	RES, FXD, FILM: 200 OHM, 5%, 0.25W	57668	NTR25J-E200E
R124	317-0240-00	B010100	B069999	RES, FXD, CMPSN: 24 OHM, 5%, 0.125W	01121	BB2405
R124	315-0472-00	B070000		RES, FXD, FILM: 4.7K OHM, 5%, 0.25W	57668	NTR25J-E04K7
R125	311-1258-00	B010100	B069999	RES, VAR, NONW: TRMR, 50 OHM, 0.5W	32997	3329P-L58-500
R127	315-0512-00	B010100	B069999	RES, FXD, FILM: 5.1K OHM, 5%, 0.25W	57668	NTR25J-E05K1
R128	315-0244-00	B010100	B069999	RES, FXD, FILM: 240K OHM, 5%, 0.25W	19701	5043CX240K0J
R129	315-0823-00	B010100	B069999	RES, FXD, FILM: 82K OHM, 5%, 0.25W	57668	NTR25J-E82K
R131	315-0103-00	B070000		RES, FXD, FILM: 10K OHM, 5%, 0.25W	19701	5043CX10K00J
R132	315-0272-00	B010100	B069999	RES, FXD, FILM: 2.7K OHM, 5%, 0.25W	57668	NTR25J-E02K7
R132	315-0103-00	B070000		RES, FXD, FILM: 10K OHM, 5%, 0.25W	19701	5043CX10K00J
R133	315-0202-00	B010100	B069999	RES, FXD, FILM: 2K OHM, 5%, 0.25W	57668	NTR25J-E 2K
R133	315-0473-00	B070000		RES, FXD, FILM: 47K OHM, 5%, 0.25W	57668	NTR25J-E47K0
R134	315-0473-00	B070000		RES, FXD, FILM: 47K OHM, 5%, 0.25W	57668	NTR25J-E47K0
R135	315-0103-00	B010100	B069999	RES, FXD, FILM: 10K OHM, 5%, 0.25W	19701	5043CX10K00J
R135	315-0163-00	B070000		RES, FXD, FILM: 16K OHM, 5%, 0.25W	57668	NTR25J-E 16K
R137	315-0474-00	B070000		RES, FXD, FILM: 470K OHM, 5%, 0.25W	19701	5043CX470K0J92U

Component No.	Tektronix Part No.	Serial/Assembly No. Effective	Discont	Name & Description	Mfr. Code	Mfr. Part No.
R138	315-0473-00	B070000		RES,FXD,FILM:47K OHM,5%,0.25W	57668	NTR25J-E47K0
R139	315-0122-00	B070000		RES,FXD,FILM:1.2K OHM,5%,0.25W	57668	NTR25J-E01K2
R140	315-0472-00	B070000		RES,FXD,FILM:4.7K OHM,5%,0.25W	57668	NTR25J-E04K7
R141	315-0101-00	B070000		RES,FXD,FILM:100 OHM,5%,0.25W	57668	NTR25J-E 100E
R142	315-0220-00	B010100	B069999	RES,FXD,FILM:22 OHM,5%,0.25W	19701	5043CX22R00J
R142	315-0391-00	B070000		RES,FXD,FILM:390 OHM,5%,0.25W	57668	NTR25J-E390E
R143	315-0122-00	B010100	B069999	RES,FXD,FILM:1.2K OHM,5%,0.25W	57668	NTR25J-E01K2
R144	315-0471-00	B070000		RES,FXD,FILM:470 OHM,5%,0.25W	57668	NTR25J-E470E
R145	311-1267-00	B010100	B069999	RES,VAR,NONWV:TRMR,5K OHM,0.5W	32997	3329P-L58-502
R145	315-0101-00	B070000		RES,FXD,FILM:100 OHM,5%,0.25W	57668	NTR25J-E 100E
R146	315-0202-00	B010100	B069999	RES,FXD,FILM:2K OHM,5%,0.25W	57668	NTR25J-E 2K
R148	315-0391-00	B010100	B069999	RES,FXD,FILM:390 OHM,5%,0.25W	57668	NTR25J-E390E
R149	315-0471-00	B010100	B069999	RES,FXD,FILM:470 OHM,5%,0.25W	57668	NTR25J-E470E
R151	315-0102-00	B010100	B069999	RES,FXD,FILM:1K OHM,5%,0.25W	57668	NTR25JE01K0
R151	315-0472-00	B070000		RES,FXD,FILM:4.7K OHM,5%,0.25W	57668	NTR25J-E04K7
R152	315-0220-00	B010100	B069999	RES,FXD,FILM:22 OHM,5%,0.25W	19701	5043CX22R00J
R152	315-0181-00	B070000		RES,FXD,FILM:180 OHM,5%,0.25W	57668	NTR25J-E180E
R153	315-0113-00	B010100	B069999	RES,FXD,FILM:11K OHM,5%,0.25W	19701	5043CX11K00J
R153	315-0220-00	B070000		RES,FXD,FILM:22 OHM,5%,0.25W	19701	5043CX22R00J
R154	315-0201-00	B070000		RES,FXD,FILM:200 OHM,5%,0.25W	57668	NTR25J-E200E
R155	311-1267-00	B010100	B069999	RES,VAR,NONWV:TRMR,5K OHM,0.5W	32997	3329P-L58-502
R156	315-0202-00	B010100	B069999	RES,FXD,FILM:2K OHM,5%,0.25W	57668	NTR25J-E 2K
R158	315-0201-00	B010100	B069999	RES,FXD,FILM:200 OHM,5%,0.25W	57668	NTR25J-E200E
R159	315-0471-00	B010100	B069999	RES,FXD,FILM:470 OHM,5%,0.25W	57668	NTR25J-E470E
R161	315-0202-00	B010100	B069999	RES,FXD,FILM:2K OHM,5%,0.25W	57668	NTR25J-E 2K
R161	315-0470-00	B070000		RES,FXD,FILM:47 OHM,5%,0.25W	57668	NTR25J-E47E0
R162	315-0103-00	B070000		RES,FXD,FILM:10K OHM,5%,0.25W	19701	5043CX10K00J
R162	315-0622-00	B010100	B069999	RES,FXD,FILM:6.2K OHM,5%,0.25W	19701	5043CX6K200J
R162	315-0103-00	B070000		RES,FXD,FILM:10K OHM,5%,0.25W	19701	5043CX10K00J
R164	315-0102-00	B010100	B069999	RES,FXD,FILM:1K OHM,5%,0.25W	57668	NTR25JE01K0
R165	315-0122-00	B010100	B069999	RES,FXD,FILM:1.2K OHM,5%,0.25W	57668	NTR25J-E01K2
R165	321-0260-00	B070000		RES,FXD,FILM:4.99K OHM,1%,0.125W,TC=TO	19701	5033ED4K990F
R166	321-0260-00	B070000		RES,FXD,FILM:4.99K OHM,1%,0.125W,TC=TO	19701	5033ED4K990F
R167	315-0102-00	B070000		RES,FXD,FILM:1K OHM,5%,0.25W	57668	NTR25JE01K0
R170	315-0223-00	B070000		RES,FXD,FILM:22K OHM,5%,0.25W	19701	5043CX22K00J92U
R171	317-0470-00	B010100	B069999	RES,FXD,CMPSN:47 OHM,5%,0.125W	01121	BB4705
R172	315-0473-00	B070000		RES,FXD,FILM:47K OHM,5%,0.25W	57668	NTR25J-E47K0
R173	317-0101-00	B010100	B069999	RES,FXD,CMPSN:100 OHM,5%,0.125W	01121	BB1015
R173	315-0473-00	B070000		RES,FXD,FILM:47K OHM,5%,0.25W	57668	NTR25J-E47K0
R174	315-0223-00	B070000		RES,FXD,FILM:22K OHM,5%,0.25W	19701	5043CX22K00J92U
R175	317-0470-00	B010100	B069999	RES,FXD,CMPSN:47 OHM,5%,0.125W	01121	BB4705
R175	311-1224-00	B070000		RES,VAR,NONWV:TRMR,500 OHM,0.5W	32997	3386F-T04-501
R176	317-0201-00	B010100	B069999	RES,FXD,CMPSN:200 OHM,5%,0.125W	01121	BB2015
R176	315-0391-00	B070000		RES,FXD,FILM:390 OHM,5%,0.25W	57668	NTR25J-E390E
R177	317-0510-00	B010100	B069999	RES,FXD,CMPSN:51 OHM,5%,0.125W	01121	BB5105
R177	315-0151-00	B070000		RES,FXD,FILM:150 OHM,5%,0.25W	57668	NTR25J-E150E
R202	317-0680-00			RES,FXD,CMPSN:68 OHM,5%,0.125W	01121	BB6805
R203	303-0680-00			RES,FXD,CMPSN:68 OHM,5%,1W	01121	GB6805
R204	315-0181-00			RES,FXD,FILM:180 OHM,5%,0.25W	57668	NTR25J-E180E
R207	315-0131-00			RES,FXD,FILM:130 OHM,5%,0.25W	19701	5043CX130R0J
R212	317-0824-00			RES,FXD,CMPSN:820K OHM,5%,0.125W	01121	BB8245
R213	317-0512-00			RES,FXD,CMPSN:5.1K OHM,5%,0.125	01121	BB5125
R214	315-0510-00			RES,FXD,FILM:51 OHM,5%,0.25W	19701	5043CX51R00J
R215	315-0244-00			RES,FXD,FILM:240K OHM,5%,0.25W	19701	5043CX240K0J
R217	315-0101-00			RES,FXD,FILM:100 OHM,5%,0.25W	57668	NTR25J-E 100E
R222	315-0750-00	B070000		RES,FXD,FILM:75 OHM,5%,0.25W	57668	NTR25J-E75E0
R224	315-0152-00	B070000		RES,FXD,FILM:1.5K OHM,5%,0.25W	57668	NTR25J-E01K5
R225	311-1268-00	B010100	B069999	RES,VAR,NONWV:TRMR,10K OHM,0.5W	32997	3329P-L58-103

Replaceable Electrical Parts - 7B92A

Component No.	Tektronix Part No.	Serial/Assembly No. Effective	Discont	Name & Description	Mfr. Code	Mfr. Part No.
R226	315-0512-00	B010100	B069999	RES, FXD, FILM: 5.1K OHM, 5%, 0.25W	57668	NTR25J-E05K1
R228	315-0101-00			RES, FXD, FILM: 100 OHM, 5%, 0.25W	57668	NTR25J-E 100E
R229	315-0301-00			RES, FXD, FILM: 300 OHM, 5%, 0.25W	57668	NTR25J-E300E
R230	311-1268-00	B070000		RES, VAR, NONNW: TRMR, 10K OHM, 0.5W	32997	3329P-L58-103
R231	315-0152-00	B010100	B069999	RES, FXD, FILM: 1.5K OHM, 5%, 0.25W	57668	NTR25J-E01K5
R231	315-0512-00	B070000		RES, FXD, FILM: 5.1K OHM, 5%, 0.25W	57668	NTR25J-E05K1
R233	315-0750-00	B010100	B069999	RES, FXD, FILM: 75 OHM, 5%, 0.25W	57668	NTR25J-E75E0
R238	315-0471-00	B010100	B069999	RES, FXD, FILM: 470 OHM, 5%, 0.25W	57668	NTR25J-E470E
R241	315-0432-00			RES, FXD, FILM: 4.3K OHM, 5%, 0.25W	57668	NTR25J-E04K3
R243	315-0512-00	B010100	B069999	RES, FXD, FILM: 5.1K OHM, 5%, 0.25W	57668	NTR25J-E05K1
R243	315-0471-00	B070000		RES, FXD, FILM: 470 OHM, 5%, 0.25W	57668	NTR25J-E470E
R244	315-0512-00	B070000		RES, FXD, FILM: 5.1K OHM, 5%, 0.25W	57668	NTR25J-E05K1
R245	311-1559-00	B010100	B069999	RES, VAR, NONNW: TRMR, 10K OHM, 0.5W	32997	3352T-1-103
R245	315-0912-00	B070000		RES, FXD, FILM: 9.1K OHM, 5%, 0.25W	57668	NTR25J-E09K1
R246	315-0560-00			RES, FXD, FILM: 56 OHM, 5%, 0.25W	57668	NTR25J-E56E0
R247	315-0202-00			RES, FXD, FILM: 2K OHM, 5%, 0.25W	57668	NTR25J-E 2K
R248	315-0103-00	B010100	B069999	RES, FXD, FILM: 10K OHM, 5%, 0.25W	19701	5043CX10K00J
R250	311-1322-00			RES, VAR, NONNW: PNL, 5K OHM, 1W, W/SW	12697	381-CM39701
R251	315-0203-00	B010100	B069999	RES, FXD, FILM: 20K OHM, 5%, 0.25W	57668	NTR25J-E 20K
R251	315-0513-00	B070000		RES, FXD, FILM: 51K OHM, 5%, 0.25W	57668	NTR25J-E51K0
R252	315-0513-00	B010100	B069999	RES, FXD, FILM: 51K OHM, 5%, 0.25W	57668	NTR25J-E51K0
R252	315-0203-00	B070000		RES, FXD, FILM: 20K OHM, 5%, 0.25W	57668	NTR25J-E 20K
R253	315-0103-00	B010100	B069999	RES, FXD, FILM: 10K OHM, 5%, 0.25W	19701	5043CX10K00J
R253	301-0472-00	B070000		RES, FXD, FILM: 4.7K OHM, 5%, 0.5W	19701	5053CX4K700J
R254	315-0473-00	B010100	B069999	RES, FXD, FILM: 47K OHM, 5%, 0.25W	57668	NTR25J-E47K0
R254	311-1559-00	B070000	B096950	RES, VAR, NONNW: TRMR, 10K OHM, 0.5W	32997	3352T-1-103
R254	311-1228-00	B096951		RES, VAR, NONNW: TRMR, 10K OHM, 0.5W	32997	3386F-T04-103
R255	315-0113-00	B010100	B069999	RES, FXD, FILM: 11K OHM, 5%, 0.25W (NOMINAL VALUE, SELECTED)	19701	5043CX11K00J
R255	311-1559-00	B070000	B096950	RES, VAR, NONNW: TRMR, 10K OHM, 0.5W	32997	3352T-1-103
R255	311-1228-00	B096951		RES, VAR, NONNW: TRMR, 10K OHM, 0.5W	32997	3386F-T04-103
R256	315-0132-00	B010100	B069999	RES, FXD, FILM: 1.3K OHM, 5%, 0.25W	57668	NTR25J-E01K3
R256	315-0243-00	B070000		RES, FXD, FILM: 24K OHM, 5%, 0.25W	57668	NTR25J-E24K0
R257	315-0133-00	B010100	B069999	RES, FXD, FILM: 13K OHM, 5%, 0.25W	19701	5043CX13K00J
R257	315-0103-00	B070000		RES, FXD, FILM: 10K OHM, 5%, 0.25W	19701	5043CX10K00J
R258	315-0622-00	B010100	B069999	RES, FXD, FILM: 6.2K OHM, 5%, 0.25W	19701	5043CX6K200J
R259	315-0912-00	B010100	B069999	RES, FXD, FILM: 9.1K OHM, 5%, 0.25W	57668	NTR25J-E09K1
R261	315-0471-00	B010100	B069999	RES, FXD, FILM: 470 OHM, 5%, 0.25W	57668	NTR25J-E470E
R261	315-0132-00	B070000		RES, FXD, FILM: 1.3K OHM, 5%, 0.25W	57668	NTR25J-E01K3
R262	315-0102-00	B010100	B069999	RES, FXD, FILM: 1K OHM, 5%, 0.25W	57668	NTR25JE01K0
R262	315-0133-00	B070000		RES, FXD, FILM: 13K OHM, 5%, 0.25W	19701	5043CX13K00J
R263	315-0102-00	B010100	B069999	RES, FXD, FILM: 1K OHM, 5%, 0.25W	57668	NTR25JE01K0
R263	315-0622-00	B070000		RES, FXD, FILM: 6.2K OHM, 5%, 0.25W	19701	5043CX6K200J
R264	315-0103-00	B070000		RES, FXD, FILM: 10K OHM, 5%, 0.25W	19701	5043CX10K00J
R266	315-0152-00	B010100	B069999	RES, FXD, FILM: 1.5K OHM, 5%, 0.25W	57668	NTR25J-E01K5
R267	315-0152-00	B010100	B069999	RES, FXD, FILM: 1.5K OHM, 5%, 0.25W	57668	NTR25J-E01K5
R270	315-0391-00	B070000		RES, FXD, FILM: 390 OHM, 5%, 0.25W	57668	NTR25J-E390E
R271	315-0620-00	B070000		RES, FXD, FILM: 62 OHM, 5%, 0.25W	19701	5043CX63R00J
R273	317-0101-00	B010100	B069999	RES, FXD, CMPSN: 100 OHM, 5%, 0.125W	01121	BB1015
R273	315-0102-00	B070000		RES, FXD, FILM: 1K OHM, 5%, 0.25W	57668	NTR25JE01K0
R274	315-0102-00	B070000		RES, FXD, FILM: 1K OHM, 5%, 0.25W	57668	NTR25JE01K0
R275	317-0101-00	B010100	B069999	RES, FXD, CMPSN: 100 OHM, 5%, 0.125W	01121	BB1015
R276	315-0391-00	B070000		RES, FXD, FILM: 390 OHM, 5%, 0.25W	57668	NTR25J-E390E
R277	317-0101-00	B010100	B069999	RES, FXD, CMPSN: 100 OHM, 5%, 0.125W	01121	BB1015
R277	315-0361-00	B070000		RES, FXD, FILM: 360 OHM, 5%, 0.25W	19701	5043CX360R0J
R278	317-0101-00	B010100	B069999	RES, FXD, CMPSN: 100 OHM, 5%, 0.125W	01121	BB1015
R278	315-0391-00	B070000		RES, FXD, FILM: 390 OHM, 5%, 0.25W	57668	NTR25J-E390E
R279	315-0272-00	B010100	B069999	RES, FXD, FILM: 2.7K OHM, 5%, 0.25W	57668	NTR25J-E02K7

Component No.	Tektronix	Serial/Assembly No.		Name & Description	Mfr.	Mfr. Part No.
	Part No.	Effective	Discont		Code	
R279	315-0361-00	B070000		RES,FXD,FILM:360 OHM,5%,0.25W	19701	5043CX360R0J
R281	315-0271-00	B070000		RES,FXD,FILM:270 OHM,5%,0.25W	57668	NTR25J-E270E
R282	315-0241-00	B070000		RES,FXD,FILM:240 OHM,5%,0.25W	19701	5043CX240R0J
R283	315-0620-00	B070000		RES,FXD,FILM:62 OHM,5%,0.25W	19701	5043CX63R00J
R284	315-0752-00	B010100	B069999	RES,FXD,FILM:7.5K OHM,5%,0.25W	57668	NTR25J-E07K5
R284	315-0241-00	B070000		RES,FXD,FILM:240 OHM,5%,0.25W	19701	5043CX240R0J
R285	315-0362-00	B010100	B069999	RES,FXD,FILM:3.6K OHM,5%,0.25W	19701	5043CX3K600J
R285	315-0271-00	B070000		RES,FXD,FILM:270 OHM,5%,0.25W	57668	NTR25J-E270E
R286	315-0361-00	B010100	B069999	RES,FXD,FILM:360 OHM,5%,0.25W	19701	5043CX360R0J
R287	315-0361-00	B010100	B069999	RES,FXD,FILM:360 OHM,5%,0.25W	19701	5043CX360R0J
R287	315-0620-00	B070000		RES,FXD,FILM:62 OHM,5%,0.25W	19701	5043CX63R00J
R291	315-0471-00	B010100	B069999	RES,FXD,FILM:470 OHM,5%,0.25W	57668	NTR25J-E470E
R292	315-0621-00	B010100	B069999	RES,FXD,FILM:620 OHM,5%,0.25W	57668	NTR25J-E620E
R295	317-0510-00	B010100	B069999	RES,FXD,CMPSN:51 OHM,5%,0.125W	01121	BB5105
R296	315-0181-00	B010100	B069999	RES,FXD,FILM:180 OHM,5%,0.25W	57668	NTR25J-E180E
R297	315-0132-00	B010100	B069999	RES,FXD,FILM:1.3K OHM,5%,0.25W	57668	NTR25J-E01K3
R298	317-0510-00	B010100	B069999	RES,FXD,CMPSN:51 OHM,5%,0.125W	01121	BB5105
R302	315-0750-00	B010100	B069999	RES,FXD,FILM:75 OHM,5%,0.25W	57668	NTR25J-E75E0
R303	315-0121-00	B010100	B069999	RES,FXD,FILM:120 OHM,5%,0.25W	19701	5043CX120R0J
R311	317-0270-00	B010100	B069999	RES,FXD,CMPSN:27 OHM,5%,0.125W	01121	BB2705
R312	315-0510-00	B010100	B069999	RES,FXD,FILM:51 OHM,5%,0.25W	19701	5043CX51R00J
R313	315-0510-00	B010100	B069999	RES,FXD,FILM:51 OHM,5%,0.25W	19701	5043CX51R00J
R314	315-0100-00	B010100	B069999	RES,FXD,FILM:10 OHM,5%,0.25W	19701	5043CX10R00J
R315	315-0122-00	B010100	B069999	RES,FXD,FILM:1.2K OHM,5%,0.25W	57668	NTR25J-E01K2
R316	315-0112-00	B010100	B069999	RES,FXD,FILM:1.1K OHM,5%,0.25W	19701	5043CX1K100J
R317	315-0112-00	B010100	B069999	RES,FXD,FILM:1.1K OHM,5%,0.25W	19701	5043CX1K100J
R320	311-1224-00	B070000		RES,VAR,NONNW:TRMR,500 OHM,0.5W	32997	3386F-T04-501
R321	315-0391-00	B070000		RES,FXD,FILM:390 OHM,5%,0.25W	57668	NTR25J-E390E
R322	315-0131-00	B010100	B069999	RES,FXD,FILM:130 OHM,5%,0.25W	19701	5043CX130R0J
R322	315-0151-00	B070000		RES,FXD,FILM:150 OHM,5%,0.25W	57668	NTR25J-E150E
R323	315-0472-00	B070000		RES,FXD,FILM:4.7K OHM,5%,0.25W	57668	NTR25J-E04K7
R324	317-0240-00	B010100	B069999	RES,FXD,CMPSN:24 OHM,5%,0.125W	01121	BB2405
R324	315-0472-00	B070000		RES,FXD,FILM:4.7K OHM,5%,0.25W	57668	NTR25J-E04K7
R325	311-1258-00	B010100	B069999	RES,VAR,NONNW:TRMR,50 OHM,0.5W	32997	3329P-L58-500
R325	315-0220-00	B070000		RES,FXD,FILM:22 OHM,5%,0.25W	19701	5043CX22R00J
R326	315-0102-00	B070000		RES,FXD,FILM:1K OHM,5%,0.25W	57668	NTR25JE01K0
R327	321-0260-00	B070000		RES,FXD,FILM:4.99K OHM,1%,0.125W,TC=TO	19701	5033ED4K990F
R328	315-0472-00	B070000		RES,FXD,FILM:4.7K OHM,5%,0.25W	57668	NTR25J-E04K7
R329	321-0260-00	B070000		RES,FXD,FILM:4.99K OHM,1%,0.125W,TC=TO	19701	5033ED4K990F
R331	315-0102-00	B010100	B069999	RES,FXD,FILM:1K OHM,5%,0.25W	57668	NTR25JE01K0
R334	315-0562-00			RES,FXD,FILM:5.6K OHM,5%,0.25W	57668	NTR25J-E05K6
R335	315-0242-00	B010100	B069999	RES,FXD,FILM:2.4K OHM,5%,0.25W	57668	NTR25J-E02K4
R337	315-0682-00	B010100	B069999	RES,FXD,FILM:6.8K OHM,5%,0.25W	57668	NTR25J-E06K8
R340	315-0911-00	B070000		RES,FXD,FILM:910 OHM,5%,0.25W	57668	NTR25J-E910E
R342	315-0220-00	B010100	B069999	RES,FXD,FILM:22 OHM,5%,0.25W	19701	5043CX22R00J
R342	315-0151-00	B070000		RES,FXD,FILM:150 OHM,5%,0.25W	57668	NTR25J-E150E
R343	315-0112-00	B010100	B069999	RES,FXD,FILM:1.1K OHM,5%,0.25W	19701	5043CX1K100J
R343	315-0102-00	B070000		RES,FXD,FILM:1K OHM,5%,0.25W	57668	NTR25JE01K0
R345	311-1267-00	B010100	B069999	RES,VAR,NONNW:TRMR,5K OHM,0.5W	32997	3329P-L58-502
R346	315-0202-00	B010100	B069999	RES,FXD,FILM:2K OHM,5%,0.25W	57668	NTR25J-E 2K
R348	315-0271-00	B010100	B069999	RES,FXD,FILM:270 OHM,5%,0.25W	57668	NTR25J-E270E
R349	315-0471-00	B010100	B069999	RES,FXD,FILM:470 OHM,5%,0.25W	57668	NTR25J-E470E
R352	315-0220-00	B010100	B069999	RES,FXD,FILM:22 OHM,5%,0.25W	19701	5043CX22R00J
R353	315-0362-00	B010100	B069999	RES,FXD,FILM:3.6K OHM,5%,0.25W	19701	5043CX3K600J
R355	311-1267-00	B010100	B069999	RES,VAR,NONNW:TRMR,5K OHM,0.5W	32997	3329P-L58-502
R356	315-0202-00	B010100	B069999	RES,FXD,FILM:2K OHM,5%,0.25W	57668	NTR25J-E 2K
R358	315-0201-00	B010100	B069999	RES,FXD,FILM:200 OHM,5%,0.25W	57668	NTR25J-E200E
R359	315-0471-00	B010100	B069999	RES,FXD,FILM:470 OHM,5%,0.25W	57668	NTR25J-E470E

Replaceable Electrical Parts - 7892A

Component No.	Tektronix Part No.	Serial/Assembly No. Effective	Discnt	Name & Description	Mfr. Code	Mfr. Part No.
R360	321-0235-00	B070000		RES, FXD, FILM:2.74K OHM, 1%, 0.125W, TC=TO	07716	CEAD27400F
R361	321-0193-00	B070000		RES, FXD, FILM:1K OHM, 1%, 0.125W, TC=TO	19701	5033ED1K00F
R362	315-0201-00	B070000		RES, FXD, FILM:200 OHM, 5%, 0.25W	57668	NTR25J-E200E
R363	315-0360-00	B070000		RES, FXD, FILM:36 OHM, 5%, 0.25W	19701	5043CX36R00J
R366	315-0201-00	B070000		RES, FXD, FILM:200 OHM, 5%, 0.25W	57668	NTR25J-E200E
R367	321-0268-00	B070000		RES, FXD, FILM:6.04K OHM, 1%, 0.125W, TC=TO	19701	5043ED6K040F
R368	321-0160-00	B070000		RES, FXD, FILM:453 OHM, 1%, 0.125W, TC=TO	19701	5033ED453R0F
R371	317-0430-00	B010100	B069999	RES, FXD, CMPSN:43 OHM, 5%, 0.125W	01121	BB4305
R373	317-0101-00	B010100	B069999	RES, FXD, CMPSN:100 OHM, 5%, 0.125W	01121	BB1015
R375	317-0470-00	B010100	B069999	RES, FXD, CMPSN:47 OHM, 5%, 0.125W	01121	BB4705
R377	317-0510-00	B010100	B069999	RES, FXD, CMPSN:51 OHM, 5%, 0.125W	01121	BB5105
R378	315-0102-00	B010100	B029999	RES, FXD, FILM:1K OHM, 5%, 0.25W	57668	NTR25JE01K0
R383	315-0220-00	B010100	B039999	RES, FXD, FILM:22 OHM, 5%, 0.25W	19701	5043CX22R00J
R383	315-0101-00	B040000	B069999	RES, FXD, FILM:100 OHM, 5%, 0.25W	57668	NTR25J-E 100E
R384	315-0152-00	B040000	B069999	RES, FXD, FILM:1.5K OHM, 5%, 0.25W	57668	NTR25J-E01K5
R385	315-0102-00	B010100	B069999	RES, FXD, FILM:1K OHM, 5%, 0.25W	57668	NTR25JE01K0
R386	321-0232-00	B010100	B039999	RES, FXD, FILM:2.55K OHM, 1%, 0.125W, TC=TO	19701	5043ED2K550F
R386	321-0229-00	B040000	B069999	RES, FXD, FILM:2.37K OHM, 1%, 0.125W, TC=TO	19701	5043ED2K37F
R387	315-0360-00	B010100	B069999	RES, FXD, FILM:36 OHM, 5%, 0.25W	19701	5043CX36R00J
R388	321-0251-00	B010100	B039999	RES, FXD, FILM:4.02K OHM, 1%, 0.125W, TC=TO	19701	5033ED4K020F
R388	321-0248-00	B040000	B069999	RES, FXD, FILM:3.74K OHM, 1%, 0.125W, TC=TO	19701	5043ED3K740F
R401	315-0100-00			RES, FXD, FILM:10 OHM, 5%, 0.25W	19701	5043CX10R00J
R402	321-0207-00			RES, FXD, FILM:1.40K OHM, 1%, 0.125W, TC=TO	19701	5033ED1K400F
R403	315-0102-00			RES, FXD, FILM:1K OHM, 5%, 0.25W	57668	NTR25JE01K0
R404	315-0332-00			RES, FXD, FILM:3.3K OHM, 5%, 0.25W	57668	NTR25J-E03K3
R405	315-0151-00			RES, FXD, FILM:150 OHM, 5%, 0.25W	57668	NTR25J-E150E
R406	315-0470-00			RES, FXD, FILM:47 OHM, 5%, 0.25W	57668	NTR25J-E47E0
R408	315-0332-00			RES, FXD, FILM:3.3K OHM, 5%, 0.25W	57668	NTR25J-E03K3
R409	315-0101-00			RES, FXD, FILM:100 OHM, 5%, 0.25W	57668	NTR25J-E 100E
R411	315-0101-00	B010100	B069999	RES, FXD, FILM:100 OHM, 5%, 0.25W	57668	NTR25J-E 100E
R411	315-0510-00	B070000		RES, FXD, FILM:51 OHM, 5%, 0.25W	19701	5043CX51R00J
R412	323-0173-00			RES, FXD, FILM:619 OHM, 1%, 0.5W, TC=TO	19701	5053RD619R0F
R414	315-0101-00			RES, FXD, FILM:100 OHM, 5%, 0.25W	57668	NTR25J-E 100E
R415	315-0101-00			RES, FXD, FILM:100 OHM, 5%, 0.25W	57668	NTR25J-E 100E
R421	315-0560-00			RES, FXD, FILM:56 OHM, 5%, 0.25W	57668	NTR25J-E56E0
R422	315-0560-00			RES, FXD, FILM:56 OHM, 5%, 0.25W	57668	NTR25J-E56E0
R423	321-0275-00			RES, FXD, FILM:7.15K OHM, 1%, 0.125W, TC=TO	07716	CEAD71500F
R425	311-1245-00			RES, VAR, NONWW:TRMR, 10K OHM, 0.5W	32997	3386X-DY6-103
R426	315-0103-00			RES, FXD, FILM:10K OHM, 5%, 0.25W	19701	5043CX10K00J
R427	315-0470-00			RES, FXD, FILM:47 OHM, 5%, 0.25W	57668	NTR25J-E47E0
R429	321-0173-00			RES, FXD, FILM:619 OHM, 1%, 0.125W, TC=TO	07716	CEAD619R0F
R430	315-0161-00			RES, FXD, FILM:160 OHM, 5%, 0.25W	57668	NTR25J-E 160E
R431	321-0047-00			RES, FXD, FILM:30.1 OHM, 1%, 0.125W, TC=TO	91637	CMF55116630R10F
R432	315-0330-00			RES, FXD, FILM:33 OHM, 5%, 0.25W	19701	5043CX33R00J
R433	315-0221-00			RES, FXD, FILM:220 OHM, 5%, 0.25W	57668	NTR25J-E220E
R436	315-0101-00			RES, FXD, FILM:100 OHM, 5%, 0.25W	57668	NTR25J-E 100E
R438	315-0221-00			RES, FXD, FILM:220 OHM, 5%, 0.25W	57668	NTR25J-E220E
R440	315-0470-00			RES, FXD, FILM:47 OHM, 5%, 0.25W	57668	NTR25J-E47E0
R441	315-0330-00			RES, FXD, FILM:33 OHM, 5%, 0.25W	19701	5043CX33R00J
R442	315-0510-00			RES, FXD, FILM:51 OHM, 5%, 0.25W	19701	5043CX51R00J
R443	315-0823-00			RES, FXD, FILM:82K OHM, 5%, 0.25W	57668	NTR25J-E82K
R444	315-0560-00			RES, FXD, FILM:56 OHM, 5%, 0.25W	57668	NTR25J-E56E0
R445	315-0101-00			RES, FXD, FILM:100 OHM, 5%, 0.25W	57668	NTR25J-E 100E
R446	315-0470-00			RES, FXD, FILM:47 OHM, 5%, 0.25W	57668	NTR25J-E47E0
R447	315-0271-00			RES, FXD, FILM:270 OHM, 5%, 0.25W	57668	NTR25J-E270E
R450	315-0152-00			RES, FXD, FILM:1.5K OHM, 5%, 0.25W	57668	NTR25J-E01K5
R451	315-0470-00			RES, FXD, FILM:47 OHM, 5%, 0.25W	57668	NTR25J-E47E0
R452	315-0204-00	B010100	B098279	RES, FXD, FILM:200K OHM, 5%, 0.25W	19701	5043CX200K0J

Component No.	Tektronix Part No.	Serial/Assembly No. Effective	Discont	Name & Description	Mfr. Code	Mfr. Part No.
R452	315-0474-00	B098280		RES,FXD,FILM:470K OHM,5%,0.25W	19701	5043CX470K0J92U
R453	321-0306-00			RES,FXD,FILM:15.0K OHM,1%,0.125W,TC=TO	19701	5033ED15J00F
R454	321-0260-00			RES,FXD,FILM:4.99K OHM,1%,0.125W,TC=TO	19701	5033ED4K990F
R455	321-0262-00			RES,FXD,FILM:5.23K OHM,1,0.125W,TC=TO	19701	5033ED5K230F
R456	315-0510-00			RES,FXD,FILM:51 OHM,5%,0.25W	19701	5043CX51R00J
R457	315-0431-00			RES,FXD,FILM:430 OHM,5%,0.25W	19701	5043CX430R0J
R458	311-1501-00			RES,VAR,NONWV:TRMR,20 OHM,0.5W	32997	3386 X-T07-200
R459	315-0242-00			RES,FXD,FILM:2.4K OHM,5%,0.25W	57668	NTR25J-E02K4
R460	315-0102-00			RES,FXD,FILM:1K OHM,5%,0.25W	57668	NTR25JE01K0
R461	315-0910-00			RES,FXD,FILM:91 OHM,5%,0.25W	19701	5043CX91R00J
R462	315-0101-00			RES,FXD,FILM:100 OHM,5%,0.25W	57668	NTR25J-E 100E
R463	315-0272-00			RES,FXD,FILM:2.7K OHM,5%,0.25W	57668	NTR25J-E02K7
R464	315-0751-00			RES,FXD,FILM:750 OHM,5%,0.25W	57668	NTR25J-E750E
R465	321-0196-00			RES,FXD,FILM:1.07K OHM,1%,0.125W,TC=TO	07716	CEAD10700F
R466	321-0222-00			RES,FXD,FILM:2.00K OHM,1%,0.125W,TC=TO	19701	5033ED2K00F
R467	315-0221-00			RES,FXD,FILM:220 OHM,5%,0.25W	57668	NTR25J-E220E
R468	321-0183-00			RES,FXD,FILM:787 OHM,1%,0.125W,TC=TO	07716	CEAD787R0F
R469	321-0124-00			RES,FXD,FILM:191 OHM,1%,0.125W, TC=TO	07716	CEAD191R0F
R470	315-0820-00			RES,FXD,FILM:82 OHM,5%,0.25W	57668	NTR25J-E82E0
R471	315-0472-00			RES,FXD,FILM:4.7K OHM,5%,0.25W	57668	NTR25J-E04K7
R472	315-0102-00			RES,FXD,FILM:1K OHM,5%,0.25W	57668	NTR25JE01K0
R473	315-0510-00	B010100	B059999	RES,FXD,FILM:51 OHM,5%,0.25W	19701	5043CX51R00J
R474	315-0270-00	B010100	B059999	RES,FXD,FILM:27 OHM,5%,0.25W	19701	5043CX27R00J
R474	315-0101-00	B060000		RES,FXD,FILM:100 OHM,5%,0.25W	57668	NTR25J-E 100E
R475	315-0202-00			RES,FXD,FILM:2K OHM,5%,0.25W	57668	NTR25J-E 2K
R476	315-0101-00			RES,FXD,FILM:100 OHM,5%,0.25W	57668	NTR25J-E 100E
R477	315-0101-00			RES,FXD,FILM:100 OHM,5%,0.25W	57668	NTR25J-E 100E
R478	315-0471-00			RES,FXD,FILM:470 OHM,5%,0.25W	57668	NTR25J-E470E
R479	315-0911-00			RES,FXD,FILM:910 OHM,5%,0.25W	57668	NTR25J-E910E
R480	321-0204-00	B010100	B069999	RES,FXD,FILM:1.30K OHM,1%,0.125W,TC=TO	19701	5033ED1K300F
R480	321-0256-00	B070000		RES,FXD,FILM:4.53K OHM,1%,0.125W,TC=T9	19701	5033ED4K530F
R481	315-0101-00			RES,FXD,FILM:100 OHM,5%,0.25W	57668	NTR25J-E 100E
R483	315-0470-00	B010100	B069999	RES,FXD,FILM:47 OHM,5%,0.25W	57668	NTR25J-E47E0
R483	315-0100-00	B070000		RES,FXD,FILM:10 OHM,5%,0.25W	19701	5043CX10RR00J
R484	315-0561-00			RES,FXD,FILM:560 OHM,5%,0.25W	19701	5043CX560R0J
R485	315-0470-00			RES,FXD,FILM:47 OHM,5%,0.25W	57668	NTR25J-E47E0
R486	315-0221-00			RES,FXD,FILM:220 OHM,5%,0.25W	57668	NTR25J-E220E
R487	321-0193-00			RES,FXD,FILM:1K OHM,1%,0.125W,TC=TO	19701	5033ED1K00F
R488	321-0193-00			RES,FXD,FILM:1K OHM,1%,0.125W,TC=TO	19701	5033ED1K00F
R489	321-0219-00			RES,FXD,FILM:1.87K OHM,1%,0.125W,TC=TO	07716	CEAD18700F
R490	311-0946-00			RES,VAR,WV:TRMR,50K OHM,2W	02111	534-0070
R491	321-0097-00			RES,FXD,FILM:100 OHM,1%,0.125W,TC=TO	91637	CMF55116G100ROF
R494	315-0102-00			RES,FXD,FILM:1K OHM,5%,0.25W	57668	NTR25JE01K0
R495	311-1239-00			RES,VAR,NONWV:TRMR,2.5K OHM,0.5W	32997	3386X-T07-252
R496	321-0341-00	B010100	B029999	RES,FXD,FILM:34.8K OHM,1%,0.125W,TC=TO	19701	5043ED34K80F
R496	321-0342-00	B030000		RES,FXD,FILM:35.7K OHM,1%,0.125W,TC=TO	07716	CEAD35701F
R497	321-0816-03			RES,FXD,FILM:5K OHM,0.25%,0.125W,TC=T2	19701	5033RC5K000C
R498	315-0122-00			RES,FXD,FILM:1.2K OHM,5%,0.25W	57668	NTR25J-E01K2
R499	315-0821-00			RES,FXD,FILM:820 OHM,5%,0.25W	19701	5043CX820R0J
R501	315-0390-00			RES,FXD,FILM:39 OHM,5%,0.25W	57668	NTR25J-E39E0
R502	321-0207-00	B010100	B069999	RES,FXD,FILM:1.40K OHM,1%,0.125W,TC=TO	19701	5033ED1K400F
R502	321-0197-00	B070000		RES,FXD,FILM:1.10K OHM,1%,0.125W,TC=TO	07716	CEAD11000F
R504	315-0332-00	B010100	B069999	RES,FXD,FILM:3.3K OHM,5%,0.25W	57668	NTR25J-E03K3
R504	315-0301-00	B070000		RES,FXD,FILM:300 OHM,5%,0.25W	57668	NTR25J-E300E
R505	315-0151-00	B010100	B069999	RES,FXD,FILM:150 OHM,5%,0.25W	57668	NTR25J-E150E
R505	315-0821-00	B070000		RES,FXD,FILM:820 OHM,5%,0.25W	19701	5043CX820R0J
R506	315-0470-00			RES,FXD,FILM:47 OHM,5%,0.25W	57668	NTR25J-E47E0
R509	315-0101-00			RES,FXD,FILM:100 OHM,5%,0.25W	57668	NTR25J-E 100E

Replaceable Electrical Parts - 7B92A

Component No.	Tektronix Part No.	Serial/Assembly No.		Name & Description	Mfr. Code	Mfr. Part No.
		Effective	Discnt			
R511	315-0101-00			RES,FXD,FILM:100 OHM,5%,0.25W	57668	NTR25J-E 100E
R512	323-0173-00			RES,FXD,FILM:619 OHM,1%,0.5W,TC=TO	19701	5053RD619ROF
R514	315-0101-00			RES,FXD,FILM:100 OHM,5%,0.25W	57668	NTR25J-E 100E
R515	315-0101-00			RES,FXD,FILM:100 OHM,5%,0.25W	57668	NTR25J-E 100E
R521	321-0275-00			RES,FXD,FILM:7.15K OHM,1%,0.125W,TC=TO	07716	CEAD71500F
R525	311-1245-00			RES,VAR,NONNW:TRMR,10K OHM,0.5W	32997	3386X-DY6-103
R526	315-0682-00			RES,FXD,FILM:6.8K OHM,5%,0.25W	57668	NTR25J-E06K8
R527	315-0470-00			RES,FXD,FILM:47 OHM,5%,0.25W	57668	NTR25J-E47E0
R528	315-0100-00			RES,FXD,FILM:10 OHM,5%,0.25W	19701	5043CX10R00J
R529	321-0200-00			RES,FXD,FILM:1.18K OHM,1%,0.125W,TC=TO	19701	5033ED11K80F
R531	321-0076-00			RES,FXD,FILM:60.4 OHM,1%,0.125W,TC=TO	91637	CMF551166OR40F
R532	315-0300-00			RES,FXD,FILM:30 OHM,5%,0.25W	19701	5043CX30R00J
R536	315-0101-00			RES,FXD,FILM:100 OHM,5%,0.25W	57668	NTR25J-E 100E
R538	315-0221-00			RES,FXD,FILM:220 OHM,5%,0.25W	57668	NTR25J-E220E
R541	315-0330-00			RES,FXD,FILM:33 OHM,5%,0.25W	19701	5043CX33R00J
R542	315-0510-00			RES,FXD,FILM:51 OHM,5%,0.25W	19701	5043CX51R00J
R544	315-0560-00			RES,FXD,FILM:56 OHM,5%,0.25W	57668	NTR25J-E56E0
R545	315-0470-00			RES,FXD,FILM:47 OHM,5%,0.25W	57668	NTR25J-E47E0
R546	315-0470-00			RES,FXD,FILM:47 OHM,5%,0.25W	57668	NTR25J-E47E0
R547	315-0101-00			RES,FXD,FILM:100 OHM,5%,0.25W	57668	NTR25J-E 100E
R548	315-0470-00			RES,FXD,FILM:47 OHM,5%,0.25W	57668	NTR25J-E47E0
R551	315-0470-00			RES,FXD,FILM:47 OHM,5%,0.25W	57668	NTR25J-E47E0
R552	315-0152-00			RES,FXD,FILM:1.5K OHM,5%,0.25W	57668	NTR25J-E01K5
R553	315-0102-00			RES,FXD,FILM:1K OHM,5%,0.25W	57668	NTR25JE01K0
R554	315-0102-00			RES,FXD,FILM:1K OHM,5%,0.25W	57668	NTR25JE01K0
R557	321-0773-03			RES,FXD,FILM:400 OHM,0.25%,0.125W,TC=T2	19701	5033RC400ROC
R558	321-0773-03			RES,FXD,FILM:400 OHM,0.25%,0.125W,TC=T2	19701	5033RC400ROC
R559	315-0181-00			RES,FXD,FILM:180 OHM,5%,0.25W	57668	NTR25J-E180E
R561	315-0272-00			RES,FXD,FILM:2.7K OHM,5%,0.25W	57668	NTR25J-E02K7
R562	315-0101-00			RES,FXD,FILM:100 OHM,5%,0.25W	57668	NTR25J-E 100E
R563	315-0432-00			RES,FXD,FILM:4.3K OHM,5%,0.25W	57668	NTR25J-E04K3
R564	315-0471-00			RES,FXD,FILM:470 OHM,5%,0.25W	57668	NTR25J-E470E
R565	315-0391-00			RES,FXD,FILM:390 OHM,5%,0.25W	57668	NTR25J-E390E
R566	315-0132-00			RES,FXD,FILM:1.3K OHM,5%,0.25W	57668	NTR25J-E01K3
R568	315-0820-00			RES,FXD,FILM:82 OHM,5%,0.25W	57668	NTR25J-E82E0
R569	315-0202-00			RES,FXD,FILM:2K OHM,5%,0.25W	57668	NTR25J-E 2K
R571	315-0472-00			RES,FXD,FILM:4.7K OHM,5%,0.25W	57668	NTR25J-E04K7
R572	315-0102-00			RES,FXD,FILM:1K OHM,5%,0.25W	57668	NTR25JE01K0
R573	315-0510-00			RES,FXD,FILM:51 OHM,5%,0.25W	19701	5043CX51R00J
R574	315-0270-00			RES,FXD,FILM:27 OHM,5%,0.25W	19701	5043CX27R00J
R577	315-0101-00			RES,FXD,FILM:100 OHM,5%,0.25W	57668	NTR25J-E 100E
R578	315-0471-00			RES,FXD,FILM:470 OHM,5%,0.25W	57668	NTR25J-E470E
R579	315-0242-00			RES,FXD,FILM:2.4K OHM,5%,0.25W	57668	NTR25J-E02K4
R581	315-0102-00			RES,FXD,FILM:1K OHM,5%,0.25W	57668	NTR25JE01K0
R582	315-0752-00			RES,FXD,FILM:7.5K OHM,5%,0.25W	57668	NTR25J-E07K5
R585	315-0472-00			RES,FXD,FILM:4.7K OHM,5%,0.25W	57668	NTR25J-E04K7
R586	315-0510-00			RES,FXD,FILM:51 OHM,5%,0.25W	19701	5043CX51R00J
R600	311-1162-00	B010100	B098500	RES,VAR,NONNW:PNL,2 X 10K OHM,1W	12697	D381-CM 39691
R600	311-2315-00	B098501		RES,VAR,NONNW:(2)10K,10%,0.5W	12697	CM45209
R601	315-0273-00	B060000		RES,FXD,FILM:27K OHM,5%,0.25W	57668	NTR25J-E27K0
R602	315-0332-00	B010100	B059999	RES,FXD,FILM:3.3K OHM,5%,0.25W	57668	NTR25J-E03K3
R602	315-0302-00	B060000		RES,FXD,FILM:3K OHM,5%,0.25W	57668	NTR25J-E03K0
R603	315-0102-00			RES,FXD,FILM:1K OHM,5%,0.25W	57668	NTR25JE01K0
R605	-----			(PART OF R600)		
R606	315-0562-00			RES,FXD,FILM:5.6K OHM,5%,0.25W	57668	NTR25J-E05K6
R607	315-0102-00			RES,FXD,FILM:1K OHM,5%,0.25W	57668	NTR25JE01K0
R608	315-0102-00			RES,FXD,FILM:1K OHM,5%,0.25W	57668	NTR25JE01K0
R609	315-0102-00			RES,FXD,FILM:1K OHM,5%,0.25W	57668	NTR25JE01K0

Component No.	Tektronix Part No.	Serial/Assembly No. Effective	Discont	Name & Description	Mfr. Code	Mfr. Part No.
R613	315-0563-00			RES, FXD, FILM: 56K OHM, 5%, 0.25W	19701	5043CX56K00J
R615	311-0546-00			RES, VAR, NONW: TRMR, 10K OHM, 0.5W	01121	W-8154A
R616	315-0392-00			RES, FXD, FILM: 3.9K OHM, 5%, 0.25W	57668	NTR25J-E03K9
R631	315-0472-00	B060000		RES, FXD, FILM: 4.7K OHM, 5%, 0.25W	57668	NTR25J-E04K7
R632	315-0122-00	B060000		RES, FXD, FILM: 1.2K OHM, 5%, 0.25W	57668	NTR25J-E01K2
R633	315-0103-00	B060000		RES, FXD, FILM: 10K OHM, 5%, 0.25W	19701	5043CX10K00J
R634	315-0202-00	B060000		RES, FXD, FILM: 2K OHM, 5%, 0.25W	57668	NTR25J-E 2K
R635	315-0472-00	B060000		RES, FXD, FILM: 4.7K OHM, 5%, 0.25W	57668	NTR25J-E04K7
R701	315-0202-00			RES, FXD, FILM: 2K OHM, 5%, 0.25W	57668	NTR25J-E 2K
R702	315-0472-00			RES, FXD, FILM: 4.7K OHM, 5%, 0.25W	57668	NTR25J-E04K7
R711	315-0272-00			RES, FXD, FILM: 2.7K OHM, 5%, 0.25W	57668	NTR25J-E02K7
R712	315-0622-00			RES, FXD, FILM: 6.2K OHM, 5%, 0.25W	19701	5043CX6K200J
R713	315-0564-00			RES, FXD, FILM: 560K OHM, 5%, 0.25W	19701	5043CX560K0J
R714	315-0114-00			RES, FXD, FILM: 110K OHM, 5%, 0.25W	19701	5043CX110K0J
R715	315-0393-00			RES, FXD, FILM: 39K OHM, 5%, 0.25W	57668	NTR25J-E39K0
R731	323-1500-07			RES, FXD, FILM: 1.6MEG OHM, 0.1%, 0.5W, TC=T2	24546	NE65E1604B
R732	323-1500-07			RES, FXD, FILM: 1.6MEG OHM, 0.1%, 0.5W, TC=T2	24546	NE65E1604B
R733	323-0620-07			RES, FXD, FILM: 800K OHM, 0.1%, 0.5W, TC=T9	24546	NE65E8003B
R734	323-0806-07			RES, FXD, FILM: 266.7K OHM, 0.1%, 0.5W, TC=T9	91637	MFF1226C26672B
R735	323-1404-07			RES, FXD, FILM: 160K OHM, 0.1%, 0.5W, TC=T9	24546	NE65E1603B
R736	323-0805-07			RES, FXD, FILM: 80.0K OHM, 0.1%, 0.5W, TC=T9	24546	NE65E8002B
R737	323-0802-07			RES, FXD, FILM: 26.67K OHM, 0.1%, 0.5W, TC=T9	07716	CECE26671B
R738	323-1308-07			RES, FXD, FILM: 16.0K OHM, 0.1%, 0.5W, TC=T9	24546	NE65E1602B
R741	323-0810-07			RES, FXD, FILM: 4 MEG OHM, 0.1%, 0.5W, TC=T9	24546	NE65E4004B
R742	323-0810-07			RES, FXD, FILM: 4 MEG OHM, 0.1%, 0.5W, TC=T9	24546	NE65E4004B
R743	323-0510-07			RES, FXD, FILM: 2.0MEG OHM, 0.1%, 0.5W, TC=T9	91637	CMF65116-C20003B
R744	323-0808-07			RES, FXD, FILM: 666.7K OHM, 0.1%, 0.5W, TC=T9	19701	5053RE666K7B
R745	323-0807-07			RES, FXD, FILM: 400K OHM, 0.1%, 0.5W, TC=T9	19701	5053RE400K0B
R746	323-0414-07			RES, FXD, FILM: 200K OHM, 0.1%, 0.5W, TC=T9	19701	5053RE200K0B
R747	323-0804-07			RES, FXD, FILM: 66.67K OHM, 0.1%, 0.5W, TC=T9	19701	5053RE66K67B
R748	323-0803-07			RES, FXD, FILM: 40.0K OHM, 0.1%, 0.5W, TC=T9	19701	5053RE40K00B
R749	323-0318-00	B010100	B062409	RES, FXD, FILM: 20.0K OHM, 1%, 0.5W, TC=T0	91637	MFF1226D20001F
R749	323-0318-07	B062410		RES, FXD, FILM: 20K OHM, 0.1%, 0.5W, TC=T9	19701	5053RE25K00B
R750	311-0467-00			RES, VAR, NONW: PNL, 100K OHM, 0.5W	01121	W7705B
R751	321-0432-00			RES, FXD, FILM: 309K OHM, 1%, 0.125W, TC=T0	07716	CEAD30902F
R752	321-0366-00			RES, FXD, FILM: 63.4K OHM, 1%, 0.125W, TC=T0	19701	5043ED63K40F
R753	315-0121-00			RES, FXD, FILM: 120 OHM, 5%, 0.25W	19701	5043CX120R0J
R754	315-0562-00			RES, FXD, FILM: 5.6K OHM, 5%, 0.25W	57668	NTR25J-E05K6
R755	311-0959-00			RES, VAR, NONW: PNL, 10K OHM, 1.5W	71590	BA02510010
R756	321-0452-00	B010100	B029999	RES, FXD, FILM: 499K OHM, 1%, 0.125W, TC=T0	19701	5043ED499K0F
R756	321-0442-00	B030000		RES, FXD, FILM: 392K OHM, 1%, 0.125W, TC=T0	07716	CEAD39202F
R758	315-0133-00			RES, FXD, FILM: 13K OHM, 5%, 0.25W	19701	5043CX13K00J
R761	321-0400-00			RES, FXD, FILM: 143K OHM, 1%, 0.125W, TC=T0	19701	5043ED143K0F
R762	321-0371-00			RES, FXD, FILM: 71.5K OHM, 1%, 0.125W, TC=T0	07716	CEAD71501F
R763	321-0400-00			RES, FXD, FILM: 143K OHM, 1%, 0.125W, TC=T0	19701	5043ED143K0F
R764	321-0342-00			RES, FXD, FILM: 35.7K OHM, 1%, 0.125W, TC=T0	07716	CEAD35701F
R765	321-0400-00			RES, FXD, FILM: 143K OHM, 1%, 0.125W, TC=T0	19701	5043ED143K0F
R766	321-0371-00			RES, FXD, FILM: 71.5K OHM, 1%, 0.125W, TC=T0	07716	CEAD71501F
R770	315-0151-00			RES, FXD, FILM: 150 OHM, 5%, 0.25W	57668	NTR25J-E150E
R771	321-0400-00			RES, FXD, FILM: 143K OHM, 1%, 0.125W, TC=T0	19701	5043ED143K0F
R772	321-0371-00			RES, FXD, FILM: 71.5K OHM, 1%, 0.125W, TC=T0	07716	CEAD71501F
R773	321-0400-00			RES, FXD, FILM: 143K OHM, 1%, 0.125W, TC=T0	19701	5043ED143K0F
R774	321-0342-00			RES, FXD, FILM: 35.7K OHM, 1%, 0.125W, TC=T0	07716	CEAD35701F
R775	321-0400-00			RES, FXD, FILM: 143K OHM, 1%, 0.125W, TC=T0	19701	5043ED143K0F
R776	321-0371-00			RES, FXD, FILM: 71.5K OHM, 1%, 0.125W, TC=T0	07716	CEAD71501F
R781	315-0753-00			RES, FXD, FILM: 75K OHM, 5%, 0.25W	57668	NTR25J-E75K0
R782	315-0154-00			RES, FXD, FILM: 150K OHM, 5%, 0.25W	57668	NTR25J-E150K
R783	315-0513-00			RES, FXD, FILM: 51K OHM, 5%, 0.25W	57668	NTR25J-E51K0

Replaceable Electrical Parts - 7B92A

Component No.	Tektronix Part No.	Serial/Assembly No.		Name & Description	Mfr. Code	Mfr. Part No.
		Effective	Discont			
R784	321-0344-00			RES,FXD,FILM:37.4K OHM,1%,0.125W,TC=TO	19701	5033ED 37K40F
R785	315-0753-00			RES,FXD,FILM:75K OHM,5%,0.25W	57668	NTR25J-E75K0
R786	315-0154-00			RES,FXD,FILM:150K OHM,5%,0.25W	57668	NTR25J-E150K
R787	315-0154-00			RES,FXD,FILM:150K OHM,5%,0.25W	57668	NTR25J-E150K
R788	315-0513-00			RES,FXD,FILM:51K OHM,5%,0.25W	57668	NTR25J-E51K0
R789	321-0344-00			RES,FXD,FILM:37.4K OHM,1%,0.125W,TC=TO	19701	5033ED 37K40F
R791	315-0753-00			RES,FXD,FILM:75K OHM,5%,0.25W	57668	NTR25J-E75K0
R792	315-0154-00			RES,FXD,FILM:150K OHM,5%,0.25W	57668	NTR25J-E150K
R794	315-0753-00			RES,FXD,FILM:75K OHM,5%,0.25W	57668	NTR25J-E75K0
R795	315-0154-00			RES,FXD,FILM:150K OHM,5%,0.25W	57668	NTR25J-E150K
R796	315-0154-00			RES,FXD,FILM:150K OHM,5%,0.25W	57668	NTR25J-E150K
R798	315-0472-00			RES,FXD,FILM:4.7K OHM,5%,0.25W	57668	NTR25J-E04K7
R799	315-0332-00			RES,FXD,FILM:3.3K OHM,5%,0.25W	57668	NTR25J-E03K3
R801	315-0223-00			RES,FXD,FILM:22K OHM,5%,0.25W	19701	5043CX22K00J92U
R802	315-0391-00			RES,FXD,FILM:390 OHM,5%,0.25W	57668	NTR25J-E390E
R803	315-0202-00			RES,FXD,FILM:2K OHM,5%,0.25W	57668	NTR25J-E 2K
R806	321-0239-00			RES,FXD,FILM:3.01K OHM,1%,0.125W,TC=TO	19701	5043ED3K010F
R807	321-0193-00			RES,FXD,FILM:1K OHM,1%,0.125W,TC=TO	19701	5033ED1K00F
R811	315-0103-00			RES,FXD,FILM:10K OHM,5%,0.25W	19701	5043CX10K00J
R812	315-0473-00			RES,FXD,FILM:47K OHM,5%,0.25W	57668	NTR25J-E47K0
R813	315-0101-00			RES,FXD,FILM:100 OHM,5%,0.25W	57668	NTR25J-E 100E
R814	321-0257-00			RES,FXD,FILM:4.64K OHM,1%,0.125W,TC=TO	19701	5043ED4K640F
R816	315-0101-00			RES,FXD,FILM:100 OHM,5%,0.25W	57668	NTR25J-E 100E
R817	321-0212-00			RES,FXD,FILM:1.58K OHM,1%,0.125W,TC=70	19701	5033ED1K58F
R818	315-0103-00			RES,FXD,FILM:10K OHM,5%,0.25W	19701	5043CX10K00J
R819	315-0304-00			RES,FXD,FILM:300K OHM,5%,0.25W	57668	NTR25J-E300K
R822	315-0472-00			RES,FXD,FILM:4.7K OHM,5%,0.25W	57668	NTR25J-E04K7
R824	315-0622-00			RES,FXD,FILM:6.2K OHM,5%,0.25W	19701	5043CX6K200J
R826	315-0393-00			RES,FXD,FILM:39K OHM,5%,0.25W	57668	NTR25J-E39K0
R827	315-0472-00			RES,FXD,FILM:4.7K OHM,5%,0.25W	57668	NTR25J-E04K7
R828	315-0184-00			RES,FXD,FILM:180K OHM,5%,0.25W	19701	5043CX180K0J
R829	315-0241-00			RES,FXD,FILM:240 OHM,5%,0.25W	19701	5043CX240R0J
R831	315-0201-00			RES,FXD,FILM:200 OHM,5%,0.25W	57668	NTR25J-E200E
R832	315-0302-00			RES,FXD,FILM:3K OHM,5%,0.25W	57668	NTR25J-E03K0
R834	321-0310-00			RES,FXD,FILM:16.5K OHM,1%,0.125W,TC=TO	19701	5033ED16K50F
R839	315-0151-00			RES,FXD,FILM:150 OHM,5%,0.25W	57668	NTR25J-E150E
R841	315-0102-00			RES,FXD,FILM:1K OHM,5%,0.25W	57668	NTR25JE01K0
R842	315-0103-00			RES,FXD,FILM:10K OHM,5%,0.25W	19701	5043CX10K00J
R844	315-0220-00			RES,FXD,FILM:22 OHM,5%,0.25W	19701	5043CX22R00J
R845	315-0220-00			RES,FXD,FILM:22 OHM,5%,0.25W	19701	5043CX22R00J
R851	315-0222-00			RES,FXD,FILM:2.2K OHM,5%,0.25W	57668	NTR25J-E02K2
R852	315-0472-00			RES,FXD,FILM:4.7K OHM,5%,0.25W	57668	NTR25J-E04K7
R854	315-0102-00			RES,FXD,FILM:1K OHM,5%,0.25W	57668	NTR25JE01K0
R861	315-0680-00			RES,FXD,FILM:68 OHM,5%,0.25W	57668	NTR25J-E68E0
R862	315-0102-00			RES,FXD,FILM:1K OHM,5%,0.25W	57668	NTR25JE01K0
R863	315-0472-00			RES,FXD,FILM:4.7K OHM,5%,0.25W	57668	NTR25J-E04K7
R864	321-0136-00			RES,FXD,FILM:255 OHM,1%,0.125W,TC=TO	07716	CEAD255R0F
R865	315-0392-00			RES,FXD,FILM:3.9K OHM,5%,0.25W	57668	NTR25J-E03K9
R871	315-0102-00	B010100	B029999	RES,FXD,FILM:1K OHM,5%,0.25W	57668	NTR25JE01K0
R871	315-0272-00	B030000		RES,FXD,FILM:2.7K OHM,5%,0.25W	57668	NTR25J-E02K7
R872	315-0222-00			RES,FXD,FILM:2.2K OHM,5%,0.25W	57668	NTR25J-E02K2
R874	315-0102-00			RES,FXD,FILM:1K OHM,5%,0.25W	57668	NTR25JE01K0
R876	315-0102-00			RES,FXD,FILM:1K OHM,5%,0.25W	57668	NTR25JE01K0
R881	315-0471-00			RES,FXD,FILM:470 OHM,5%,0.25W	57668	NTR25J-E470E
R882	315-0202-00	B010100	B059999	RES,FXD,FILM:2K OHM,5%,0.25W	57668	NTR25J-E 2K
R882	315-0472-00	B060000		RES,FXD,FILM:4.7K OHM,5%,0.25W	57668	NTR25J-E04K7
R884	315-0270-00	B010100	B059999	RES,FXD,FILM:27 OHM,5%,0.25W	19701	5043CX27R00J
R885	315-0152-00			RES,FXD,FILM:1.5K OHM,5%,0.25W	57668	NTR25J-E01K5

Component No.	Tektronix	Serial/Assembly No.		Name & Description	Mfr.	Mfr. Part No.
	Part No.	Effective	Discont		Code	
R886	315-0510-00	B010100	B059999	RES,FXD,FILM:51 OHM,5%,0.25W	19701	5043CX51R00J
R888	315-0101-00			RES,FXD,FILM:100 OHM,5%,0.25W	57668	NTR25J-E 100E
R891	315-0102-00			RES,FXD,FILM:1K OHM,5%,0.25W	57668	NTR25JE01K0
R892	315-0272-00			RES,FXD,FILM:2.7K OHM,5%,0.25W	57668	NTR25J-E02K7
R893	315-0272-00			RES,FXD,FILM:2.7K OHM,5%,0.25W	57668	NTR25J-E02K7
R894	315-0272-00			RES,FXD,FILM:2.7K OHM,5%,0.25W	57668	NTR25J-E02K7
R895	315-0511-00			RES,FXD,FILM:510 OHM,5%,0.25W	19701	5043CX510R0J
R901	315-0272-00			RES,FXD,FILM:2.7K OHM,5%,0.25W	57668	NTR25J-E02K7
R902	315-0102-00			RES,FXD,FILM:1K OHM,5%,0.25W	57668	NTR25JE01K0
R903	315-0102-00			RES,FXD,FILM:1K OHM,5%,0.25W	57668	NTR25JE01K0
R905	315-0101-00			RES,FXD,FILM:100 OHM,5%,0.25W	57668	NTR25J-E 100E
R911	315-0272-00			RES,FXD,FILM:2.7K OHM,5%,0.25W	57668	NTR25J-E02K7
R912	315-0102-00			RES,FXD,FILM:1K OHM,5%,0.25W	57668	NTR25JE01K0
R915	315-0101-00			RES,FXD,FILM:100 OHM,5%,0.25W	57668	NTR25J-E 100E
R916	315-0182-00			RES,FXD,FILM:1.8K OHM,5%,0.25W	57668	NTR25J-E1K8
R921	315-0103-00			RES,FXD,FILM:10K OHM,5%,0.25W	19701	5043CX10K00J
R922	321-0266-00	B010100	B069999	RES,FXD,FILM:5.76K OHM,1%,0.125W,TC=TO	19701	5033ED5K760F
R922	321-0260-00	B070000		RES,FXD,FILM:4.99K OHM,1%,0.125W,TC=TO	19701	5033ED4K990F
R923	315-0151-00			RES,FXD,FILM:150 OHM,5%,0.25W	57668	NTR25J-E150E
R925	311-1248-00			RES,VAR,NONW:TRMR,500 OHM,0.5W	32997	3386X-T07-501
R926	321-0208-00			RES,FXD,FILM:1.43K OHM,1%,0.125W,TC=TO	19701	5033ED1K43F
R927	321-0228-00			RES,FXD,FILM:2.32K OHM,1%,0.125W,TC=TO	19701	5043ED2K32F
R929	321-0258-00	B010100	B029999	RES,FXD,FILM:4.75K OHM,1%,0.125W,TC=TO	19701	5033ED4K750F
R929	321-0256-00	B030000		RES,FXD,FILM:4.53K OHM,1%,0.125W,TC=T9	19701	5033ED4K530F
R930	311-1482-00	B010100	B094901	RES,VAR,NONW:PNL,5K OHM,0.5W	01121	W-8070
R930	311-1607-00	B094902		RES,VAR,NONW:PNL,5K OHM,20%,0.5W	01121	TYPE W
R932	321-0343-00			RES,FXD,FILM:36.5K OHM,1%,0.125W,TC=TO	07716	CEAD36501F
R935	311-1198-00			RES,VAR,NONW:TRMR,20K OHM,0.5W	32997	3386X-T07-203
R936	321-0341-00			RES,FXD,FILM:34.8K OHM,1%,0.125W,TC=TO	19701	5043ED34K80F
R937	315-0332-00			RES,FXD,FILM:3.3K OHM,5%,0.25W	57668	NTR25J-E03K3
R938	321-0222-00			RES,FXD,FILM:2.00K OHM,1%,0.125W,TC=TO	19701	5033ED2K00F
R939	315-0911-00			RES,FXD,FILM:910 OHM,5%,0.25W	57668	NTR25J-E910E
R941	315-0152-00			RES,FXD,FILM:1.5K OHM,5%,0.25W	57668	NTR25J-E01K5
R942	315-0270-00			RES,FXD,FILM:27 OHM,5%,0.25W	19701	5043CX27R00J
R944	315-0361-00			RES,FXD,FILM:360 OHM,5%,0.25W	19701	5043CX360R0J
R945	322-0218-00			RES,FXD,FILM:1.82K OHM,1%,0.25W,TC=TO	75042	CEBT0-1821F
R947	315-0621-00			RES,FXD,FILM:620 OHM,5%,0.25W	57668	NTR25J-E620E
R951	321-0118-00	B010100	B029999	RES,FXD,FILM:165 OHM,1%,0.125W,TC=TO	07716	CEAD165R0F
R951	321-0954-03	B030000		RES,FXD,FILM:162.5 OHM,0.25%,0.125W,TC=T2	07716	CEA 162.50HM
R952	315-0330-00			RES,FXD,FILM:33 OHM,5%,0.25W	19701	5043CX33R00J
R954	315-0181-00			RES,FXD,FILM:180 OHM,5%,0.25W	57668	NTR25J-E180E
R955	322-0218-00			RES,FXD,FILM:1.82K OHM,1%,0.25W,TC=TO	75042	CEBT0-1821F
R957	315-0621-00			RES,FXD,FILM:620 OHM,5%,0.25W	57668	NTR25J-E620E
R961	315-0121-00			RES,FXD,FILM:120 OHM,5%,0.25W	19701	5043CX120R0J
R962	321-0206-00			RES,FXD,FILM:1.37K OHM,1%,0.125W,TC=TO	07716	CEAD13700F
R963	321-0152-00			RES,FXD,FILM:374 OHM,1%,0.125W,TC=TO	07716	CEAD374R0F
R964	321-0122-00			RES,FXD,FILM:182 OHM,1%,0.125W,TC=TO	19701	5033ED182R0F
R974	315-0100-00			RES,FXD,FILM:10 OHM,5%,0.25W	19701	5043CX10R00J
R975	315-0100-00			RES,FXD,FILM:10 OHM,5%,0.25W	19701	5043CX10R00J
R976	321-0289-00			RES,FXD,FILM:10.0K OHM,1%,0.125W,TC=TO	19701	5033ED10K0F
R977	321-0260-00			RES,FXD,FILM:4.99K OHM,1%,0.125W,TC=TO	19701	5033ED4K990F
R978	315-0221-00			RES,FXD,FILM:220 OHM,5%,0.25W	57668	NTR25J-E220E
S6	260-0721-00			SWITCH,REED:SPDT,35A TURN	12617	1152234160
S10	670-3271-00			CIRCUIT BD ASSY:SOURCE SW	80009	670-3271-00
S20	670-3272-00			CIRCUIT BD ASSY:COUPLING SW	80009	670-3272-00
S50	-----			(PART OF R50)		
S100	670-3270-00			CIRCUIT BD ASSY:TRIG MODE SW	80009	670-3270-00
S205	260-1132-00	B010100	B075849	SWITCH,PUSH:DPDT,1A,2BVDC,1 BUTTON	80009	260-1132-00

Replaceable Electrical Parts - 7B92A

Component No.	Tektronix Part No.	Serial/Assembly No. Effective	Discont	Name & Description	Mfr. Code	Mfr. Part No.
S205	260-1132-04	B075850		SWITCH,PUSH:DPDT,1A,28VDC,1 BUTTON	59821	2KAB0100001023
S210	260-1133-00			SWITCH,PUSH:DP,1A,25VDC,3 BUTTON	31918	ORDER BY DESC
S220	-----			(PART OF S210)		
S250	311-1322-00			RES,VAR,NONWV:PNL,5K OHM,1W,W/SW	12697	381-CM39701
S285	-----			(PART OF S210)		
S490	260-1309-00			SWITCH,SENS:SPDT,5A,250AC,MOM	01963	E63-10H
S700	263-1084-00			SW CAM ACTR AS:TIME/DIV OR DELAY TIME	80009	263-1084-00
S755	214-1136-00			ACTUATOR,SL SW:VARIABLE CAL	80009	214-1136-00
S800	260-0960-01			SWITCH,SLIDE:FORM Z,0.5A,120VDC,BLACK BTTN	10389	23-021-043
T250	120-0444-00			XFMR,TOROID:	80009	120-0444-00
T958	120-0444-00			XFMR,TOROID:	80009	120-0444-00
U44	156-0158-00	B070000		MICROCKT,LINEAR:DUAL OPNL AMPL	04713	MC1458P1/MC1458U
U64	155-0061-00	B010100	B069999	MICROCKT,LINEAR:CHANNEL SWITCH	80009	155-0061-00
U74	155-0061-00	B070000		MICROCKT,LINEAR:CHANNEL SWITCH	80009	155-0061-00
U84	155-0061-00	B010100	B069999	MICROCKT,LINEAR:CHANNEL SWITCH	80009	155-0061-00
U104	155-0061-00	B010100	B069999	MICROCKT,LINEAR:CHANNEL SWITCH	80009	155-0061-00
U122	155-0150-00	B070000		MICROCKT,DGTL:TRIGGER	80009	155-0150-00
U128	156-0158-00	B010100	B069999	MICROCKT,LINEAR:DUAL OPNL AMPL	04713	MC1458P1/MC1458U
U132	156-0158-00	B070000		MICROCKT,LINEAR:DUAL OPNL AMPL	04713	MC1458P1/MC1458U
U170	156-0644-00	B070000		MICROCKT,DGTL:CMOS,QUAD BILATERAL SW,CHK	04713	MC14066BCL
U240	156-0067-00	B010100	B069999	MICROCKT,LINEAR:OPNL AMPL,SEL	04713	MC1741CP1
U244	156-0158-00	B070000		MICROCKT,LINEAR:DUAL OPNL AMPL	04713	MC1458P1/MC1458U
U264	155-0061-00	B010100	B069999	MICROCKT,LINEAR:CHANNEL SWITCH	80009	155-0061-00
U274	155-0061-00	B070000		MICROCKT,LINEAR:CHANNEL SWITCH	80009	155-0061-00
U284	155-0061-00	B010100	B069999	MICROCKT,LINEAR:CHANNEL SWITCH	80009	155-0061-00
U304	155-0061-00	B010100	B069999	MICROCKT,LINEAR:CHANNEL SWITCH	80009	155-0061-00
U322	155-0150-00	B070000		MICROCKT,DGTL:TRIGGER	80009	155-0150-00
U492	156-0200-00			MICROCKT,LINEAR:OPNL AMPL	04713	MC1456P1
U635	156-0093-02	B060000		MICROCKT,DGTL:HEX INV BUFFER	18324	N7416(NB OR FB)
U752	156-0067-00			MICROCKT,LINEAR:OPNL AMPL,SEL	04713	MC1741CP1
U820	155-0049-01	B010100	B064489	MICROCKT,DGTL:W/LOCKOUT DSBL FCTN	80009	155-0049-01
U820	155-0049-02	B069940		MICROCKT,DGTL:SWEEP CNTRL,W/LOCKOUT DISABLE	80009	155-0049-02
U856	156-0118-03	B010100	B059999	MICROCKT,DGTL:1 DUAL J-K FF,BURN-IN	01295	SN74S112JP4
U856	156-0118-03	B060000		MICROCKT,DGTL:1 DUAL J-K FF,BURN-IN	01295	SN74S112JP4
U978	156-0067-00			MICROCKT,LINEAR:OPNL AMPL,SEL	04713	MC1741CP1
VR82	152-0195-00	B070000		SEMICOND DVC,DI:ZEN,SI,5.1V,5%,0.4W,DO-7	04713	SZ11755RL
VR86	152-0195-00	B070000		SEMICOND DVC,DI:ZEN,SI,5.1V,5%,0.4W,DO-7	04713	SZ11755RL
VR282	152-0195-00	B070000		SEMICOND DVC,DI:ZEN,SI,5.1V,5%,0.4W,DO-7	04713	SZ11755RL
VR286	152-0195-00	B070000		SEMICOND DVC,DI:ZEN,SI,5.1V,5%,0.4W,DO-7	04713	SZ11755RL
VR322	152-0166-00	B010100	B069999	SEMICOND DVC,DI:ZEN,SI,6.2V,5%,0.4W,DO-7	04713	SZ11738RL
VR420	152-0127-00			SEMICOND DVC,DI:ZEN,SI,7.5V,5%,0.4W,DO-7	14433	Z5347 (1N958B)
VR904	152-0055-00			SEMICOND DVC,DI:ZEN,SI,11V,5%,0.4W,DO-7	14433	Z5407
VR914	152-0055-00			SEMICOND DVC,DI:ZEN,SI,11V,5%,0.4W,DO-7	14433	Z5407
VR916	153-0030-00			SEMICOND DVC SE:ZENER,PR	04713	SZ6179
VR937	153-0030-00			SEMICOND DVC SE:ZENER,PR	04713	SZ6179

DIAGRAMS AND CIRCUIT BOARD ILLUSTRATIONS

Symbols and Reference Designators

Electrical components shown on the diagrams are in the following units unless noted otherwise:

- Capacitors = Values one or greater are in picofarads (pF).
Values less than one are in microfarads (μ F).
- Resistors = Ohms (Ω).

Graphic symbols and class designation letters are based on ANSI Standard Y32.2-1975.

Logic symbology is based on ANSI Y32.14-1973 in terms of positive logic. Logic symbols depict the logic function performed and may differ from the manufacturer's data.

The overline on a signal name indicates that the signal performs its intended function when it goes to the low state.

Abbreviations are based on ANSI Y1.1-1972.

Other ANSI standards that are used in the preparation of diagrams by Tektronix, Inc. are:

- Y14.15, 1966 Drafting Practices.
- Y14.2, 1973 Line Conventions and Lettering.
- Y10.5, 1968 Letter Symbols for Quantities Used in Electrical Science and Electrical Engineering.

The following prefix letters are used as reference designators to identify components or assemblies on the diagrams.

A	Assembly, separable or repairable (circuit board, etc)	H	Heat dissipating device (heat sink, heat radiator, etc)	S	Switch or contactor
AT	Attenuator, fixed or variable	HR	Heater	T	Transformer
B	Motor	HY	Hybrid circuit	TC	Thermocouple
BT	Battery	J	Connector, stationary portion	TP	Test point
C	Capacitor, fixed or variable	K	Relay	U	Assembly, inseparable or non-repairable (integrated circuit, etc.)
CB	Circuit breaker	L	Inductor, fixed or variable	V	Electron tube
CR	Diode, signal or rectifier	M	Meter	VR	Voltage regulator (zener diode, etc.)
DL	Delay line	P	Connector, movable portion	W	Wirestrap or cable
DS	Indicating device (lamp)	Q	Transistor or silicon-controlled rectifier	Y	Crystal
E	Spark Gap, Ferrite bead	R	Resistor, fixed or variable	Z	Phase shifter
F	Fuse	RT	Thermistor		
FL	Filter				

The following special symbols may appear on the diagrams:

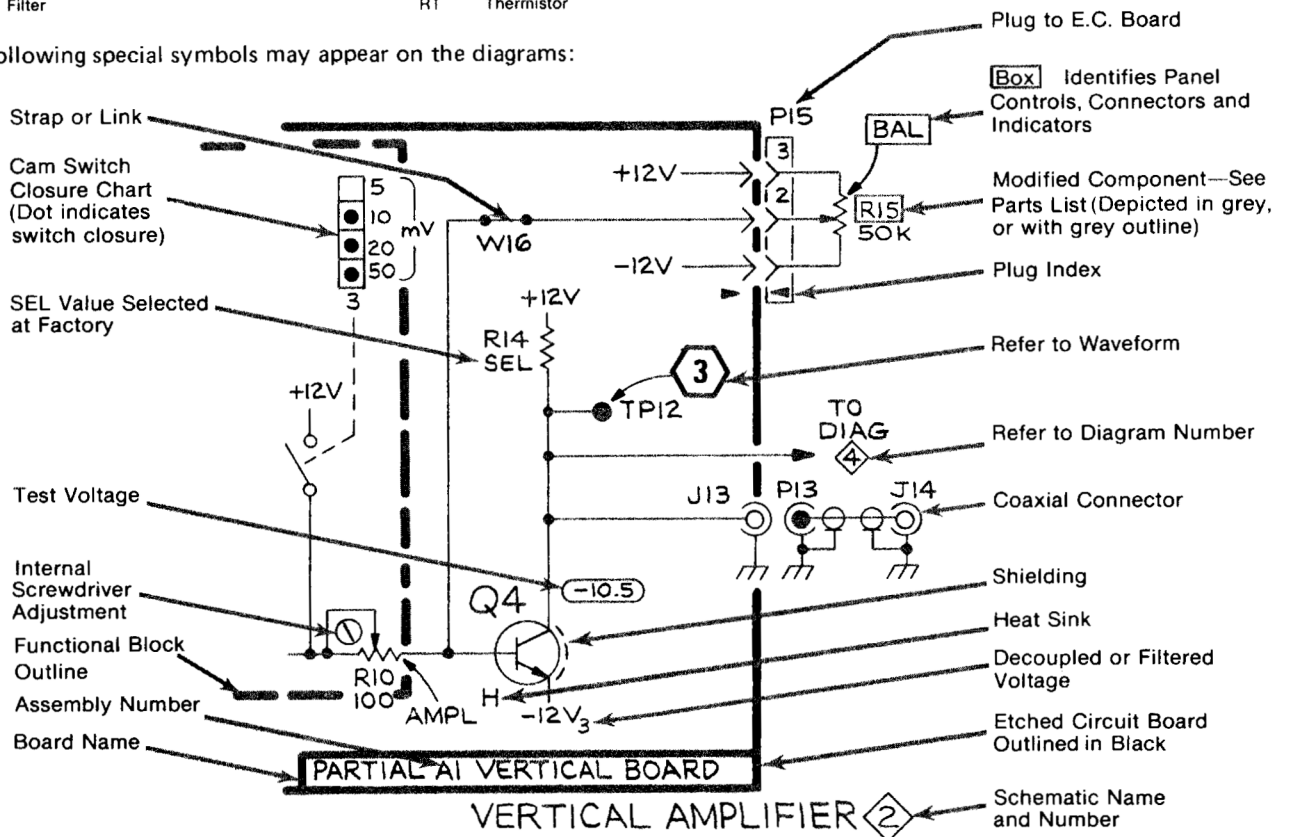

VOLTAGE AND WAVEFORM CONDITIONS

WARNING

Dangerous potentials exist at several points throughout this instrument. When the instrument is operated with the covers removed, do not touch exposed connections or components. Some transistors have voltages present on their cases. Disconnect the power source before replacing parts.

The voltages and waveforms shown on diagrams were taken with the 7B92A front panel controls set as follows:

VOLTAGES & WAVEFORMS*

MAIN TRIGGERING		Delayed Triggering	
MODE	AUTO	SLOPE	+
COUPLING	AC	COUPLING	AC
SOURCE	INT	SOURCE	INT
LEVEL	0	LEVEL	0
SLOPE	+		
Sweep Controls		Inputs	
POSITION	Midrange	TERM	IN 1 MΩ
TIME/DIV OR DLY TIME	1 ms		
DLY'D TIME/ DIVISION	0.5 ms/ PULL FOR ALT		
TRACE SEP	Fully clockwise		
DELAY TIME MULT	1.0		

*Ground Reference: center horizontal graticule line (Main Trigger and DELAYED Trigger).

Voltage Conditions. The voltage measurements were taken under the following conditions:

A four-volt calibrator signal was applied to the vertical amplifier plug-in unit; the amplifier was set for a two-division display.

A digital multimeter with a 10 megohm input impedance, accuracy 0.1% (TEKTRONIX DM 501 Digital Multimeter was used with readout equipped, 7000-series oscilloscope).

Waveform Conditions. The waveforms shown were obtained using a test oscilloscope system with 10 megohm input impedance and at least 65 megahertz bandwidth (TEKTRONIX 7603 Oscilloscope, 7B53A Time Base, and 7A26 Amplifier equipped with 10X probe).

The waveforms shown are actual waveform photographs taken with a Tektronix Oscilloscope Camera System and Projected Graticule. Vertical deflection factor shown on the waveform is the actual deflection factor from the probe tip. Voltages and waveforms on the diagrams are not absolute and may vary between instruments because of component tolerances, internal calibration, or front-panel settings. Readouts are simulated in larger-than-normal type.

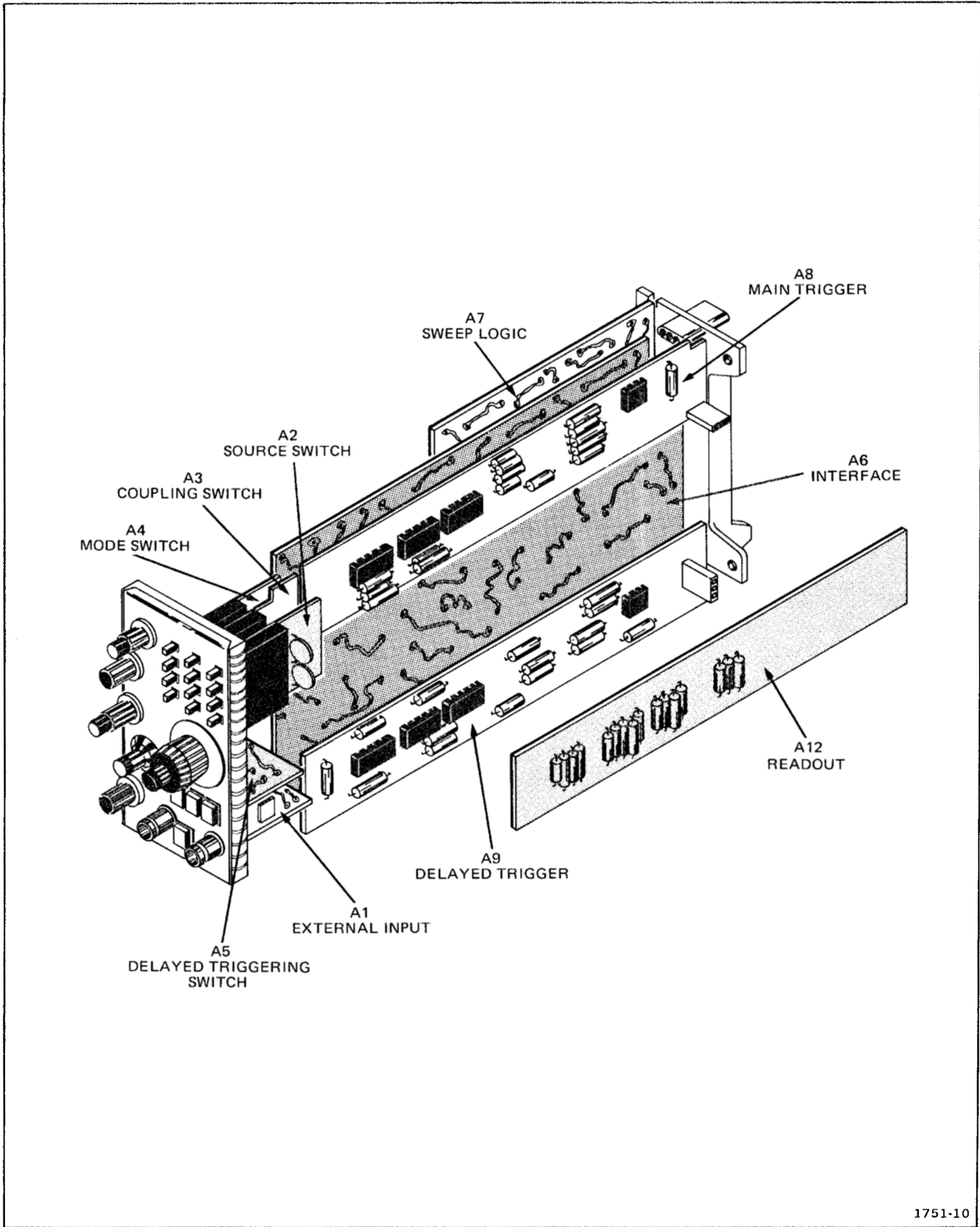

Fig. 8-1. Circuit Board Locations.

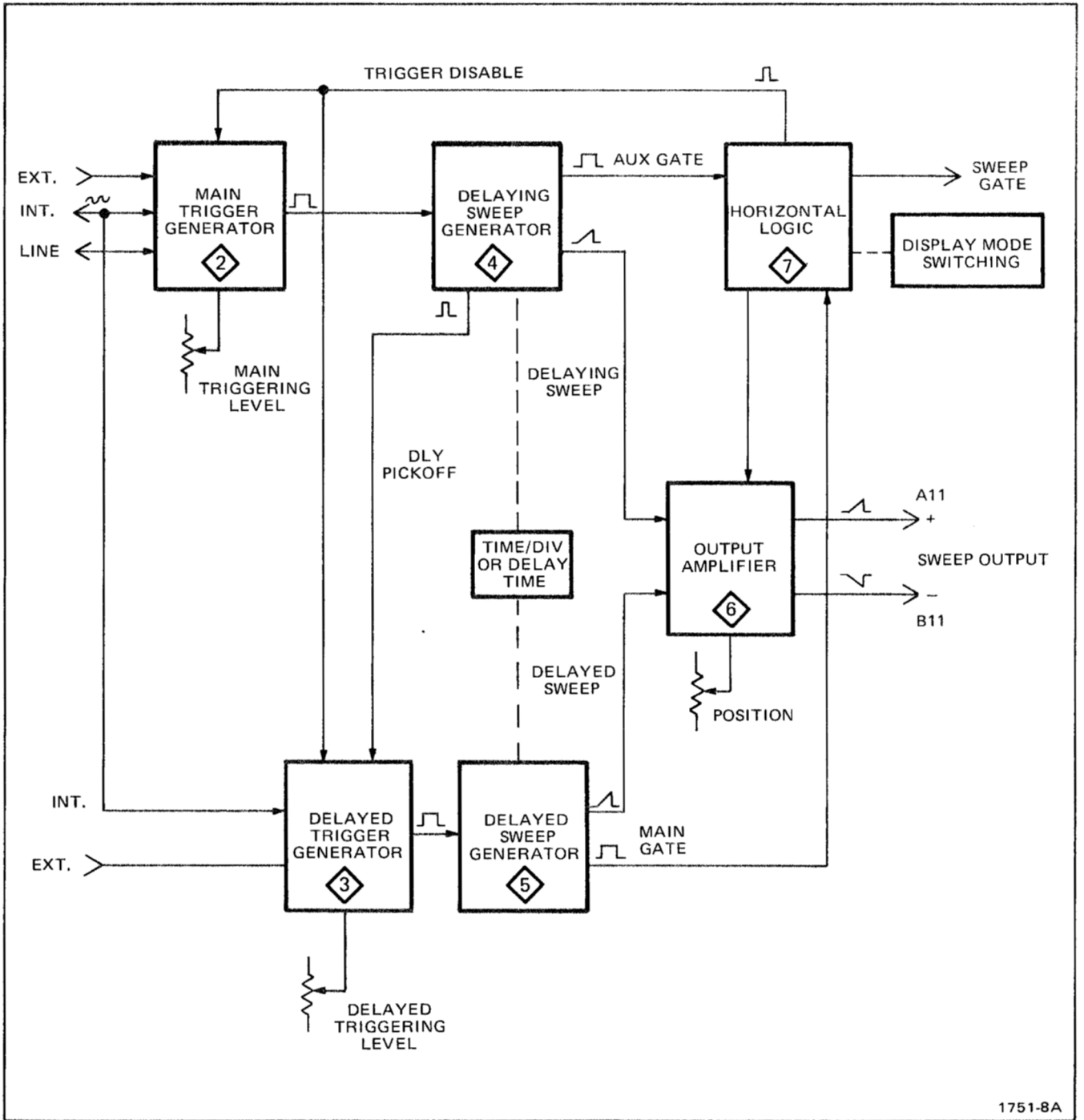

Fig. 8-2. Block Diagram.

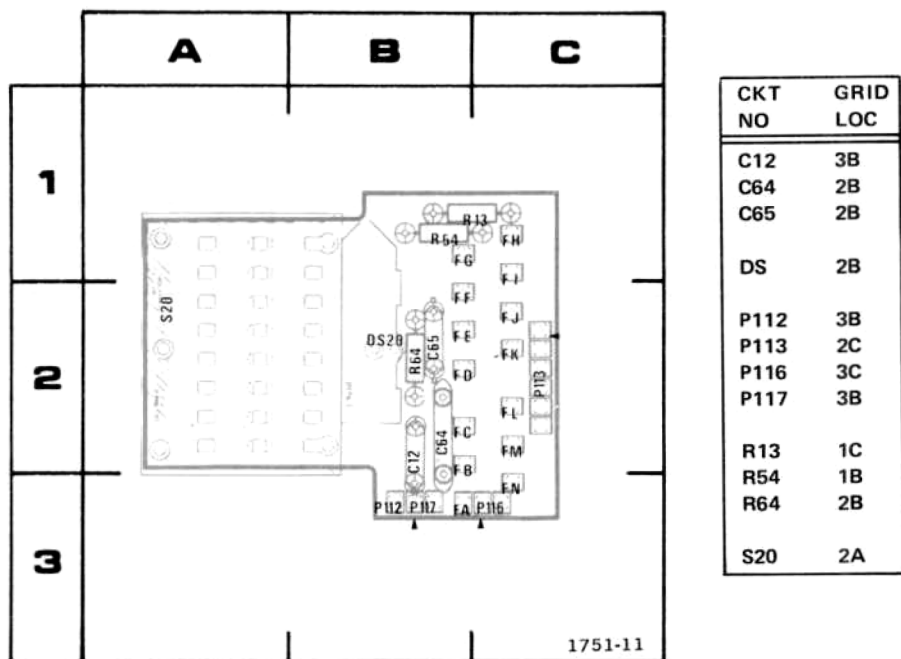

Fig. 8-3. A3—Coupling Switch Circuit Board.

REV. B JUN 1978

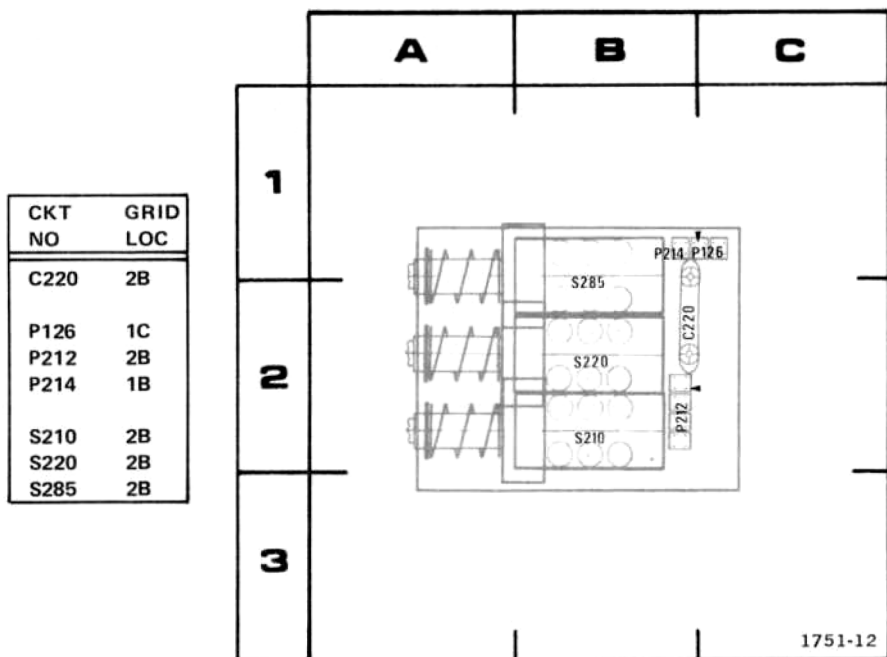
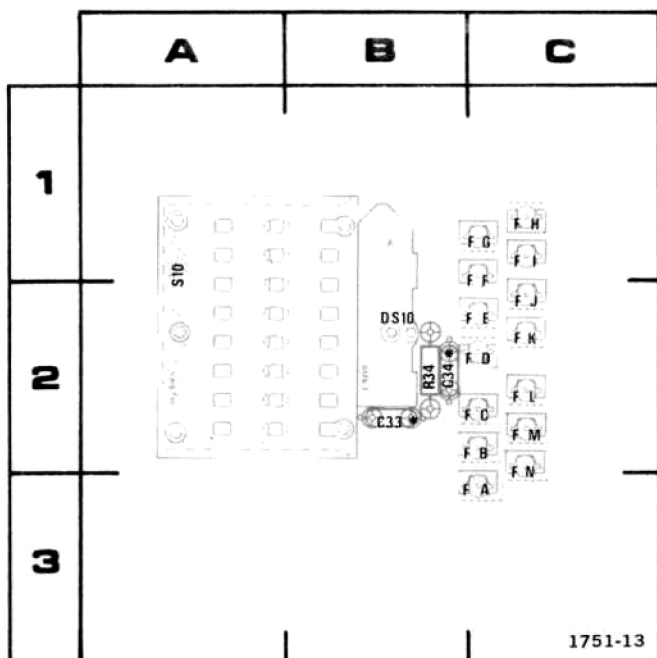

Fig. 8-4. A5—Delayed Triggering Switch Circuit Board.



CKT NO	GRID LOC
C33	2B
C34	2B
DS10	2B
R34	
S10	1A

Fig. 8-5. A2—Source Switch Circuit Board.

*See Parts List for serial number ranges.

CKT NO	GRID LOC
DS100	2B
DS845	2B
P110	2B
P115	2B
P811	2C
P832	2C
S100	2A

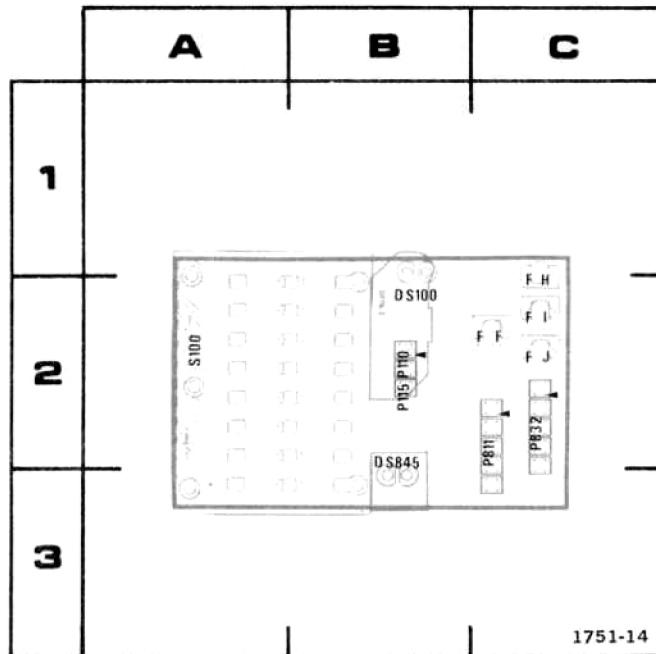
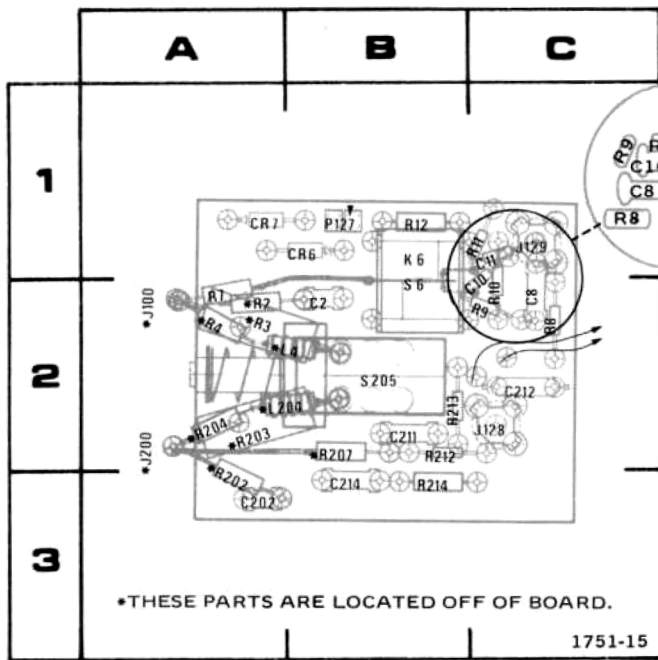
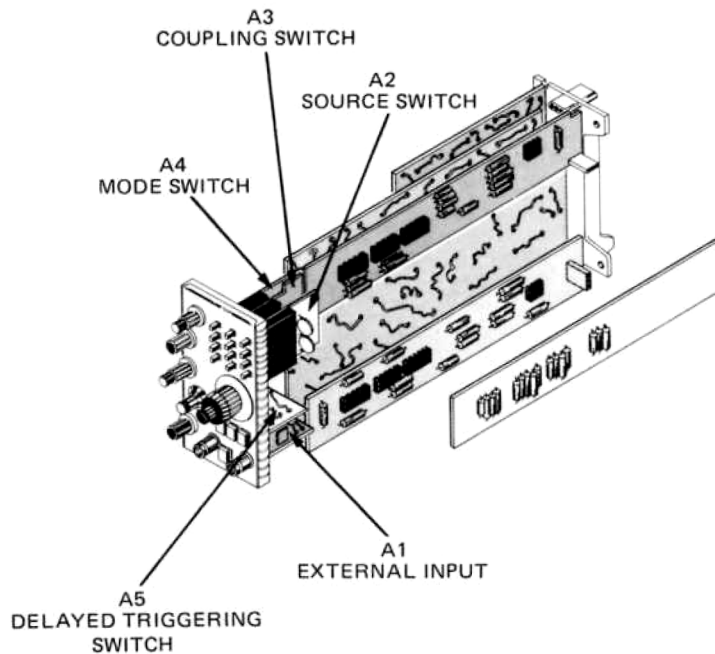

Fig. 8-6. A4—Mode Switch Circuit Board.



CKT NO	GRID LOC	CKT NO	GRID LOC
C2	2B	R2	2A
C10	2C	R3	2A
C11	1C	R4	2A
C202	3A	R7	2A
C211	2B	R8	2C
C212	2C	R9	2C
C214	3B	R10	2C
		R11	1C
CR6	1B	R12	1B
CR7	1A	R202	3A
		R203	2A
J100	2A	R204	2A
J128	2C	R207	2B
J129	1C	R212	2B
J200	2A	R213	2B
		R214	2B
K6	1B	S6	2B
L4	2B	S205	2B
L204	2A		
P127	1B		

Fig. 8-7. A1—External Input Circuit Board.



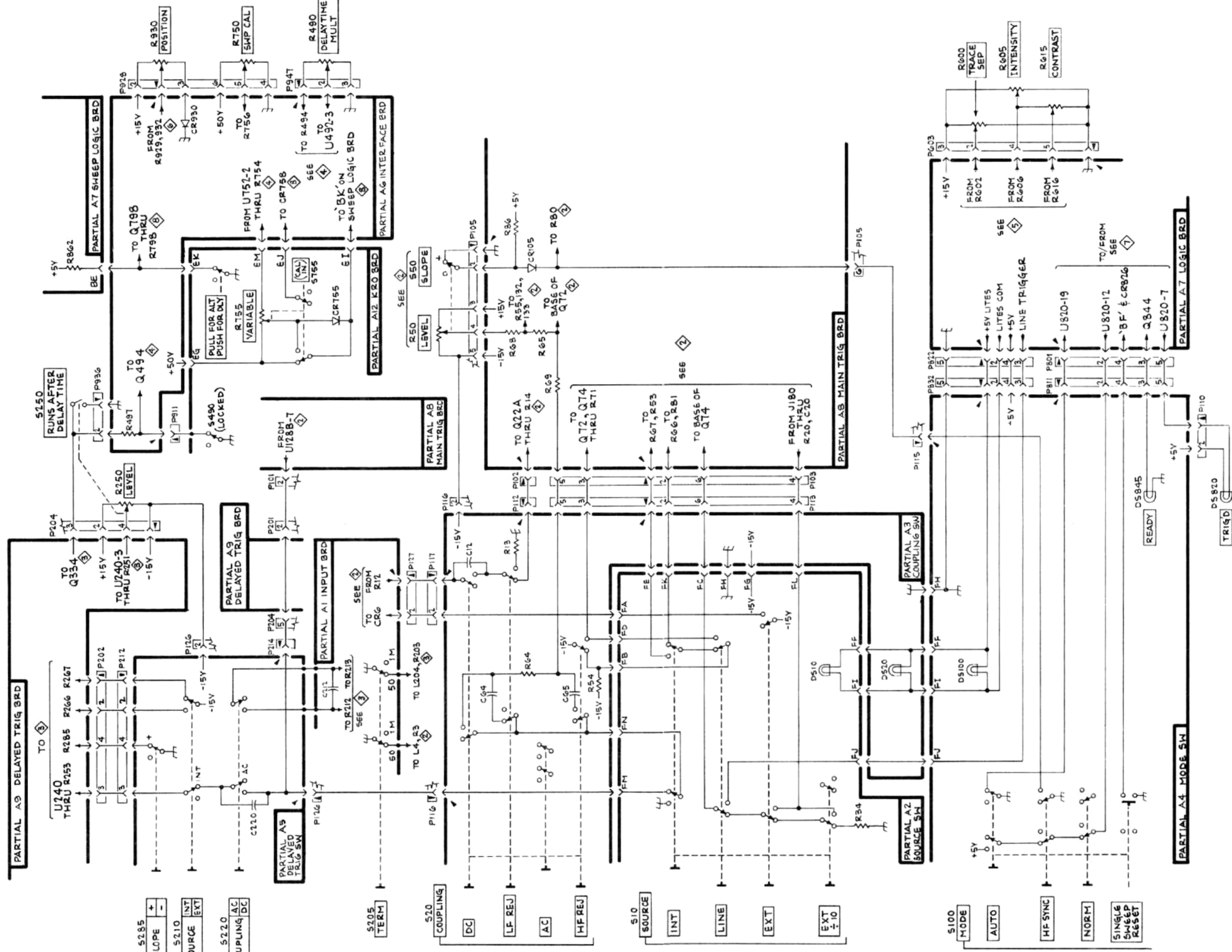

REV JAN 1982
1751-28

FRONT PANEL DISTRIBUTION
(SN B069999 & BELOW)



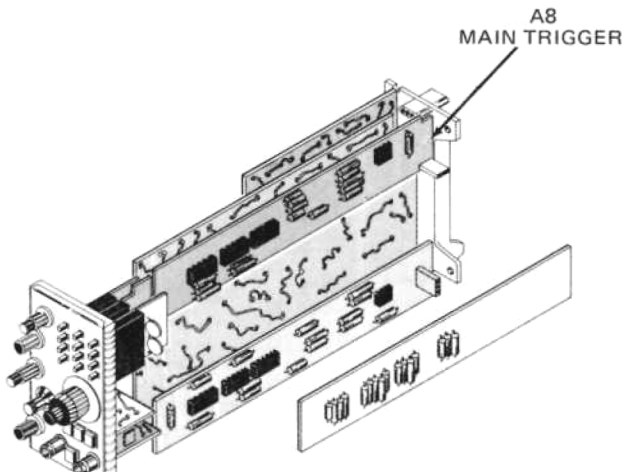
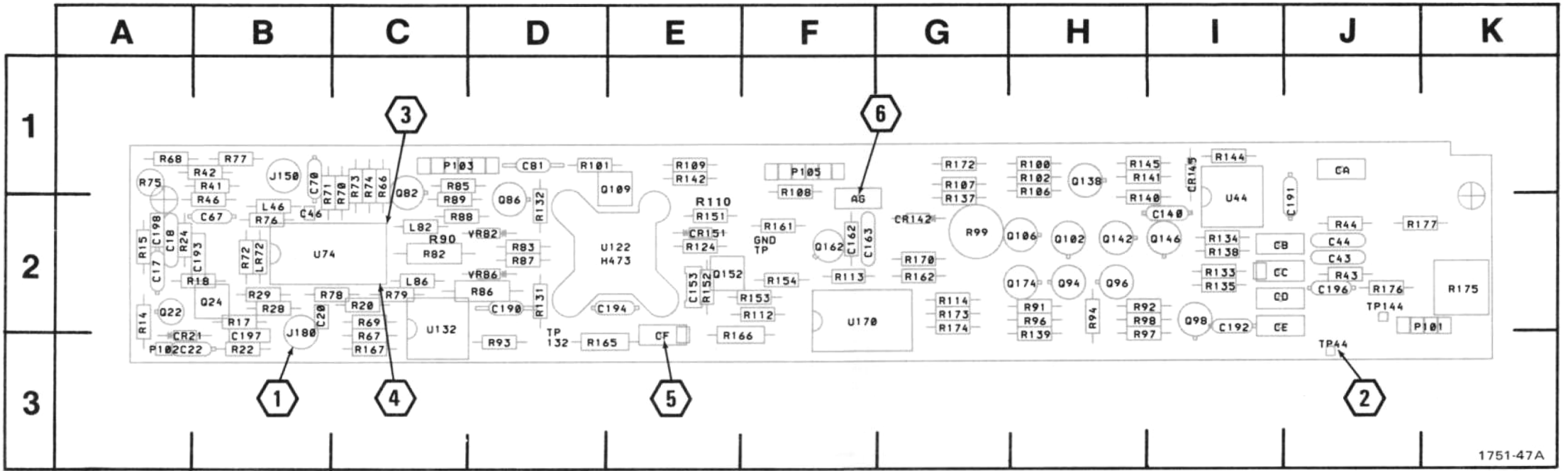
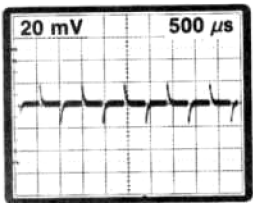

Fig. 8-8. A8—Main Trigger Circuit Board (SN B070000 & up).

REV OCT 1983

CKT NO	GRID LOC	CKT NO	GRID LOC	CKT NO	GRID LOC
C17	2A	R14	2A	R135	2I
C18	2A	R15	2A	R137	2G
C20	2B	R17	2B		
C22	3A	R18	2B	R138	2I
C43	2J	R20	2C	R139	3H
C44	2J	R22	3B	R140	2H
C46	2B	R28	2B	R141	1H
C67	2B	R29	2B	R142	1E
C70	1B	R41	1B	R144	1I
C81	1D	R42	1B	R145	1H
C140	2I	R43	2J	R151	2E
C153	2E	R44	2J	R152	2E
C162	2F	R46	2B	R153	2F
C163	2F	R66	1C	R154	2F
C190	2D	R67	3C	R161	2F
C191	2J	R68	1A	R162	2G
C192	2I	R69	2C	R165	3D
C193	2B	R70	1C	R166	3E
C194	2E	R72	2B	R167	3C
C196	2J	R73	1C	R170	2G
C197	3B	R74	1C	R172	1G
C198	2A	R75	1A	R173	2G
		R76	2B	R174	2G
CR21	3A	R77	1B	R175	2K
CR142	2G	R78	2C	R176	2J
CR145	1I	R79	2C	R177	2J
CR151	2E	R82	2C		
		R83	2D		
J150	1B	R85	1C		
J180	3B	R86	2D		
		R87	2D		
L46	2B	R88	2C	TP44	3J
L82	2C	R89	2C	TP144	2J
L86	2C	R90*	2C	TPGND	2F
		R91	2H	TP132	3D
LR72	2B	R92	2H		
		R93	3D		
P101	2J	R94	2H	U44	2I
P102	3A	R96	2H	U74	2B
P103	1C	R97	3H	U122	2E
P105	1F	R98	2H	U132	2C
		R99	2G	U170	2F
Q22	2A	R100	1H		
Q24	2B	R101	1D	VR82	2D
Q82	1C	R102	1H	VR86	2D
Q86	2D	R106	1H		
Q94	2H	R107	1G		
Q96	2H	R108	1F		
Q98	2I	R109	1E		
Q102	2H	R110*	2E		
Q106	2H	R112	2F		
Q109	1E	R113	2F		
Q138	1H	R114	2G		
Q142	2H	R124	2E		
Q146	2I	R131	2D		
Q152	2E	R132	2D		
Q162	2F	R133	2I		
Q174	2H	R134	2I		

*See Parts List for serial number ranges.



1

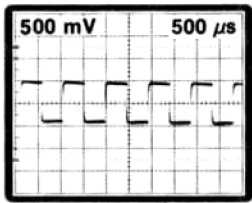

2

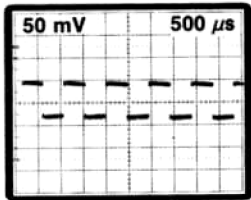

3

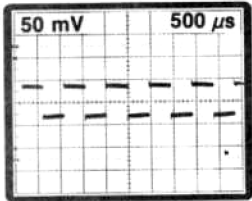

4

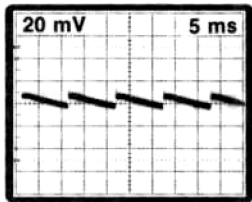

5

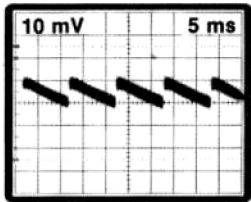

6

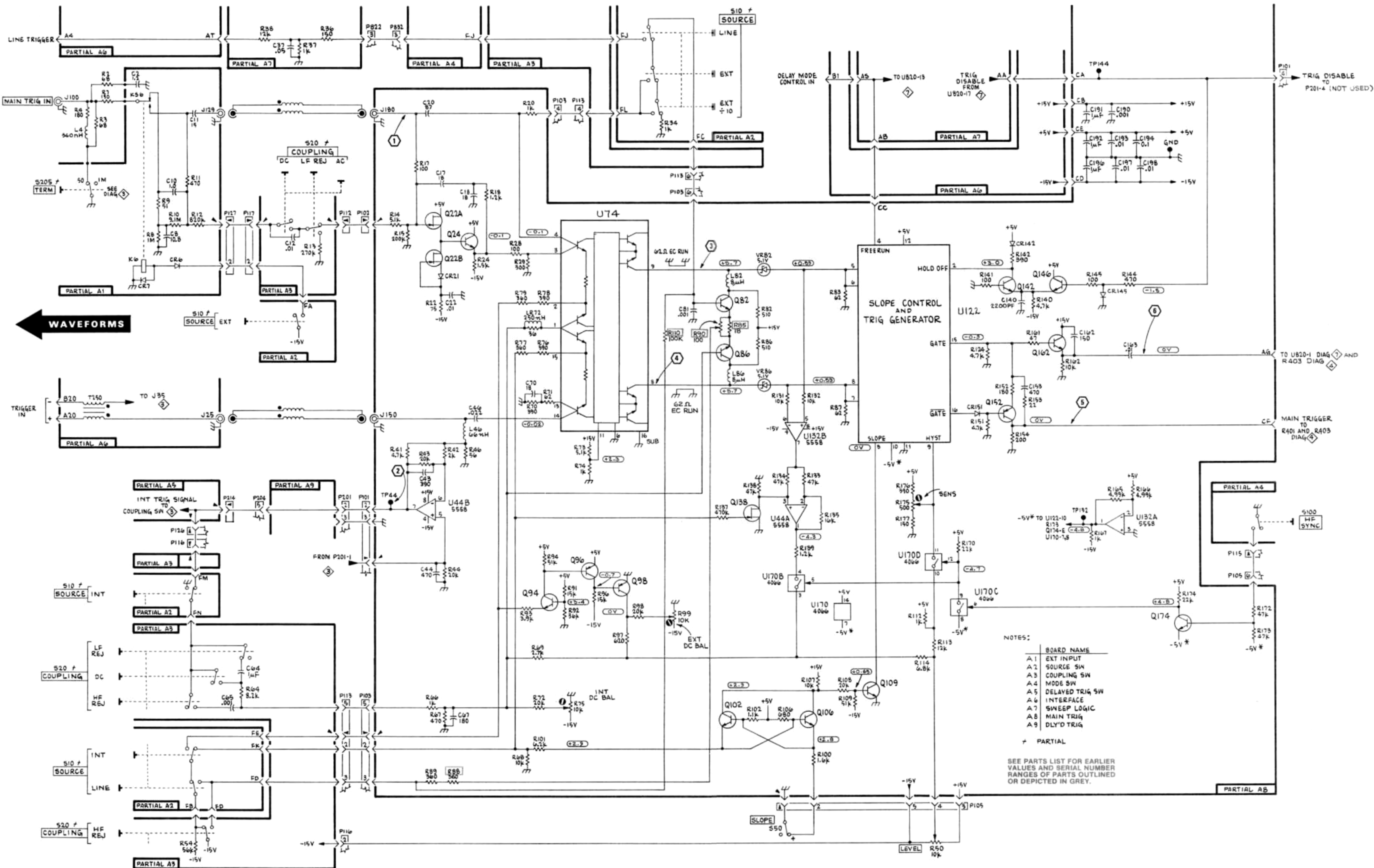

← WAVEFORMS

NOTES:

BOARD NAME
A1 EXT INPUT
A2 SOURCE SW
A3 COUPLING SW
A4 MODE SW
A5 DELAYED TRIG SW
A6 INTERFACE
A7 SWEEP LOGIC
A8 MAIN TRIG
A9 DLY'D TRIG

* PARTIAL

SEE PARTS LIST FOR EARLIER VALUES AND SERIAL NUMBER RANGES OF PARTS OUTLINED OR DEPICTED IN GREY.

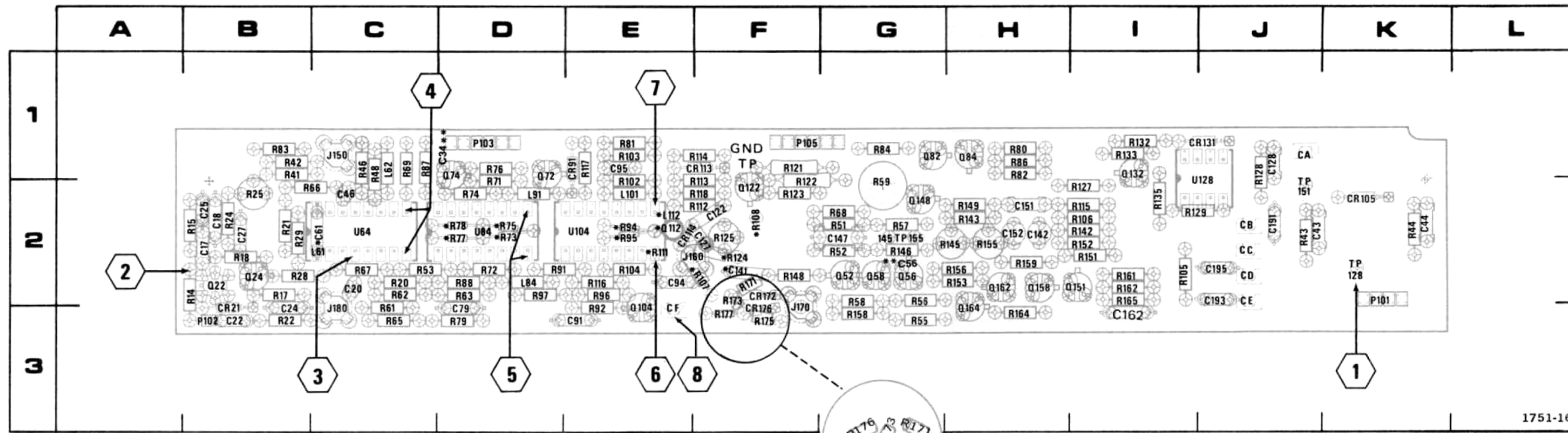
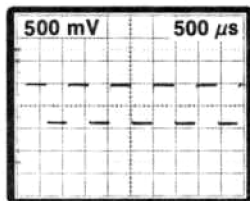
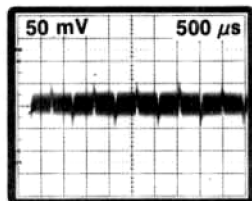

Fig. 8-9. A8—Main Trigger Circuit Board (SN B069999 & below).

CKT NO	GRID LOC	CKT NO	GRID LOC	CKT NO	GRID LOC
C17	2B	Q104	3E	R94	2E
C18	2B	Q112	2E	R95	2E
C20	2C	Q122	2F	R96	2E
C22	3B	Q132	1I	R97	2D
C24	3B	Q148	2G	R102	1E
C25	2B	Q151	2I	R103	1E
C27	2B	Q158	2H	R104	2E
C43	2J	Q162	2H	R105	2I
C44	2K	Q164	3H	R106	2I
C46	2C			R107	2F
C56	G2	R14	2B	R108	2F
C61	2C	R15	2B	R111	2E
C79	3D	R17	2B	R112	2F
C91	3E	R18	2B	R113	1F
C94	2E	R20	2C	R114	1F
C95	1E	R21	2B	R115	2I
C122	2F	R22	3B	R116	2E
C127	2F	R24	2B	R117	1E
C128	1J	R25	2B	R118	2F
C141	2F	R28	2B	R121	1F
C142	2H	R29	2B	R122	1F
C147	2G	R41	1B	R123	2F
C151	2H	R42	1B	R124	2F
C152	2H	R43	2J	R125	2F
C162	3I	R44	2K	R127	2I
C176	2F	R46	1C	R128	1J
C193	2J	R48	1C	R129	2I
C195	2J	R51	2G	R132	1I
		R52	2G	R133	1I
CR21	3B	R53	2C	R135	2I
CR91	1E	R55	3G	R142	2I
CR105	2K	R56	2G	R143	2H
CR113	1F	R57	2G	R145	2H
CR114	2E	R58	2G	R146	2G
CR131	1J	R59	2G	R148	2F
CR172	2F	R61	3C	R149	2H
CR176	3F	R62	2C	R151	2I
		R63	2D	R152	2I
J150	1C	R65	3C	R153	2H
J160	2F	R66	2C	R155	2H
J170	3F	R67	2C	R156	2H
J180	3C	R68	2G	R158	3G
		R69	1C	R159	2H
L61	2C	R71	1D	R161	2I
L62	1C	R72	2D	R162	2I
L84	2D	R73	2D	R164	3H
L91	2D	R74	2D	R165	2I
L101	2E	R75	2D	R171	2F
L112	2E	R76	1D	R173	2F
		R77	2D	R175	3F
P101	2K	R78	2D	R177	3F
P102	3B	R79	3D		
P103	1D	R80	1H	TP128	2K
P105	1F	R81	1E	TP155	2G
		R82	1H	TP161	2J
Q22	2B	R83	1B	TPGND	1F
Q24	2B	R84	1G		
Q52	2G	R86	1H	U64	2C
Q56	2G	R87	1C	U104	2E
Q58	2G	R88	2D	U128	1J
Q72	1D	R91	2D		
Q74	1D	R92	3E		
Q82	1G	R94	2E		
Q84	1H				



1



2

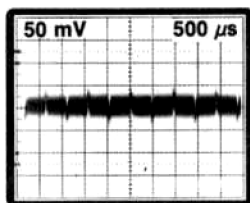

3

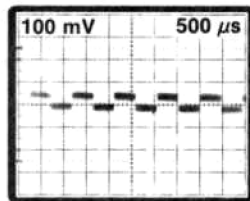

4

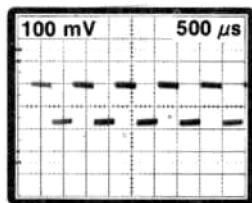

5

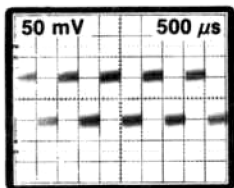

6

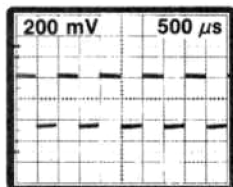

7

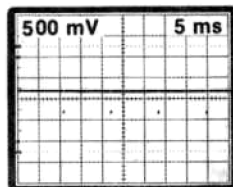

8

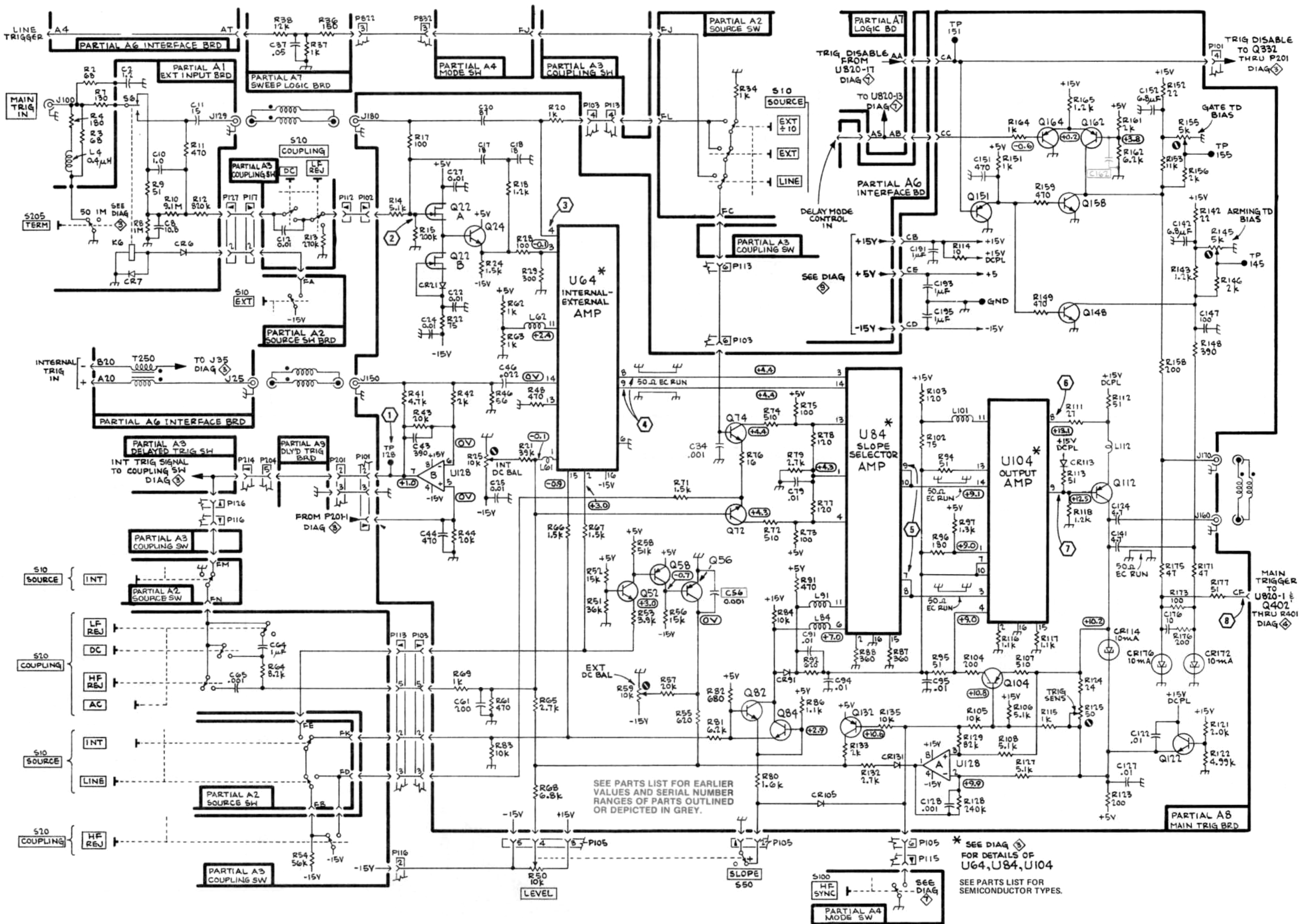

SEE PARTS LIST FOR EARLIER VALUES AND SERIAL NUMBER RANGES OF PARTS OUTLINED OR DEPICTED IN GREY.

* SEE DIAG 3 FOR DETAILS OF U64, U84, U104
SEE PARTS LIST FOR SEMICONDUCTOR TYPES.

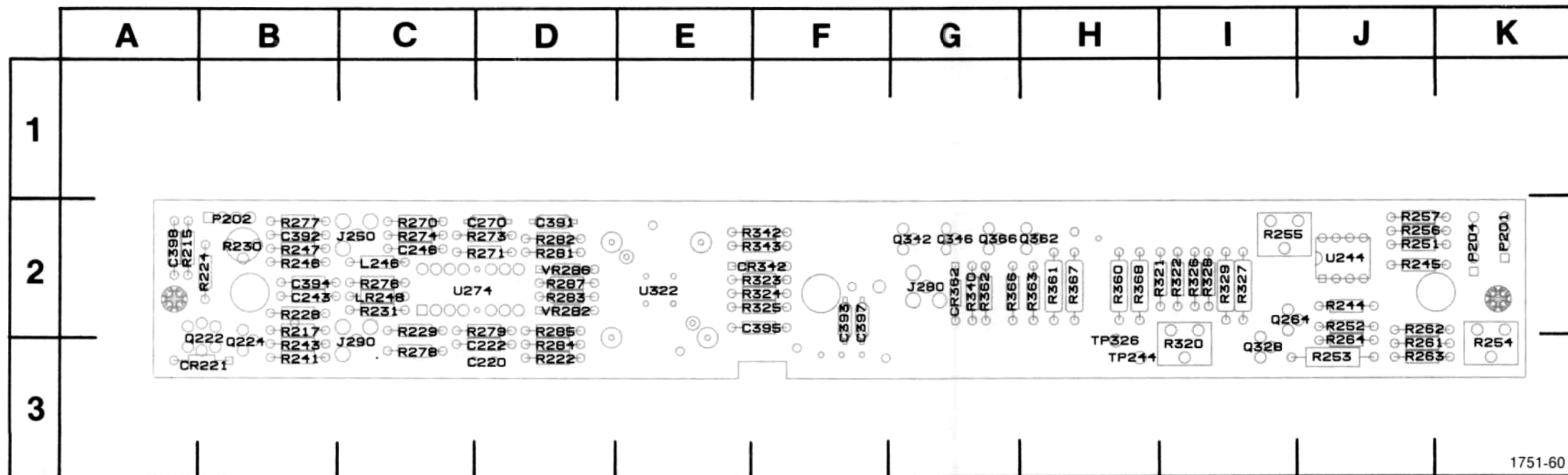
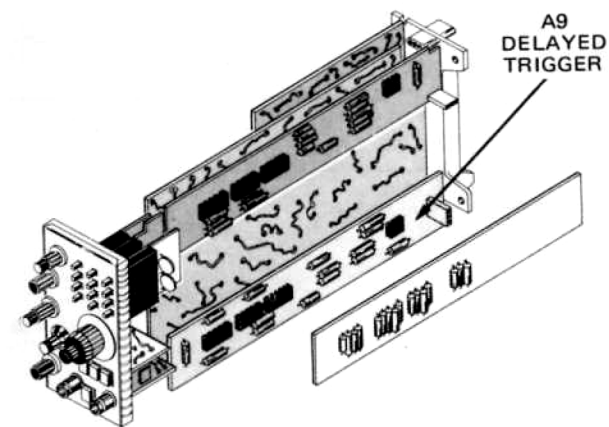
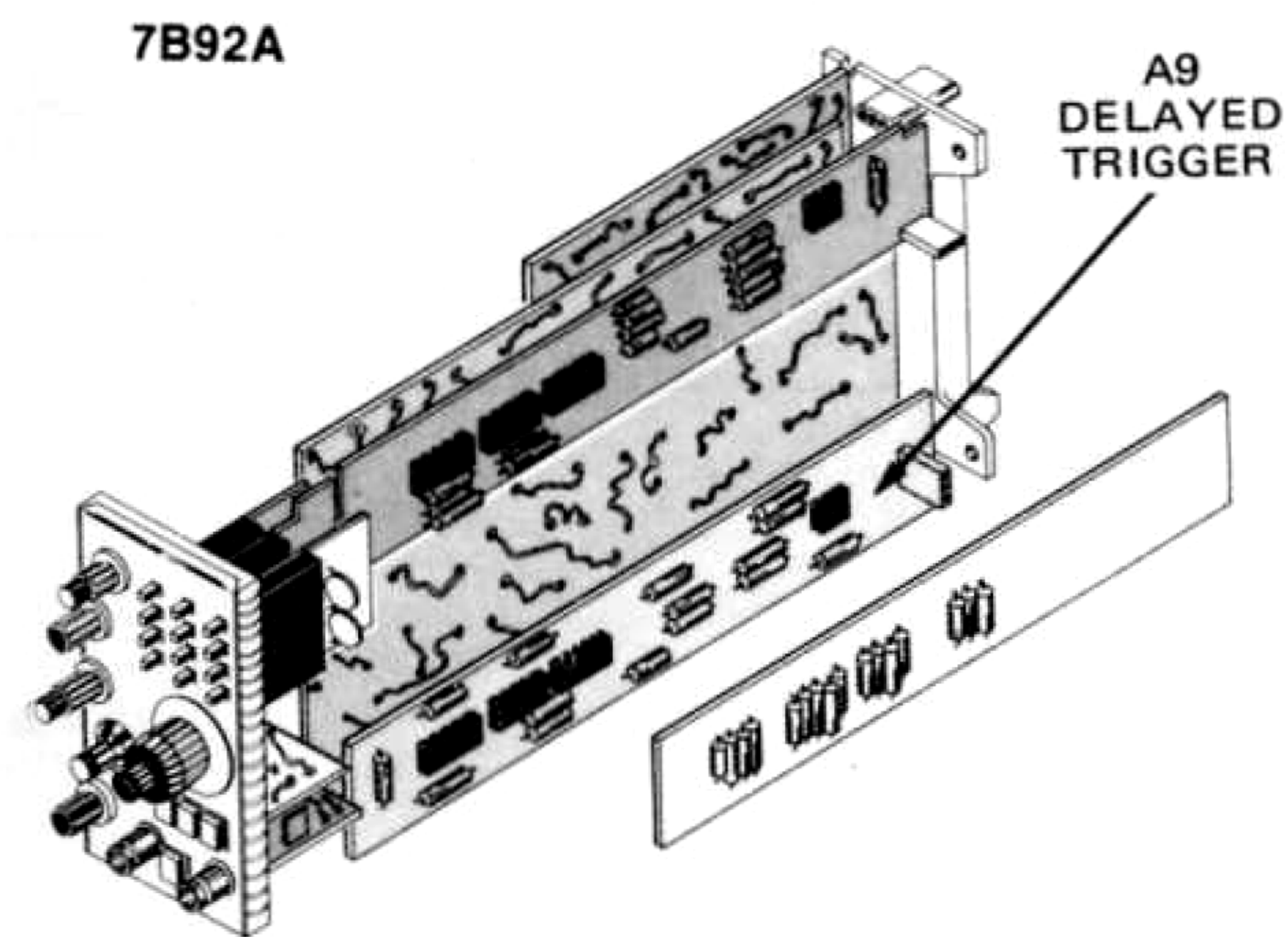

Fig. 8-10. A9-Delayed Trigger Circuit Board (SN B096951 & up).

REV JAN 1985

CKT NO	GRID LOC	CKT NO	GRID LOC	CKT NO	GRID LOC	CKT NO	GRID LOC
C222	3D	Q222	3B	R255	2I	R326	2I
C243	2B	Q224	3B	R256	2J	R327	2I
C246	2C	Q264	2I	R257	2J	R328	2I
C270	2D	Q328	2I	R261	2J	R329	2I
C391	2D	Q342	2G	R262	2J	R340	2G
C392	2B	Q346	2G	R263	2J	R342	2F
C393	2F	Q362	2H	R264	2J	R343	2F
C394	2B	Q366	2G	R270	2C	R360	2H
C395	2F			R271	2D	R361	2H
C397	2F	R215	2A	R273	2D	R362	2G
C398	2A	R217	2B	R274	2C	R363	2H
		R222	3C	R276	2C	R366	2G
CR221	3B	R224	2B	R277	2B	R367	2H
CR342	2F	R228	2B	R278	3C	R368	2H
CR362	2G	R229	2C	R279	2D		
		R230	2B	R281	2D	TP244	3H
J250	2C	R231	2C	R282	2D	TP326	3H
J280	2G	R241	3B	R283	2D		
J290	3C	R243	3B	R284	2D	U244	2J
		R244	2J	R285	2D	U274	2C
L246	2C	R245	2J	R287	2D	U322	2E
LR248	2C	R246	2B	R320	3I		
		R247	2B	R321	2I	VR282	2D
		R251	2J	R322	2I	VR286	2D
P201	2K	R252	2J	R323	2F		
P202	2B	R253	2J	R324	2F		
P204	2K	R254	3K	R325	2F		

A9
DELAYED
TRIGGER



REV JAN 1985

*See Parts List for serial number ranges.

CKT NO	GRID LOC	CKT NO	GRID LOC	CKT NO	GRID LOC	CKT NO	GRID LOC
C221	2C	P202	1A	R253	2J	R324	2E
C222	2C	P204	2K	R254	2K	R325	2E
C224*	2B	Q222	2A	R255	1I	R326	2I
C243	2B	Q224	2A	R256	1J	R327	2I
C246	2B	Q264	2J	R257	1J	R328	2I
C270	1C	Q328	2I	R261	2J	R329	2I
C391	2D	Q342	1E	R262	2J	R340	2E
C392	2A	Q346	2F	R263	2J	R342	1E
C393	2F	Q362	1F	R264	2J	R343	2E
C394	2B	Q366	2F	R270	1C	R360	2G
C395	2D	R215	2A	R271	2C	R361	1G
C397	2F	R217	2B	R273	2C	R362	1F
C398	2A	R222	2C	R274	2C	R363	2F
CR221	2B	R224	2A	R276	2B	R366	2F
CR342	2E	R228	2B	R277	1B	R367	2G
CR362	1F	R229	2C	R278	2C	R368	2G
J250	2C	R230	2A	R279	2C	TP244	2I
J280	2F	R231	2B	R281	2C	TP326	2H
J290	2B	R241	2B	R282	1D	U244	2J
L246	1B	R243	2B	R283	2D	U274	2C
LR248	2B	R244	2J	R284	2C	U322	2D
P201	1J	R245	2J	R285	2C	VR282	2C
		R246	2B	R287	2D	VR286	2C
		R247	1B	R320	2H		
		R251	2J	R321	2G		
				R322	2G		
				R323	2E		

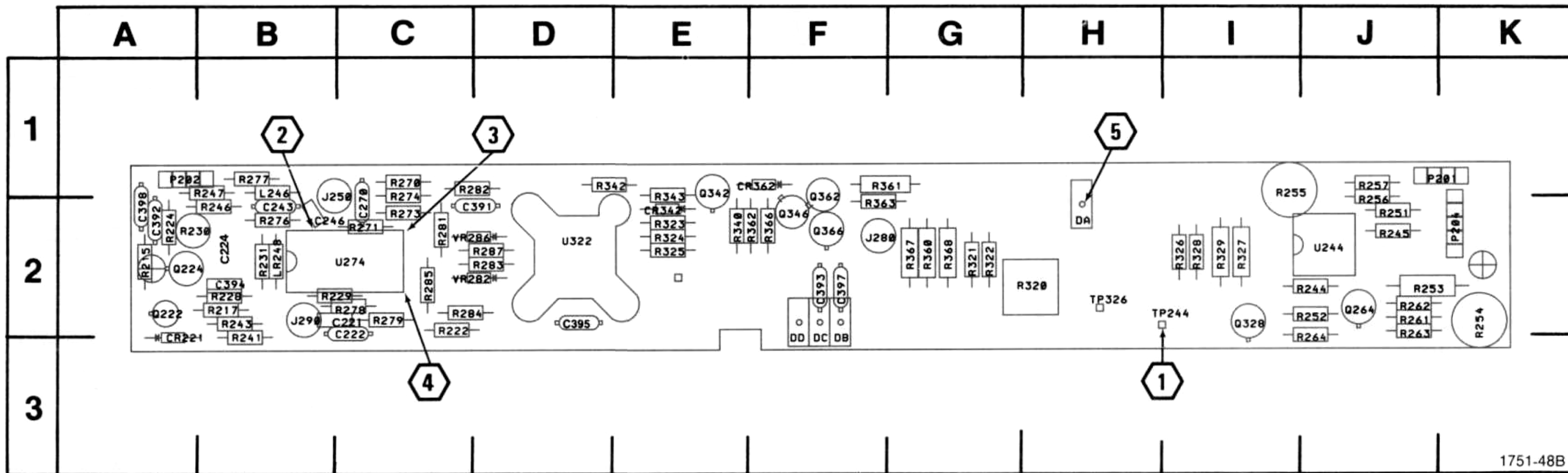

1751-48B

Fig. 8-11. A9-Delayed Trigger Circuit Board (SN B070000 - SN B096950).

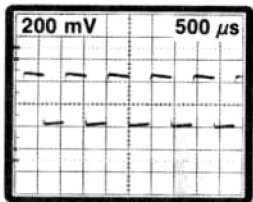

1

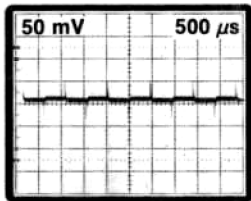

2

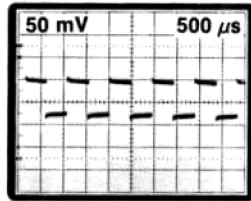

3

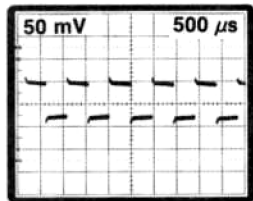

4

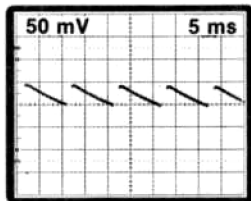

5

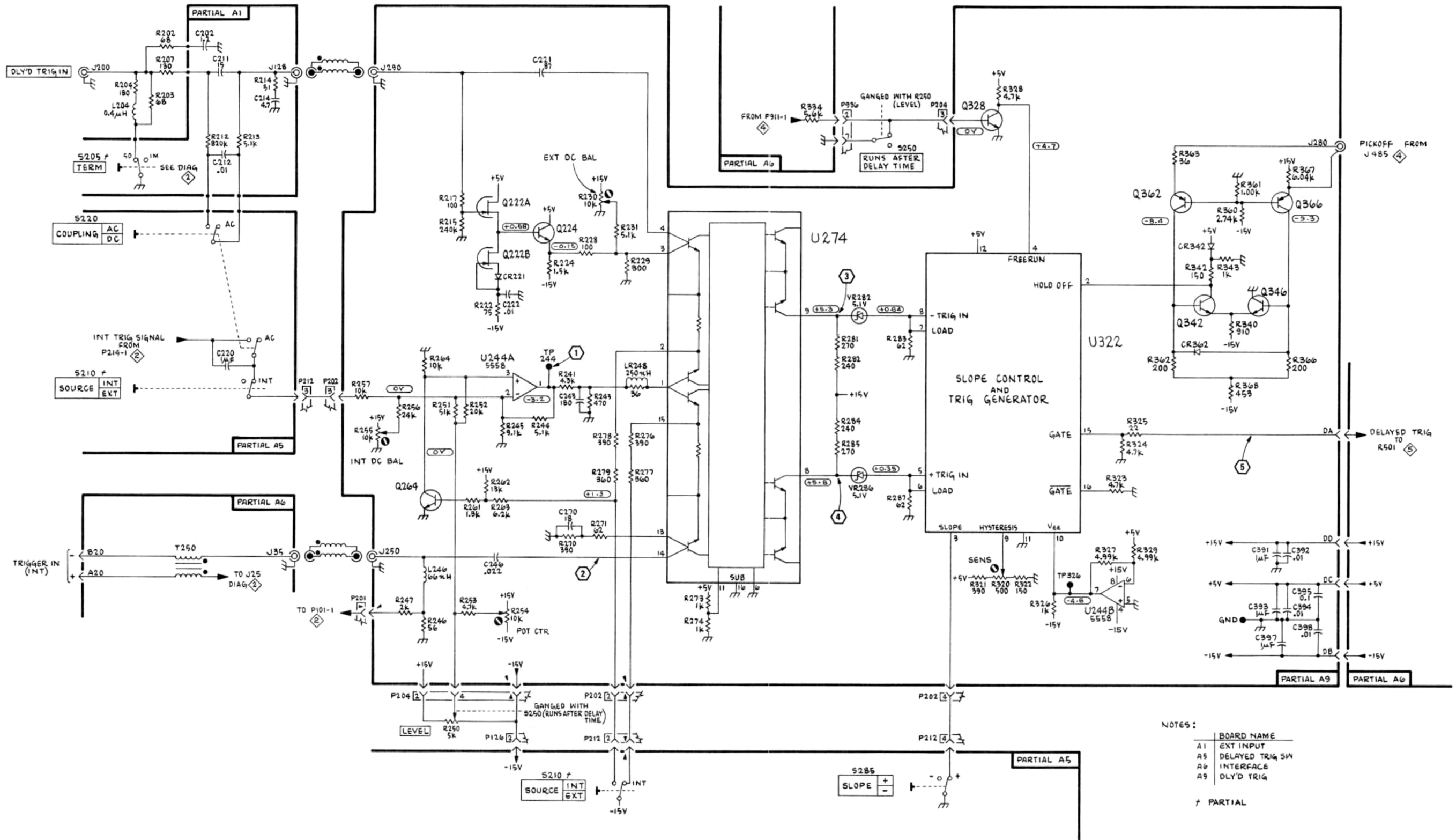

NOTES:

BOARD NAME
A1 EXT INPUT
A5 DELAYED TRIG SW
A6 INTERFACE
A9 DLY'D TRIG

† PARTIAL

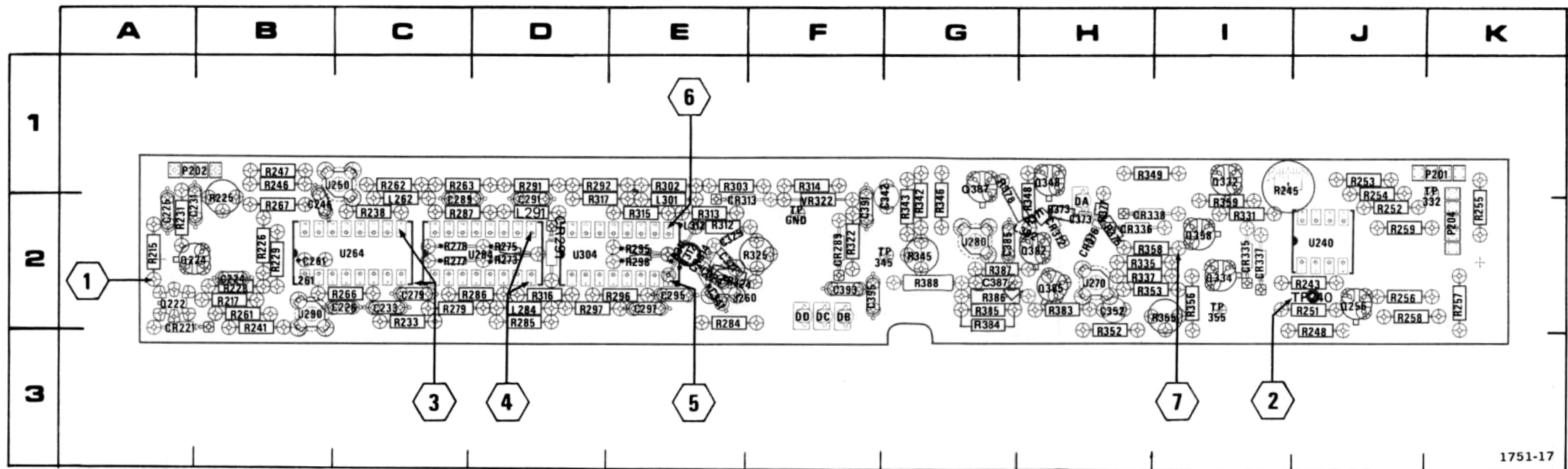

1751-17

*LOCATED ON BACK SIDE OF CIRCUIT BOARD

Fig. 8-12. A9-Delayed Trigger Circuit Board (SN B069999 & below).

CKT NO	GRID LOC	CKT NO	GRID LOC	CKT NO	GRID LOC	CKT NO	GRID LOC
C224	2B	J290	2B	R252	2J	R335	2H
C225	2A			R253	1J	R337	2H
C226	2C	L261	2B	R254	1J	R342	2G
C231	2A	L262	2C	R255	2K	R343	2G
C233	2C	L284	2D	R256	2J	R345	2G
C246	2B	L291	2D	R257	2K	R346	2G
C261	2B	L301	2E	R258	2J	R348	2H
C279	2C	L312	2E	R259	2J	R349	1H
C289	2C	L382**	H2	R261	2B	R352	3H
C291	2D	P201	1K	R262	1C	R353	2H
C295	2E	P202	1A	R263	1C	R355	2I
C297	2E	P204	2K	R266	2C	R356	2I
C321	2E			R267	2B	R358	2H
C324	2E	Q222	2A	R273	2D	R359	2I
C325	2E	Q224	2A	R275	2D	R371	2H
C341	2E	Q256	2J	R277	2C	R373	2H
C342	2G	Q312	2E	R278	2C	R375	2G
C352	2H	Q332	1I	R279	2C	R377	2H
C373	2H	Q334	2I	R284	2E	R378**	1G
C285	2G	Q348	1H	R285	2D	R383	2H
C387**	2G	Q358	2I	R286	2D	R384**	2G
C391	2F	Q387**	1G	R287	2C	R385	2G
C393	2F	Q382	2H	R291	1D	R386	2G
C395	2F	Q385	2H	R295	2E	R387	2G
				R296	2E	R388	2G
CR221	2A	R215	2A	R297	2D		
CR289	2F	R217	2B	R298	2E	TP240	2J
CR291	2D	R225	2B	R302	1E	TP332	1K
CR313	2E	R226	2B	R303	1E	TP345	2G
CR314	2E	R228	2B	R311	2E	TP355	2I
CR335	2I	R229	2B	R312	2E	TPGND	2F
CR336	2H	R231	2A	R313	2E		
CR337	2I	R233	2C	R314	1F	U240	2J
CR338	2H	R238	2C	R315	2E	U264	2C
CR372	2H	R241	2B	R316	2D	U284	2D
CR376	2H	R243	2J	R317	2D	U304	2D
		R245	1I	R322	2F		
J250	1C	R246	1B	R324	2E	VR322	2F
J260	2E	R247	1B	R325	2F		
J270	2H	R248	3J	R331	2I		
J280	2G	R251	2J	R335	2H		

**See Parts List for serial number ranges.

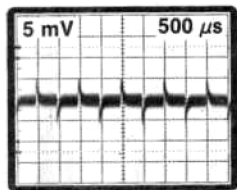

1

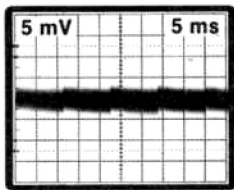

2

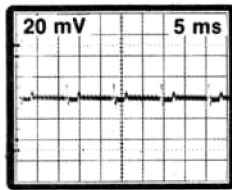

3

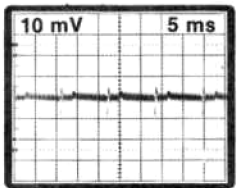

4

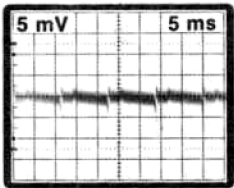

5

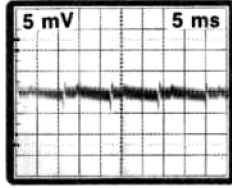

6

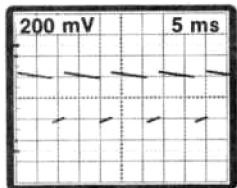

7

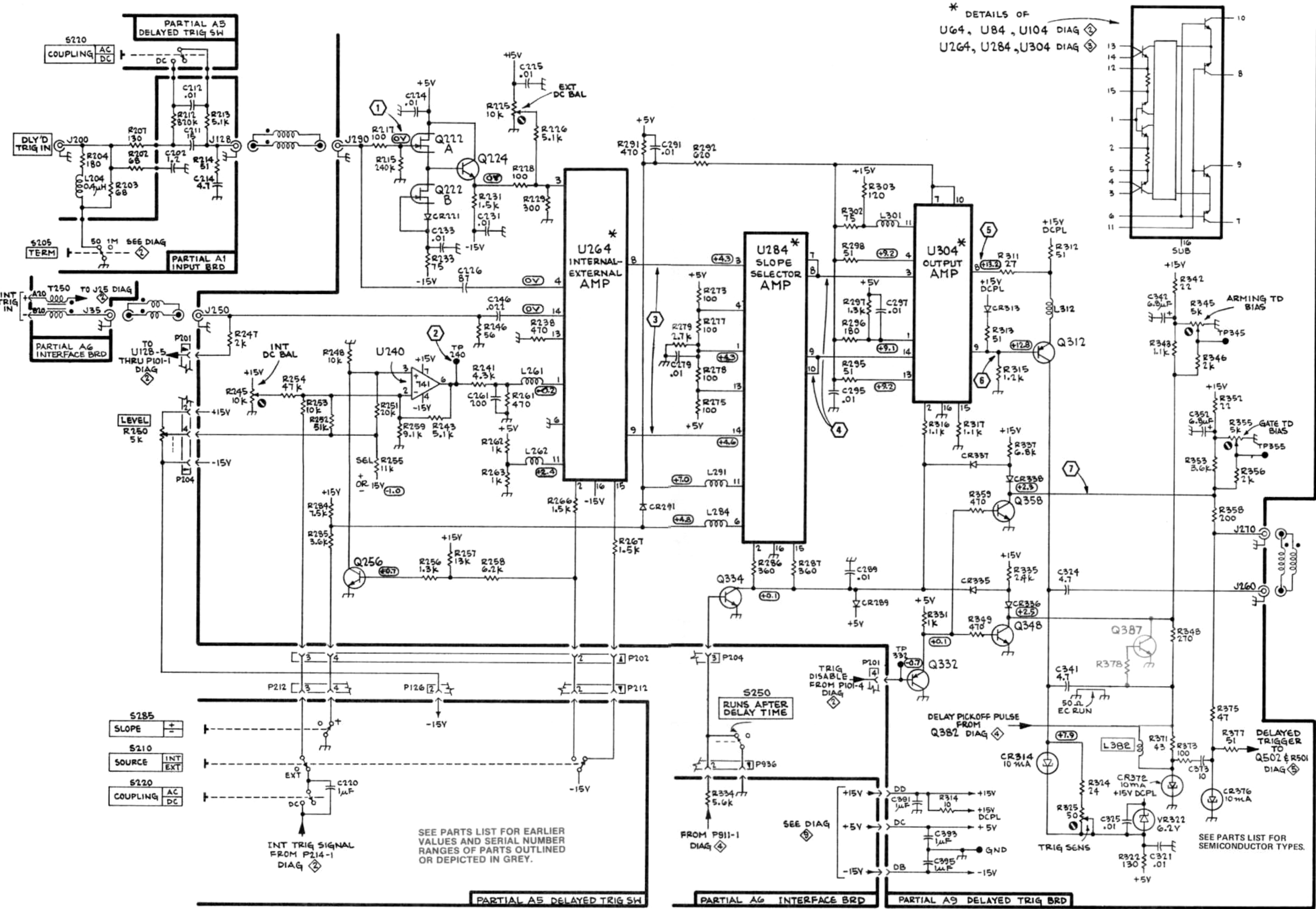

* DETAILS OF
 U64, U84, U104 DIAG ②
 U264, U284, U304 DIAG ③

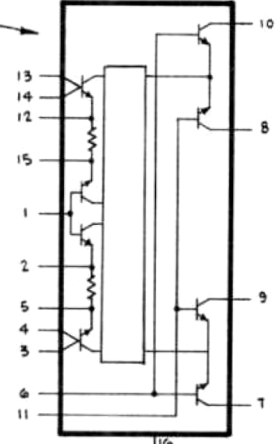

S285	SLOPE	+
S210	SOURCE	INT EXT
S220	COUPLING	AC DC

INT TRIG SIGNAL FROM P214-1 DIAG ②

SEE PARTS LIST FOR EARLIER VALUES AND SERIAL NUMBER RANGES OF PARTS OUTLINED OR DEPICTED IN GREY.

S250 RUNS AFTER DELAY TIME

DELAY PICKOFF PULSE FROM Q382 DIAG ④

SEE PARTS LIST FOR SEMICONDUCTOR TYPES.

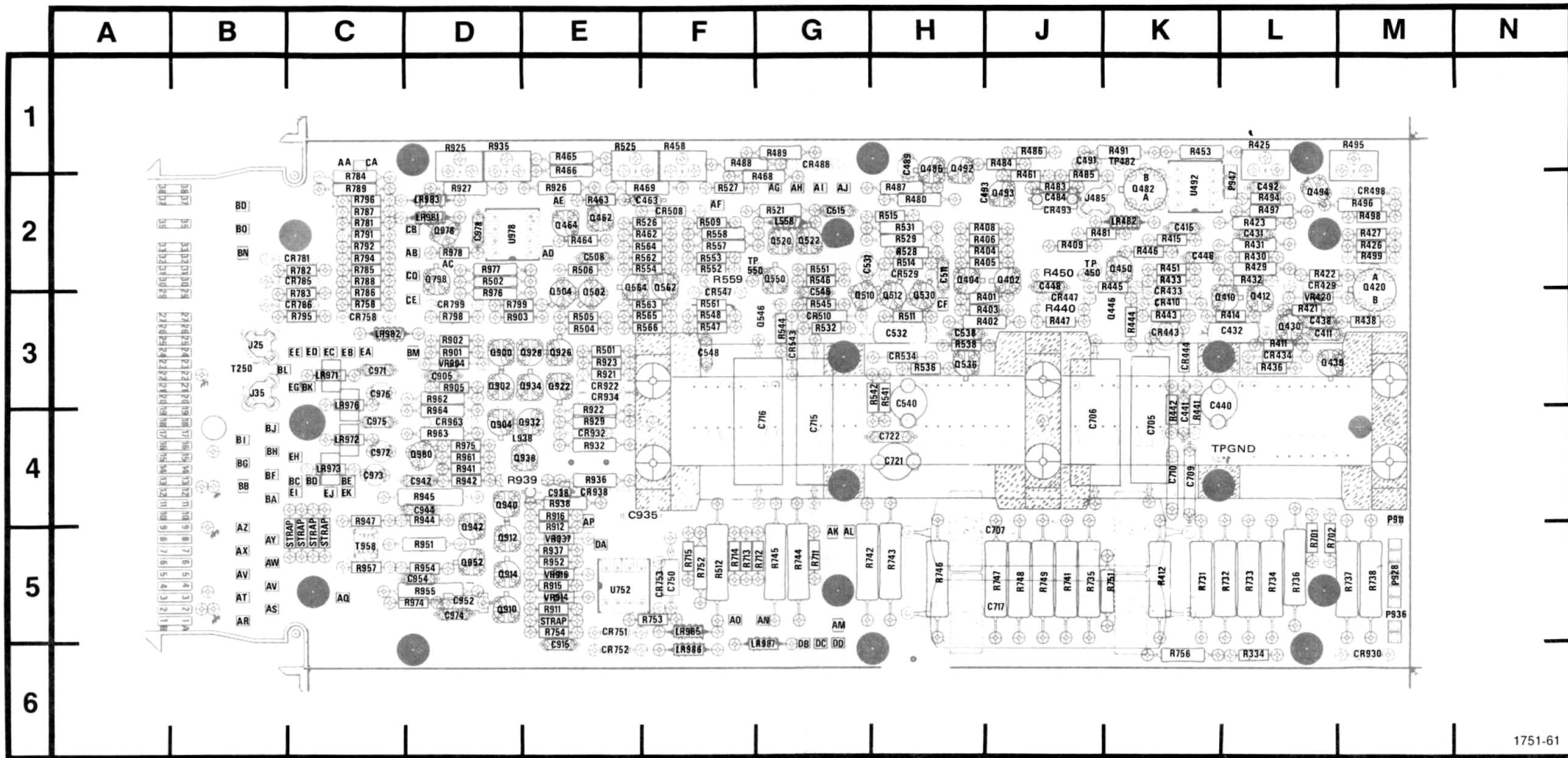

1751-61

Fig. 8-13. A6-Interface Circuit Board (SN B095741 & up).

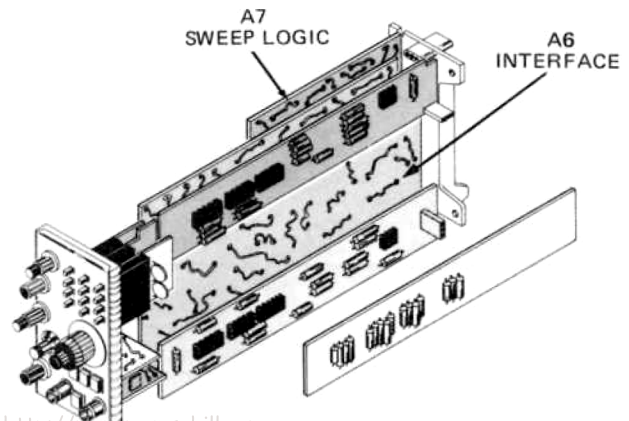

CKT NO	GRID LOC	CKT NO	GRID LOC	CKT NO	GRID LOC	CKT NO	GRID LOC	CKT NO	GRID LOC
C411	3L	CR786	3C	Q934	3E	R504	3E	R784	2C
C415	2K	CR799	3D	Q938	4E	R505	3E	R785	2C
C431	2L	CR922	3E	Q940	4D	R506	2E	R786	2C
C432	3L	CR930	6M	Q942	5D	R509	2F	R787	2C
C438	3L	CR932	4E	Q952	5D	R511	3H	R788	2C
C440	4K	CR934	3E	Q960	4D	R512	5F	R789	2C
C441	4K	CR938	4E	Q978	2D	R514	2H	R791	2C
C446	2K	CR963	4D			R515	2H	R792	2C
C448	2J			R334	6L	R521	2G	R794	2C
C463	2F	J25	3B	R401	3J	R525	1E	R795	3C
C484	2J	J35	3B	R402	3J	R526	2F	R796	2C
C489	1H	J485	2J	R403	3J	R527	2F	R798	3D
C491	1J			R404	2H	R528	2H	R799	3D
C492	2L	L558	2G	R405	2H	R529	2H	R901	3D
C493	2H	L938	4D	R406	2H	R531	2H	R902	3D
C508	2E			R408	2H	R532	3G	R903	3D
C511	2H	LR482	2K	R409	2J	R536	3H	R905	3D
C515	2G	LR971	3C	R411	3L	R538	3H	R911	5E
C531	2G	LR972	4C	R412	5K	R541	3H	R912	5E
C532	3H	LR973	4C	R414	3L	R542	3G	R915	5E
C538	3H	LR976	3C	R415	2K	R544	3G	R916	4E
C540	3H	LR981	2D	R421	3L	R545	3G	R921	3E
C546	3G	LR982	3C	R422	2L	R546	2G	R922	4E
C548	3F	LR983	2D	R423	2L	R547	3F	R923	3E
C705	4K	LR985	5F	R425	1L	R548	3F	R925	1D
C706	4J	LR986	6F	R426	2M	R551	2G	R926	2E
C707	5J	LR987	6G	R427	2M	R552	2F	R927	2D
C709	4J			R429	2L	R553	2F	R929	4E
C710	4J	P911	5M	R430	2L	R554	2F	R932	4E
C715	4G	P928	5M	R431	2L	R557	2F	R935	1D
C716	4G	P936	5M	R432	2L	R558	2F	R936	4E
C717	5J	P947	2L	R433	2K	R559	2F	R937	5E
C721	4H			R436	3L	R561	3F	R938	4E
C722	4H	Q402	2J	R438	3M	R562	2F	R939	4D
C750	5F	Q404	2H	R440	3J	R563	3F	R941	4D
C905	3D	Q410	3L	R441	4K	R564	2F	R942	4D
C915	6E	Q412	3L	R442	4K	R565	3F	R944	4D
C935	4E	Q420	2M	R443	3K	R566	3F	R945	4D
C938	4E	Q430	3L	R444	3K	R701	5L	R947	4C
C942	4D	Q436	3L	R445	2K	R702	5L	R951	5D
C944	4D	Q446	3K	R446	2K	R711	5G	R952	5E
C952	5D	Q450	2K	R447	3J	R712	5F	R954	5D
C954	5D	Q462	2E	R450	2J	R713	5F	R955	5D
C971	3C	Q464	2E	R451	2K	R714	5F	R957	5C
C972	4C	Q482	1H	R453	1K	R715	5F	R961	4D
C974	5D	Q486	1H	R458	1F	R731	5K	R962	3D
C975	4C	Q492	1H	R461	2J	R732	5L	R963	4D
C976	3C	Q493	2J	R462	2F	R733	5L	R964	3D
C978	2D	Q494	2L	R463	2E	R734	5L	R974	5D
		Q502	2E	R464	2E	R735	5J	R975	4D
CR410	3K	Q504	2E	R465	1E	R736	5L	R977	2D
CR429	2L	Q510	3G	R466	1E			R978	2D
CR433	3K	Q512	3H	R468	2G	R737	5M		
CR434	3L	Q520	2G	R469	2F	R738	5M	T250	3B
CR443	3K	Q522	2G	R480	2H	R741	5J	T958	5C
CR444	3K	Q530	3H	R481	2J	R742	5G		
CR447	3J	Q536	3H	R483	2J	R743	5H	TP450	2J
CR488	1G	Q546	3G	R484	1J	R744	5G	TP482	1K
CR493	2J	Q550	2G	R485	2J	R745	5G	TP550	2F
CR498	2M	Q562	2F	R486	1J	R746	5H	TPGND	4L
CR508	2F	Q564	2E	R487	2H	R747	5J		
CR510	3G	Q798	2D	R488	1F	R748	5J	U492	2K
CR529	2H	Q900	3D	R489	1G	R749	5J	U752	5E
CR534	3H	Q902	3D	R491	1K	R751	5K	U978	2D
CR543	3G	Q904	4D	R494	2L	R752	5F		
CR547	3F	Q910	5D	R495	1M	R753	5F	VR420	3L
CR751	5E	Q912	5D	R496	2M	R754	5E	VR904	3D
CR752	6E	Q914	5D	R497	2L	R756	6K	VR914	5E
CR753	5F	Q922	3E	R498	2M	R758	3C	VR916	5E
CR758	3C	Q926	3E	R499	2M	R781	2C	VR937	5E
CR781	2C	Q928	3E	R501	3E	R782	2C		
CR785	2C	Q932	4E	R502	2D	R783	2C		

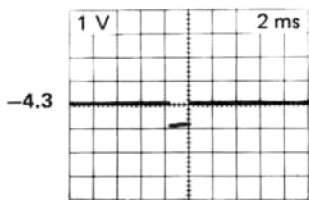

1

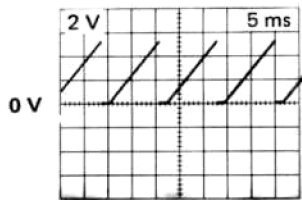

2

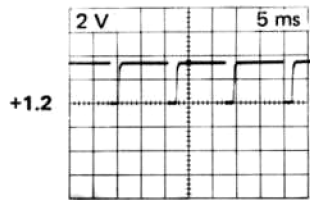

3

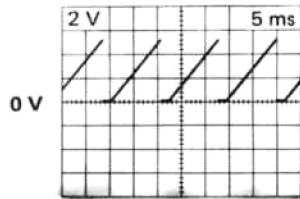

4

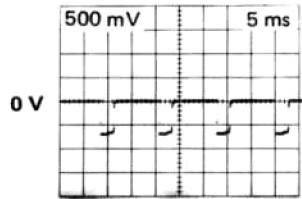

5

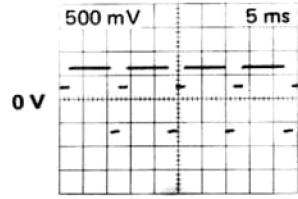

6

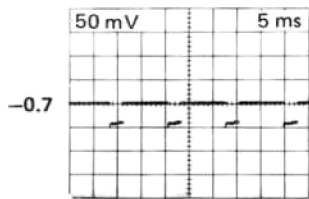

7

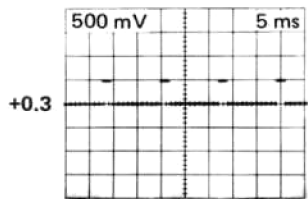

8

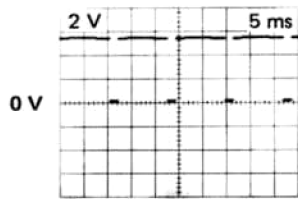

9, 10

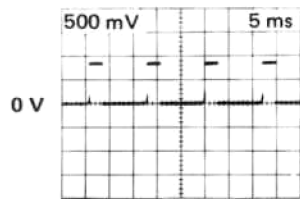

11

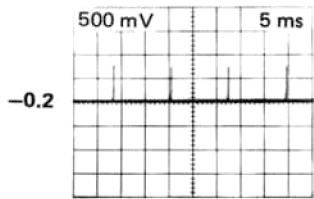

12

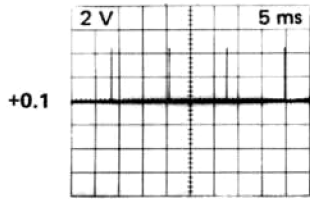

13

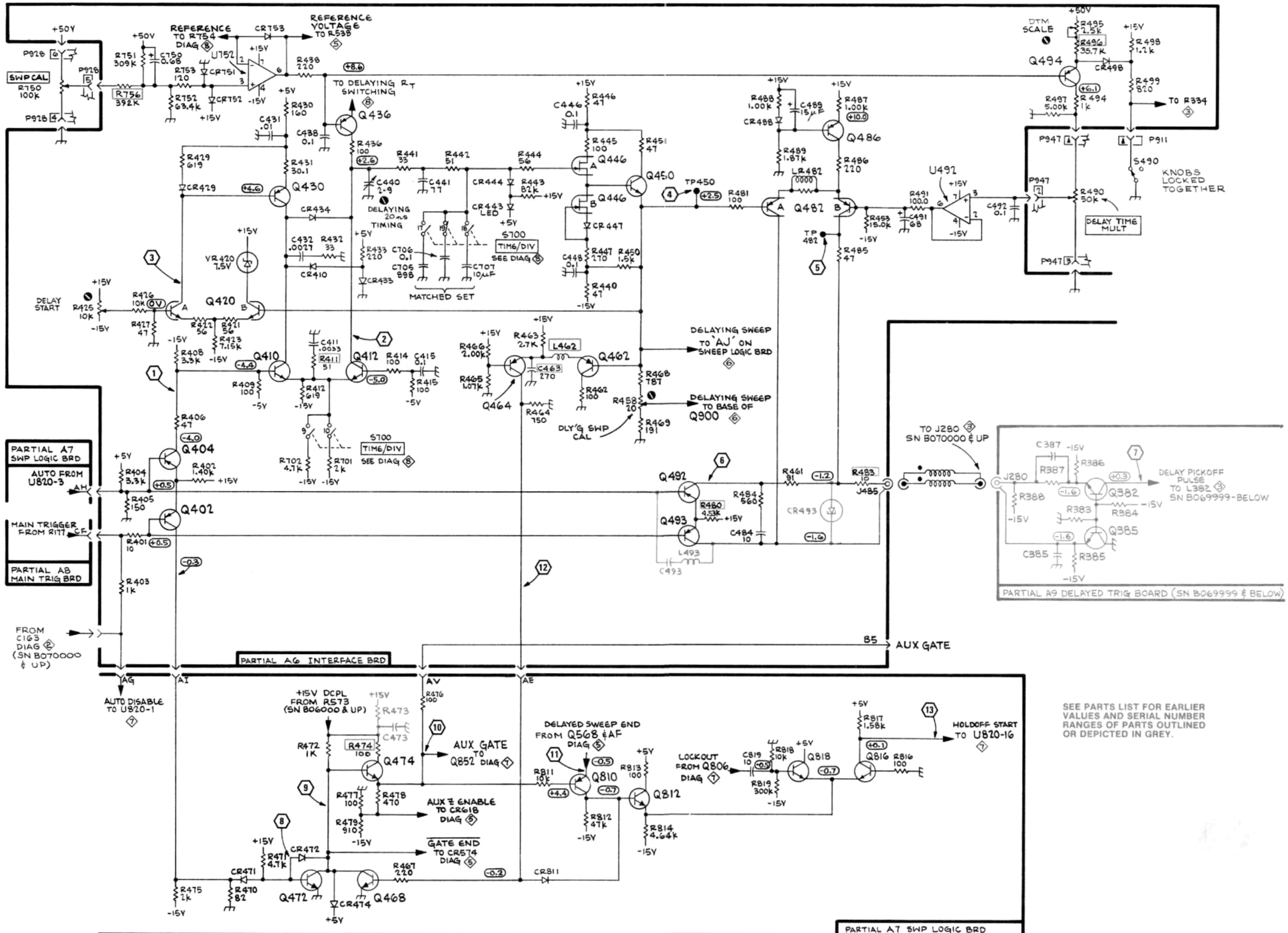

CKT NO	GRID LOC	CKT NO	GRID LOC	CKT NO	GRID LOC	CKT NO	GRID LOC	CKT NO	GRID LOC	CKT NO	GRID LOC
C411	3K	CR753	5E	Q564	2E	R483	2I	R737	5K	R964	4D
C415	2J	CR758	3C	Q798	2C	R484	1H	R738	5K	R974	5C
C431	2J	CR781	2B	Q900	3D	R485	1I	R741	5I	R975	4D
C432	3J	CR785	2B	Q902	3D	R486	1H	R742	5G	R977	2D
C438	3K	CR786	3B	Q904	4D	R487	2G	R743	5G	R978	2D
C440	3J	CR488	1G	Q910	5D	R488	1F	R744	5F		
C441	4J	CR799	3D	Q912	5D	R489	1F	R745	5F	T250	3B
C446	2J	CR922	3E	Q914	5D	R491	1I	R746	5H	T958	5C
C448	2I	CR930	6K	Q922	3D	R494	2K	R747	5H		
C463*	2E	CR932	4E	Q926	3D	R495	1K	R748	5H	TP450	2I
C484	2I	CR934	3E	Q928	3D	R496	2K	R749	5I	TP482	1I
C489	1G	CR938	4E	Q932	4D	R497	2K	R751	5I	TP550	2F
C491	1I	CR963	4D	Q934	3D	R498	2K	R752	5F	TPGND	4J
C492	2K			Q938	4D	R499	2K	R753	5E		
C493	2H	J25	3B	Q940	4D	R501	3E	R754	5D	U492	2J
C508	2E	J35	3B	Q942	5D	R502	2C	R756	6J	U752	5E
C511	2H	J485	2I	Q952	5D	R504	3E	R758	3C	U978	2D
C515	2G			Q960	4C	R505	3E	R781	2C		
C531	2G	L462*	2D	Q978	2D	R506	2E	R782	2B	VR420	3K
C532	3G	L493*	2H			R509	2F	R783	3B	VR904	3D
C538	3H	L558	2F	R334	6J	R511	3G	R784	1C	VR914	5D
C540	3G	L938	4D	R401	3H	R512	5F	R785	2C	VR916	5D
C546	3G			R402	3H	R514	2G	R786	3C	VR937	5D
C548	3F	LR482	2I	R403	3H	R515	2G	R787	2C		
C705	4J	LR971	3B	R404	2H	R521	2F	R788	2C		
C706	4I	LR972	4C	R405	2H	R525	1E	R789	2C		
C707	5H	LR973	4C	R406	2H	R526	2E	R791	2C		
C709	4J	LR976	4C	R408	2H	R527	2F	R792	2C		
C710	4J	LR981	2C	R409	2I	R528	2G	R794	2C		
C715	4F	LR982	3C	R411	3K	R529	2G	R795	3B		
C716	4F	LR983	2C	R412	5J	R531	2G	R796	2C		
C717	5H	LR985	5F	R414	3J	R532	3G	R798	3D		
C721	4G	LR986	6F	R415	2J	R536	3H	R799	3D		
C722	4G	LR987	6F	R421	3K	R538	3H	R901	3D		
C750	5E			R422	2K	R541	3G	R902	3D		
C905	3D	P911	4L	R423	2J	R542	3G	R903	3D		
C915	6D	P928	5L	R425	1J	R544	3F	R905	3D		
C935	4E	P936	5L	R426	2K	R545	3G	R911	5D		
C938	4D	P947	2J	R429	2J	R546	2G	R912	4D		
C942	4C			R430	2J	R547	3F	R915	5D		
C944	4C	Q402	2H	R431	2J	R548	3F	R916	4D		
C952	5D	Q404	2H	R432	2J	R551	2G	R921	3E		
C954	5C	Q410	3J	R433	2J	R552	2F	R922	4E		
C971	3C	Q412	3J	R436	3K	R553	2F	R923	3E		
C972	4C	Q420	2K	R438	3K	R554	2E	R925	1D		
C974	5D	Q430	3K	R440	2I	R557	2F	R926	2D		
C975	4C	Q436	3K	R441	4J	R558	2F	R927	2D		
C976	3C	Q446	3I	R442	4J	R559	2F	R929	4E		
C978	2D	Q450	2I	R443	3J	R561	2E	R932	4E		
		Q462	2E	R444	3I	R562	2E	R935	1D		
CR410	3J	Q464	2E	R445	3I	R563	3E	R936	4E		
CR429	2K	Q482	2I	R446	2I	R564	2E	R937	5D		
CR433	3J	Q486	1H	R447	3I	R565	3E	R938	4D		
CR434	3K	Q492	1H	R450	2I	R566	3E	R939	4D		
CR443	3J	Q493	2H	R451	2J	R701	5K	R941	4D		
CR444	3J	Q494	2K	R453	1J	R702	5K	R942	4D		
CR447	3I	Q502	2E	R458	1E	R711	5G	R944	4C		
CR493	2I	Q504	2E	R461	1H	R712	5F	R945	4C		
CR498	2K	Q510	3G	R462	2E	R713	5F	R947	4C		
CR508	2E	Q512	3G	R463	2E	R714	5F	R951	5C		
CR510	3G	Q520	2F	R464	2E	R715	5F	R952	5D		
CR529	2G	Q522	2G	R465	1E	R731	5J	R954	5C		
CR534	3G	Q530	3H	R466	1E	R732	5J	R955	5C		
CR543	3F	Q536	3H	R468	2F	R733	5J	R957	5C		
CR547	3F	Q546	3F	R469	2E	R734	5J	R961	4D		
CR751	5E	Q550	2F	R480	2H	R735	5I	R962	3C		
CR752	6E	Q562	2E	R481	2I	R736	5K	R963	4D		

*See Parts List for
serial number ranges.

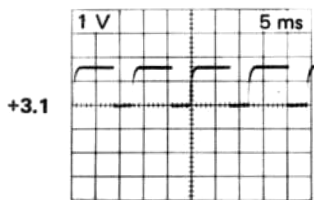

1

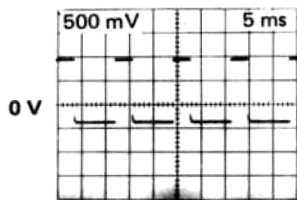

2

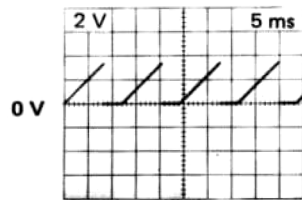

3

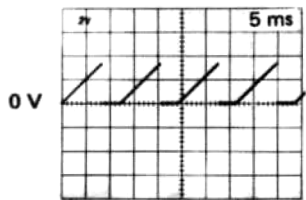

4

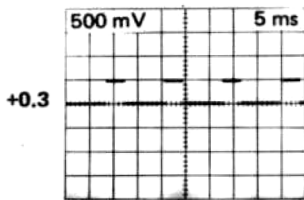

5

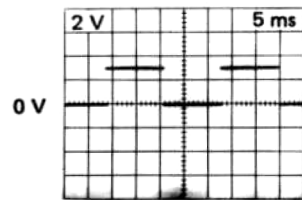

6

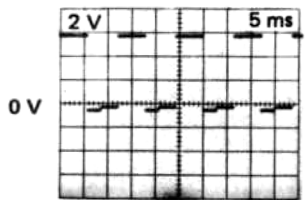

7

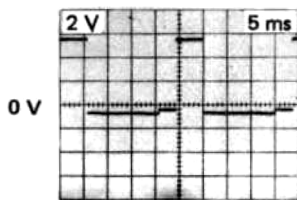

8

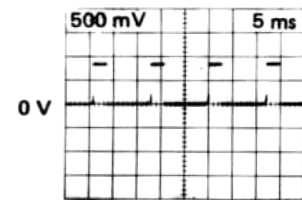

9

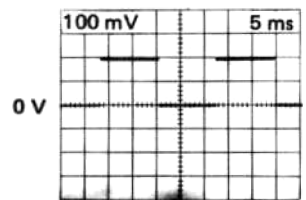

10

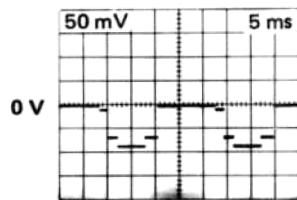

11

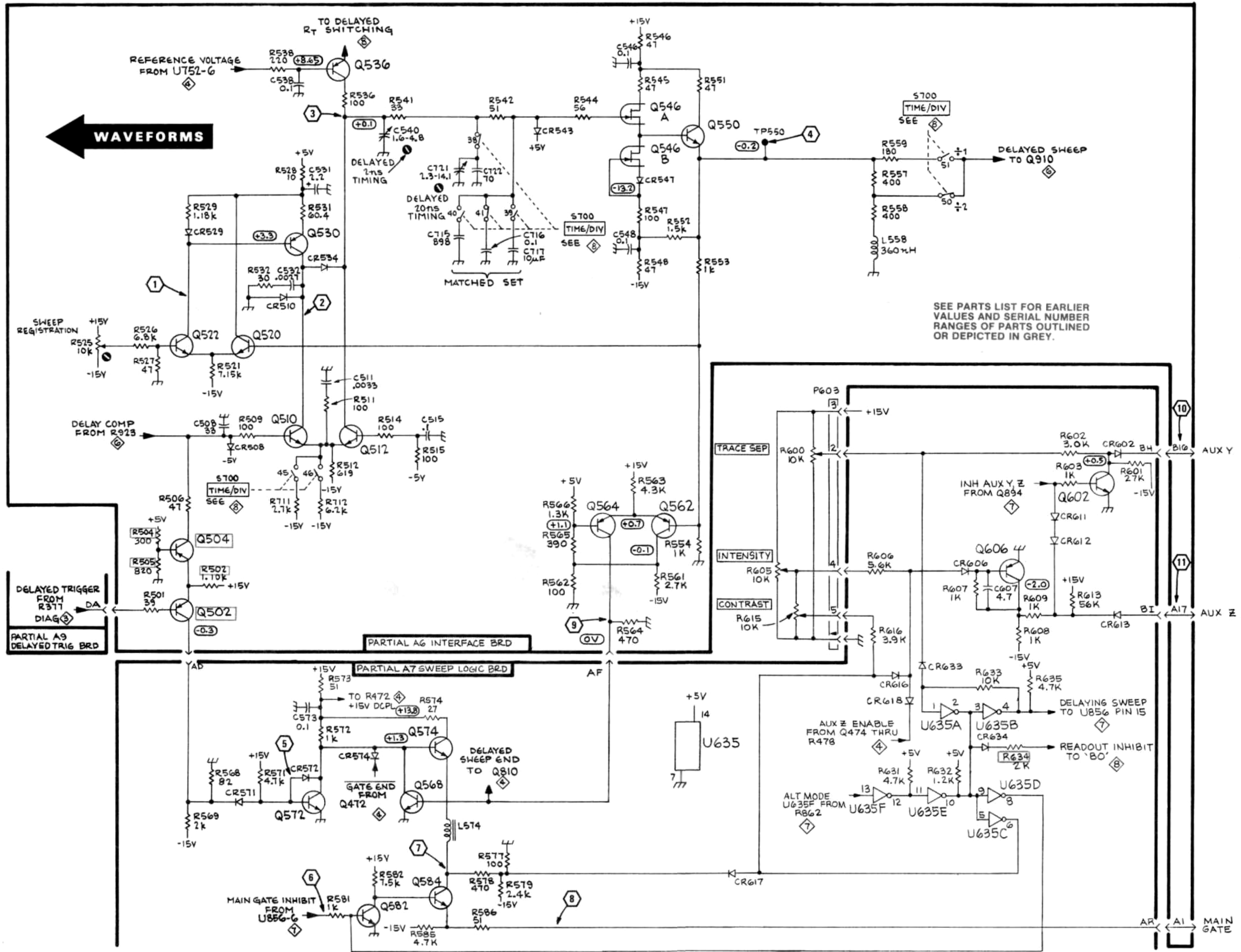

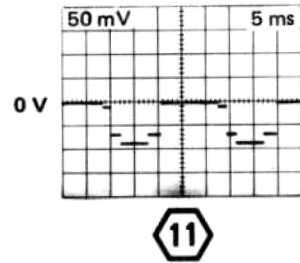
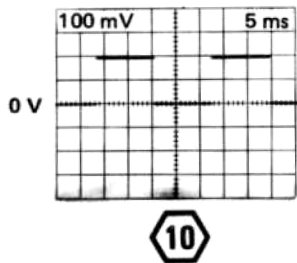
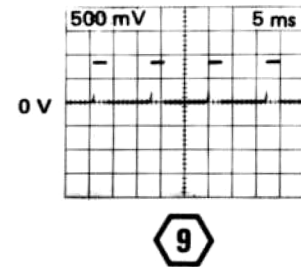
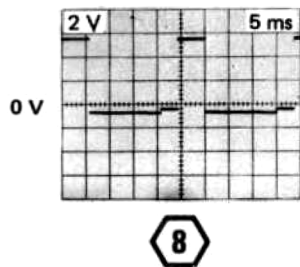
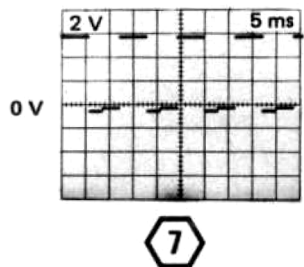
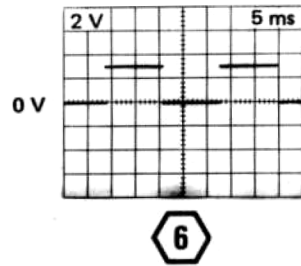
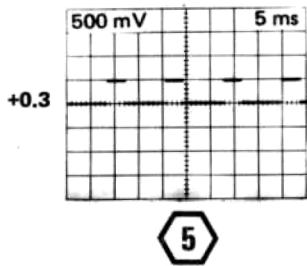
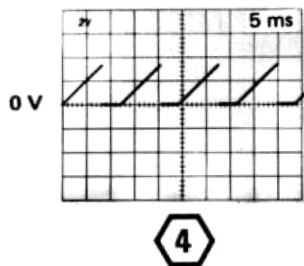
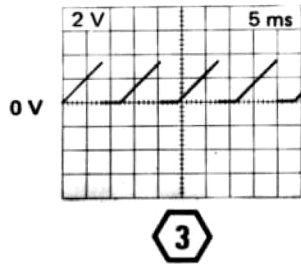
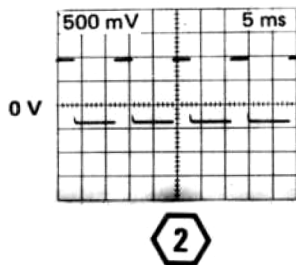
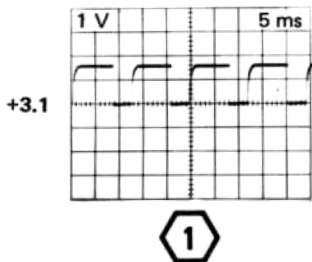

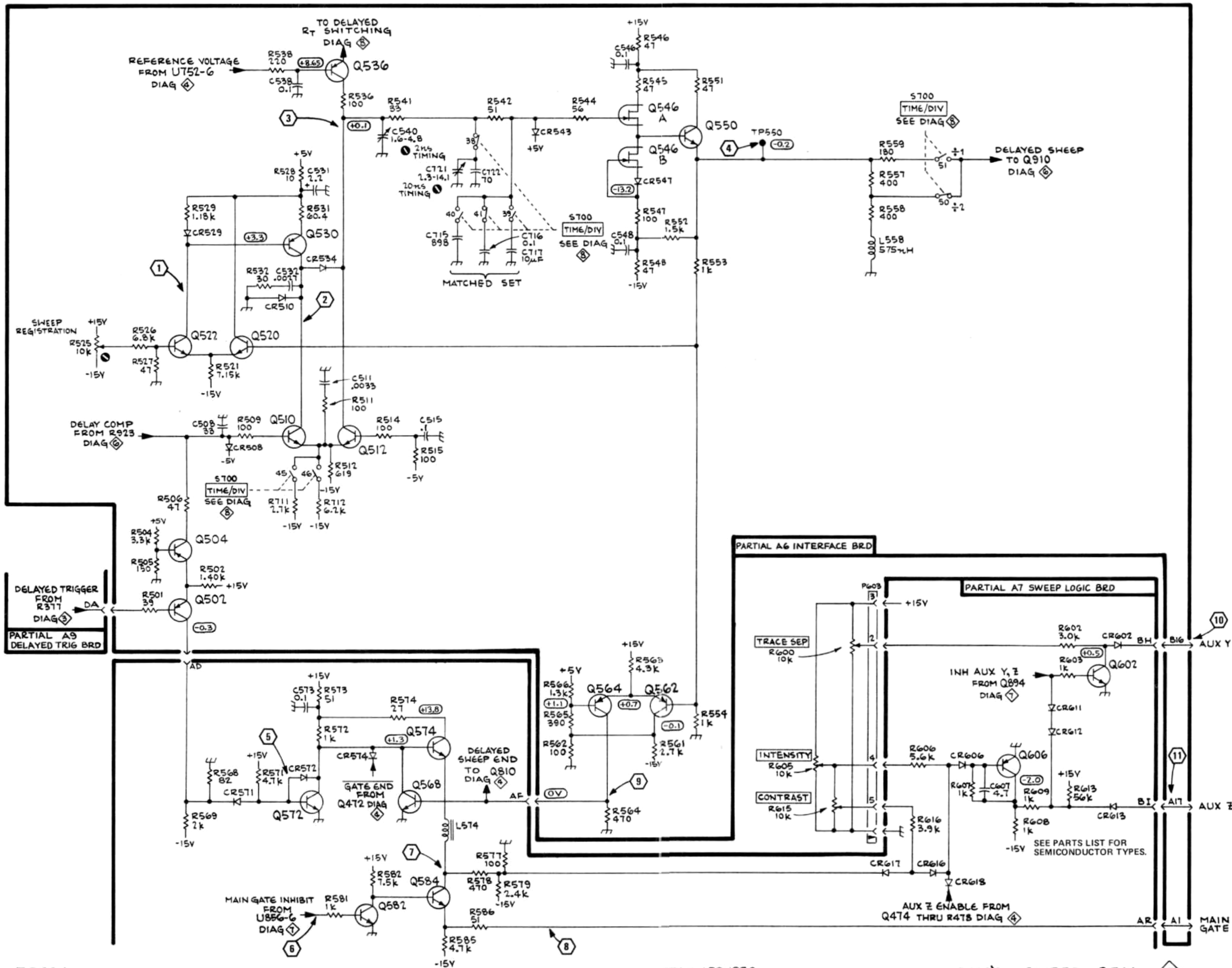

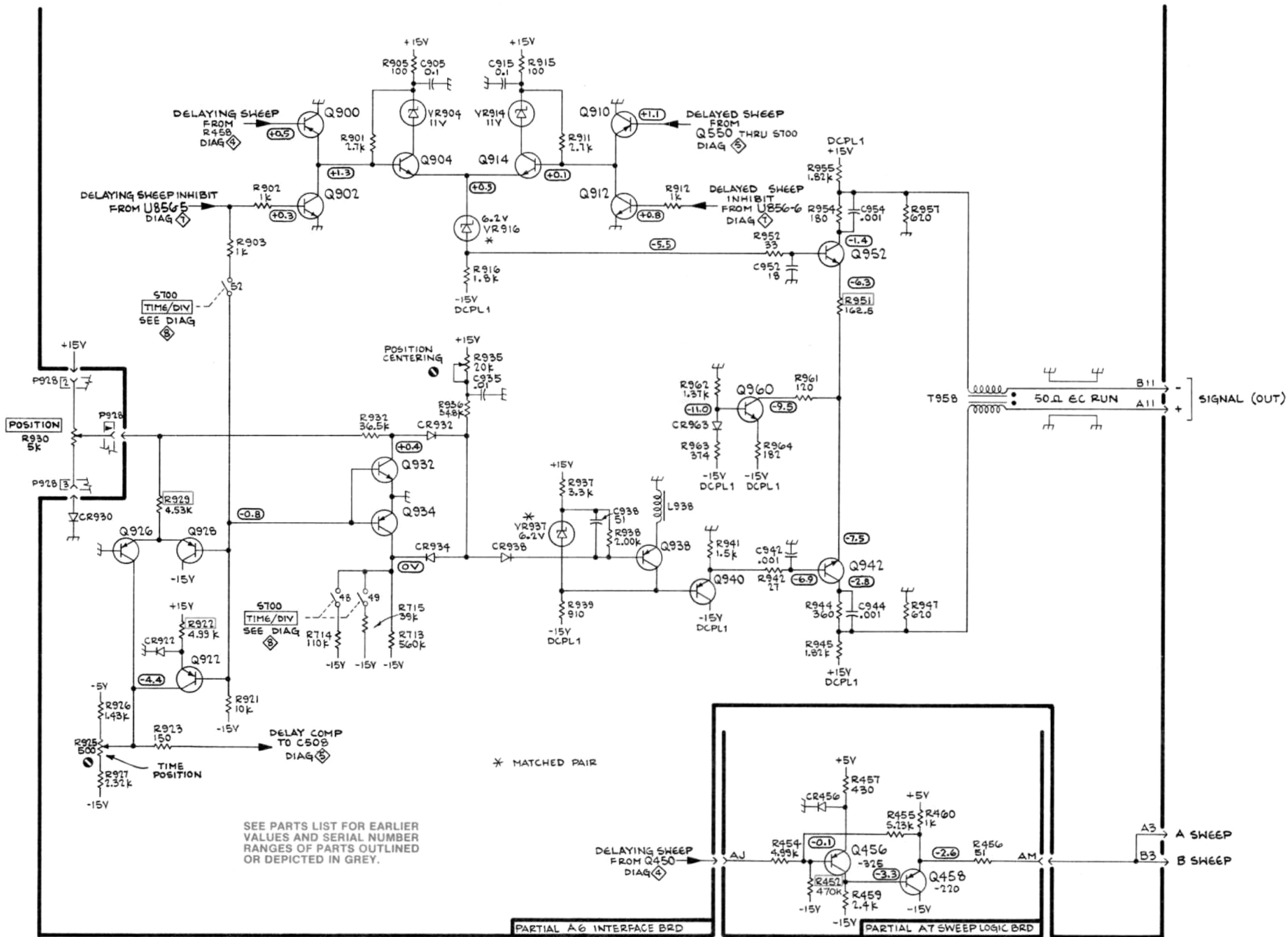

SEE PARTS LIST FOR SEMICONDUCTOR TYPES.

REV. C, SEP 1979

1751-33

OUTPUT AMP



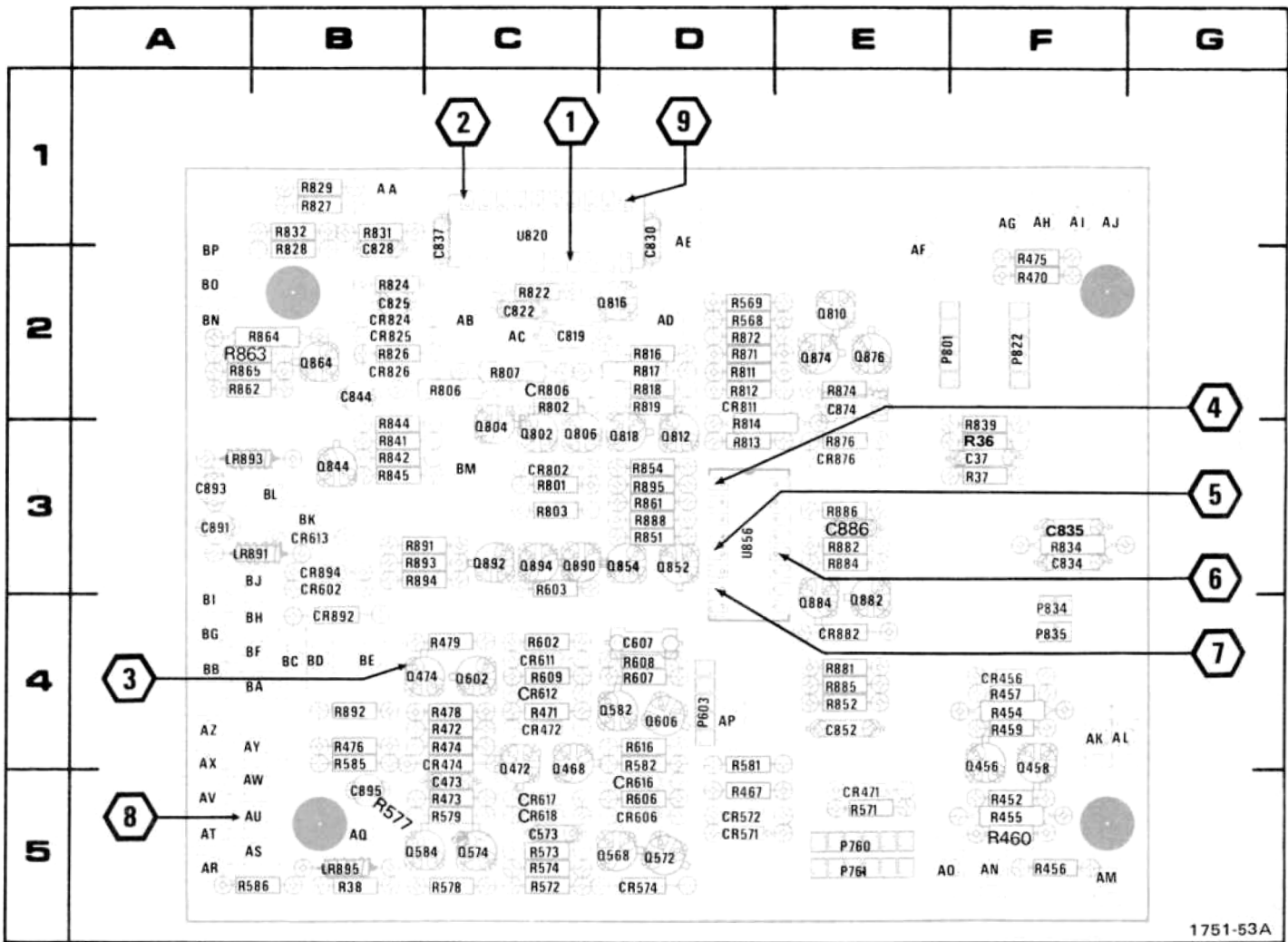

1751-53A

R477 located on back of board.

Fig. 8-15. A7-Logic Circuit Board (SN B059999 & below).

CKT NO	GRID LOC	CKT NO	GRID LOC	CKT NO	GRID LOC	CKT NO	GRID LOC	CKT NO	GRID LOC	CKT NO	GRID LOC
C37	3F	CR613	3B	Q468	4C	R38	5B	R586	5B	R834	3F
C473	5C	CR616	5D	Q472	4C	R452	5F	R602	4C	U820	1C
C573	5C	CR617	5C	Q474	4C	R454	4F	R603	3C	U856	3D
C607	4D	CR618	5C	Q568	5D	R455	5F	R606	5D	R839	3F
C819	2C	CR802	3C	Q572	5D	R456	5F	R607	4D	R841	3B
C822	2C	CR806	2C	Q574	5C	R457	4F	R608	4D	R842	3B
C825	2B	CR811	2D	Q582	4D	R459	4F	R609	5C	R844	3B
C828	2B	CR824	2B	Q584	5B	R460	5F	R613	2B	R845	3B
C834	3F	CR825	2B	Q602	4C	R467	5D	R616	4D	R851	3D
C835	3F	CR826	2B	Q606	4D	R470	2F	R801	3C	R852	4E
C837	1C	CR835	3F	Q802	3C	R471	4C	R802	2C	R854	3D
C844	2B	CR876	3E	Q804	3C	R472	4C	R802	3C	R861	3D
C852	4E	CR882	4E	Q806	3C	R473	5C	R806	2C	R862	2A
C874	2E	CR892	4B	Q810	2E	R474	4C	R807	2C	R863	2A
C886	3E	CR894	3B	Q812	3D	R475	2F	R811	2D	R864	2B
C891	3A	LR891	3B	Q816	2D	R476	4B	R812	2D	R865	2A
C893	3A	LR893	3A	Q818	3D	R478	4C	R813	3D	R871	2D
C895	5B	LR895	5B	Q844	3B	R479	4C	R814	3D	R872	2D
CR456	4F	P603	4D	Q852	3D	R568	2D	R816	2D	R874	2E
CR471	5E	P760	5E	Q854	3D	R569	2D	R817	2D	R876	3E
CR472	4C	P761	5E	Q864	2B	R571	5E	R818	2D	R881	4E
CR474	4C	P801	2E	Q874	2E	R572	5C	R819	2D	R882	3E
CR571	5D	P822	2F	Q876	2E	R573	5C	R822	2C	R884	3E
CR572	5D	P834	4F	Q882	4E	R574	5C	R824	2B	R885	4E
CR574	5D	P835	4F	Q884	4E	R575	5C	R826	2B	R886	3E
CR602	3B	Q456	4F	Q890	3C	R577	5B	R827	1B	R888	3D
CR606	5D	Q458	4F	Q892	3C	R578	5C	R828	2B	R891	3B
CR611	4C			Q894	3C	R579	5C	R829	1B	R892	4B
CR612	4C			R36	3F	R581	4D	R831	1B	R893	3B
				R37	3F	R582	4D	R832	1B	R894	3B
						R585	4B			R895	3D

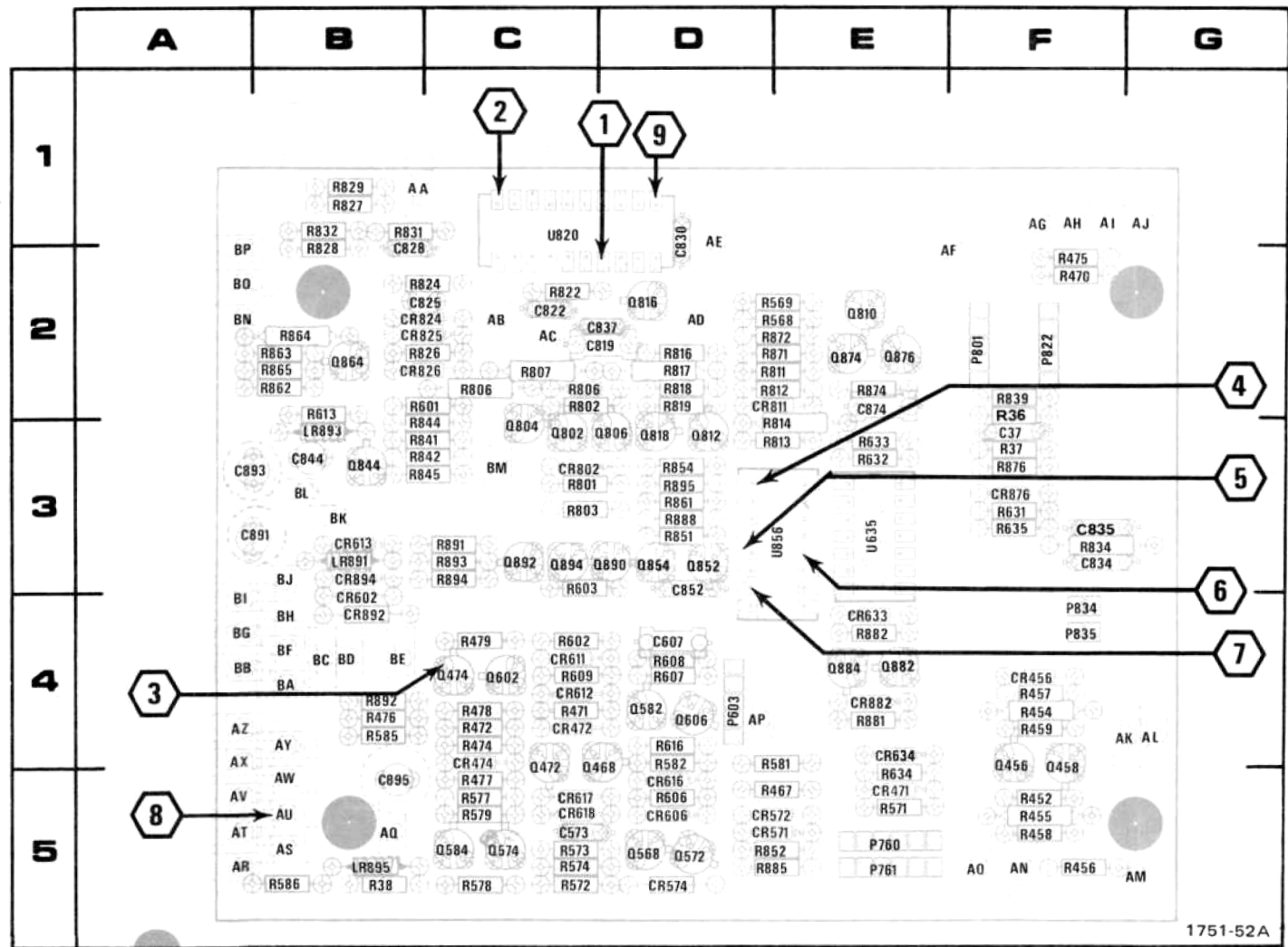

1751-52A

Fig. 8-16. A7-Logic Circuit Board (SN B060000 & up).

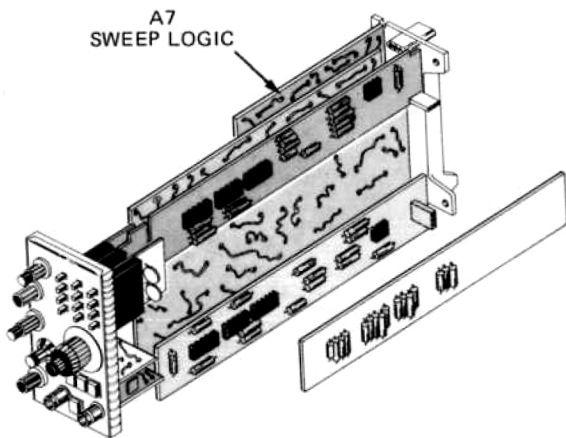

REV JAN 1982

CKT NO	GRID LOC	CKT NO	GRID LOC	CKT NO	GRID LOC	CKT NO	GRID LOC	CKT NO	GRID LOC	CKT NO	GRID LOC	CKT NO	GRID LOC
C37	3F	CR613	3B	Q456	4F	R37	3F	R585	4B	R824	2B	R886	5D
C473	5C	CR616	5D	Q458	4F	R38	5B	R586	5B	R826	2B	R888	3D
C573	5C	CR617	5C	Q468	4C	R452	5F	R601	2B	R827	1B	R891	3B
C607	4D	CR618	5C	Q472	4C	R454	4F	R602	4C	R828	2B	R892	4B
C819	2C	CR633	4E	Q474	4C	R455	5F	R603	3C	R829	1B	R893	3B
C822	2C	CR634	4E	Q568	5D	R456	5F	R606	5D	R831	1B	R894	3B
C825	2B	CR802	3C	Q572	5D	R457	4F	R607	4D	R832	1B	R895	3D
C828	2B	CR806	2C	Q574	5C	R459	4F	R608	4D	R834	3F		
C830	1D	CR811	2D	Q582	4D	R460	5F	R609	5C			U635	3E
C834	3F	CR824	2B	Q584	5B	R467	5D	R613	2B	R839	2F	U820	1D
C835	3F	CR825	2B	Q602	4C	R470	2F	R616	4D	R841	3B	U856	3D
C837	2C	CR826	2B	Q606	4D	R471	4C	R631	3F	R842	3B		
C844	3B	CR835	3F	Q802	3C	R472	4C	R632	3E	R844	3B		
C852	4E	CR876	3F	Q804	3C	R473	5C	R633	3E	R845	3B		
C874	2E	CR882	4E	Q806	3C	R474	4C	R634	4E	R851	3D		
C886	3E	CR892	4B	Q810	2E	R475	2F	R635	3F	R852	5D		
C891	3A	CR894	3B	Q812	3D	R476	4B	R801	3C	R854	3D		
C893	3A			Q816	2D	R477	5C	R802	2C	R861	3D		
C895	5B	LR891	3B	Q818	3D	R478	4C	R802	3C	R862	2A		
		LR893	3B	Q844	3B	R479	4C	R806	2C	R863	2A		
		LR895	5B	Q852	3D	R568	2D	R807	2C	R864	2B		
CR456	4F			Q854	3D	R571	5E	R811	2D	R865	2A		
CR471	5E			Q864	2B	R572	5C	R812	2D	R871	2D		
CR472	4C	P603	4D	Q874	2E	R573	5C	R813	3D	R872	2D		
CR474	5C	P760	5E	Q876	2E	R574	5C	R814	3D	R874	2E		
CR571	5D	P761	5E	Q882	4E	R577	5C	R816	2D	R876	3F		
CR572	5D	P822	2F	Q884	4E	R578	5C	R817	2D	R881	4E		
CR574	5D	P834	4F	Q890	3C	R579	5C	R818	2D	R882	4E		
CR602	4B	P835	4F	Q892	3C	R581	4D	R819	2D	R884	3E		
CR606	5D			Q894	3C	R582	4D	R822	2C	R885	4E		
CR611	4C			R36	3F								
CR612	4C												

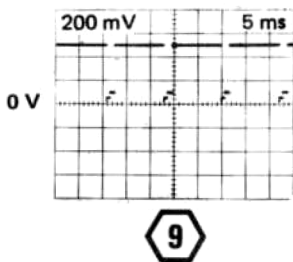
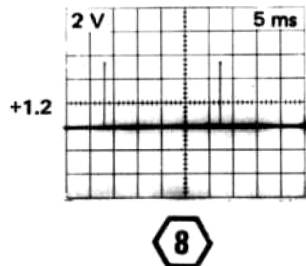
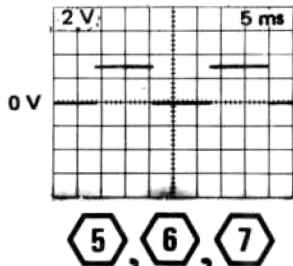
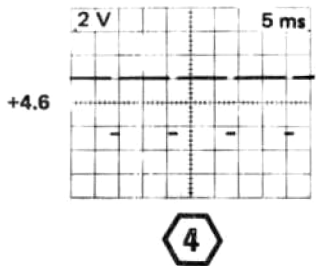
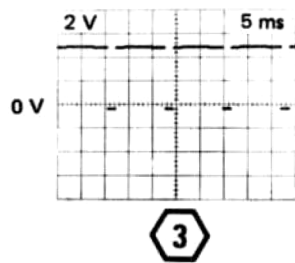
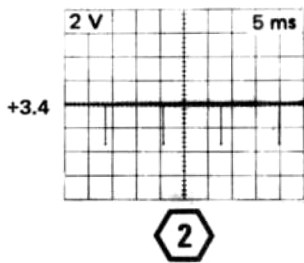
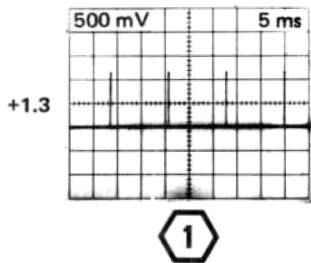

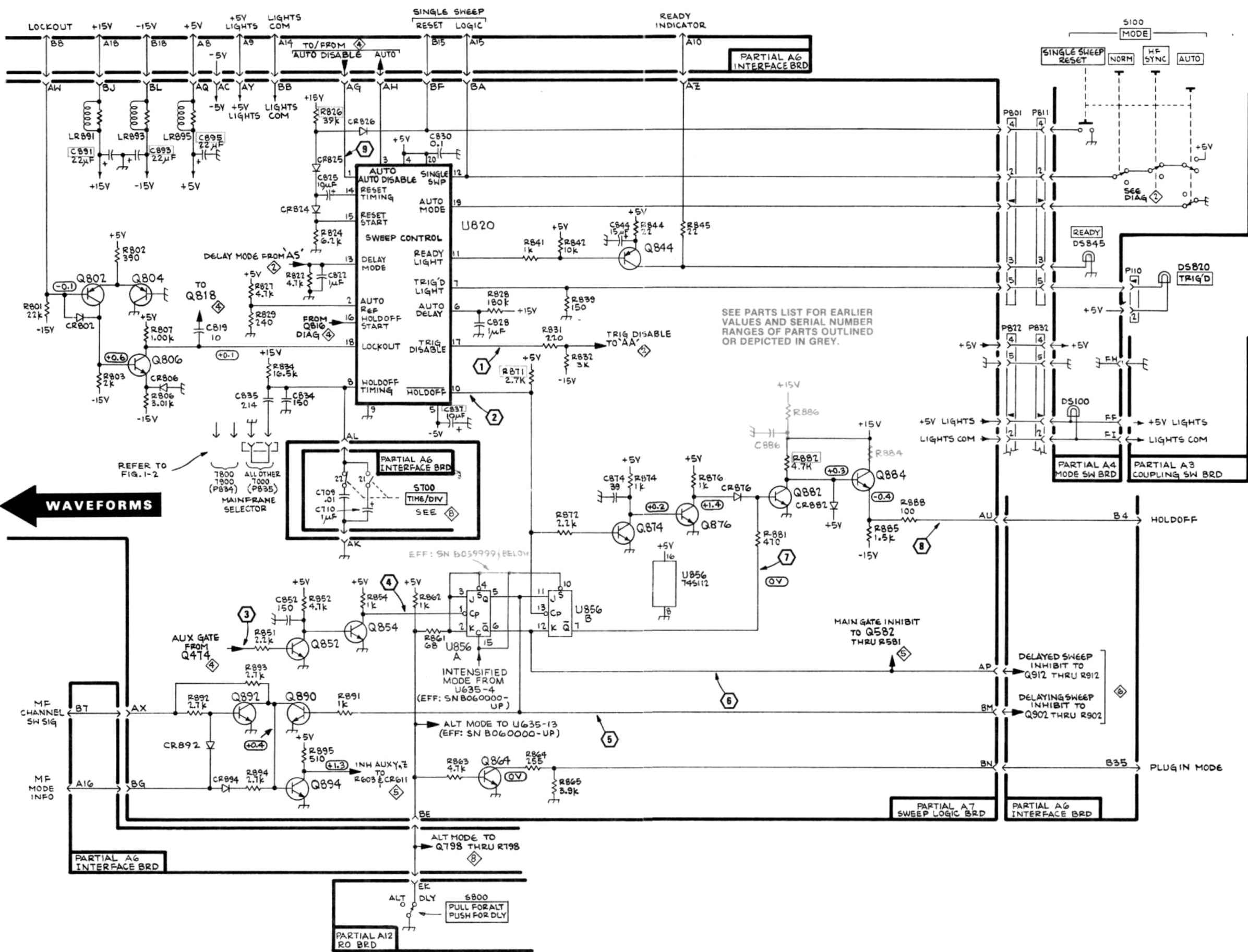

SEE PARTS LIST FOR EARLIER VALUES AND SERIAL NUMBER RANGES OF PARTS OUTLINED OR DEPICTED IN GREY.

REFER TO FIG. 1-2

← WAVEFORMS

PARTIAL A12 KRO BRD

SEE PARTS LIST FOR EARLIER VALUES AND SERIAL NUMBER RANGES OF PARTS OUTLINED OR DEPICTED IN GREY.

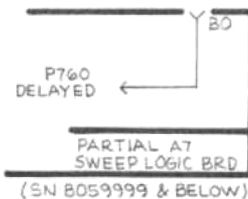

PARTIAL A7 SWEEP LOGIC BRD

PARTIAL A9 INTERFACE BRD

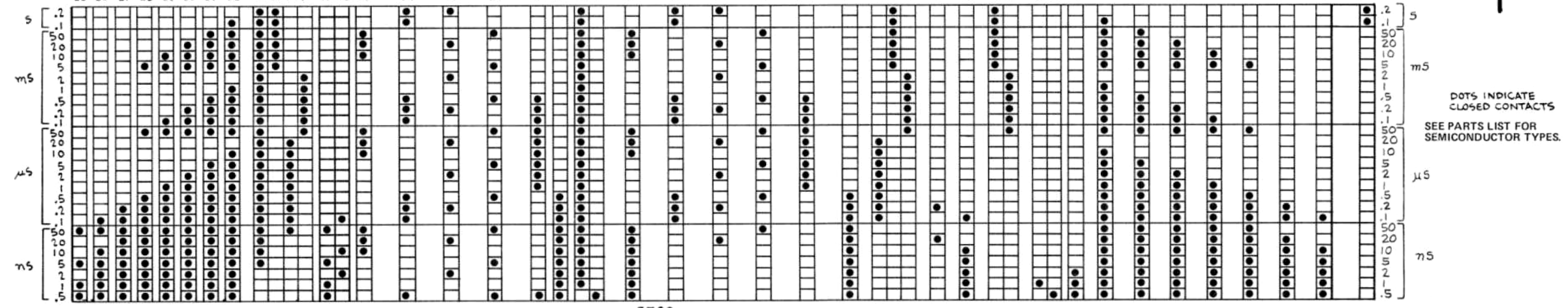
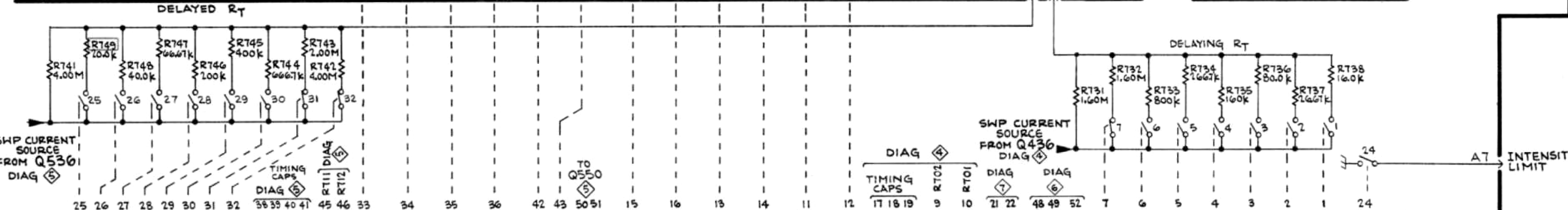
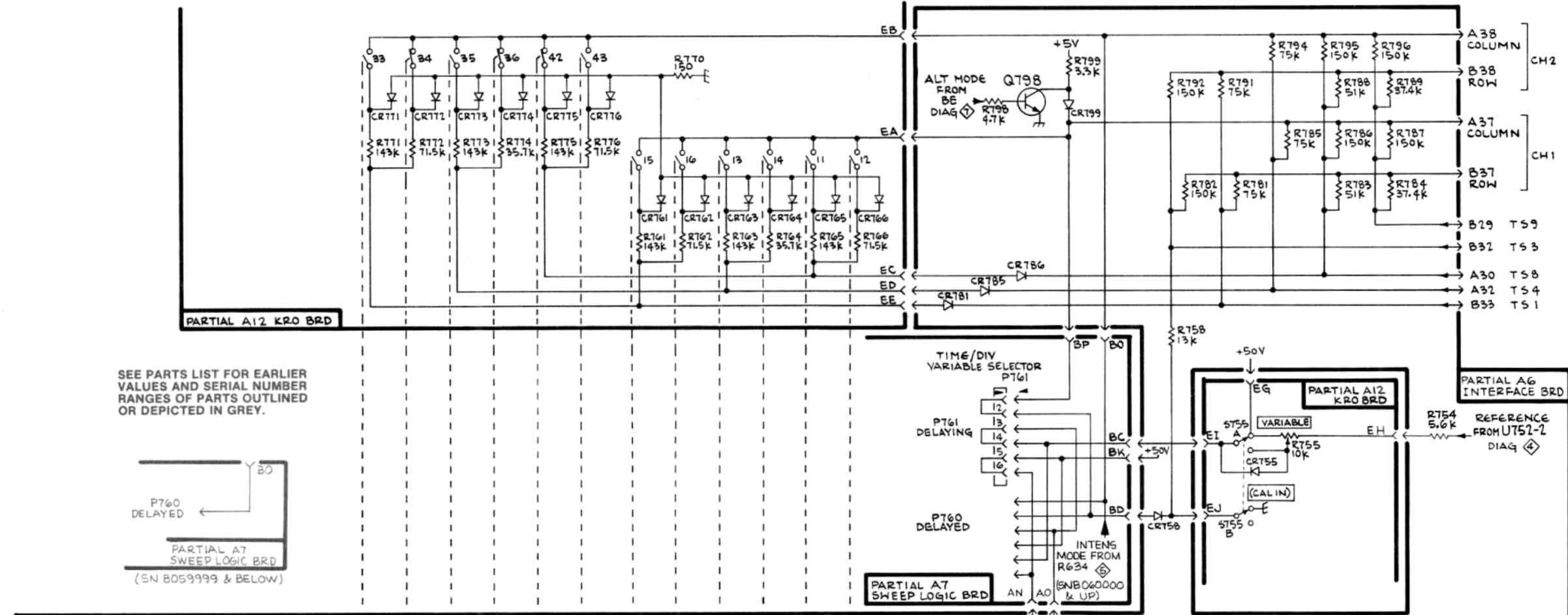

DLY'D TIME/DIV (DELAYED SWEEP)
SHOWN IN 0.5 mS POSITION

TIME/DIV OR DLY TIME

DLY TIME / DIV (DELAYING SWEEP)
SHOWN IN 1mS POSITION

TIMING & READOUT SWITCH

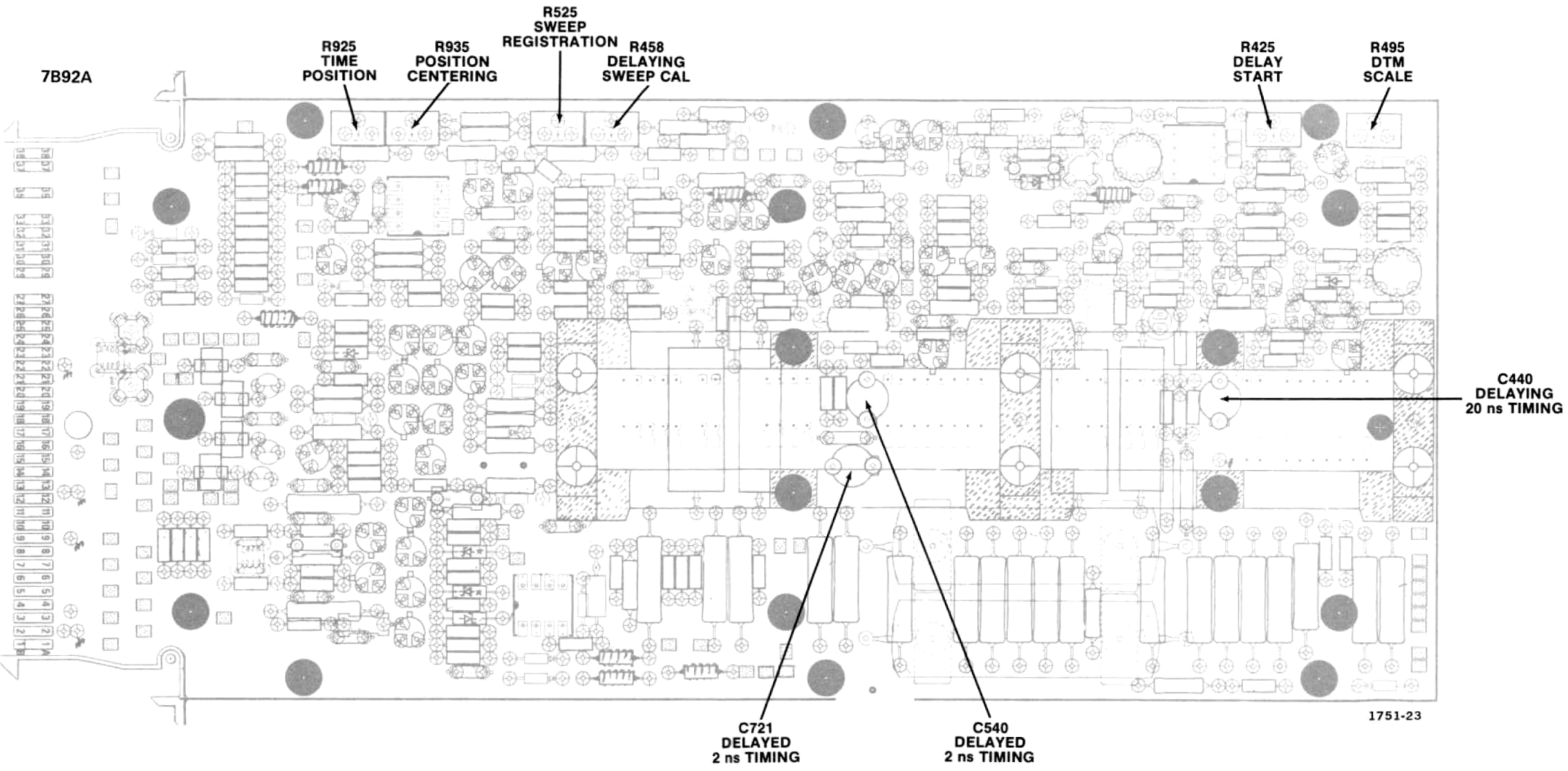

Fig. 8-18. Sweep Adjustment Locations.

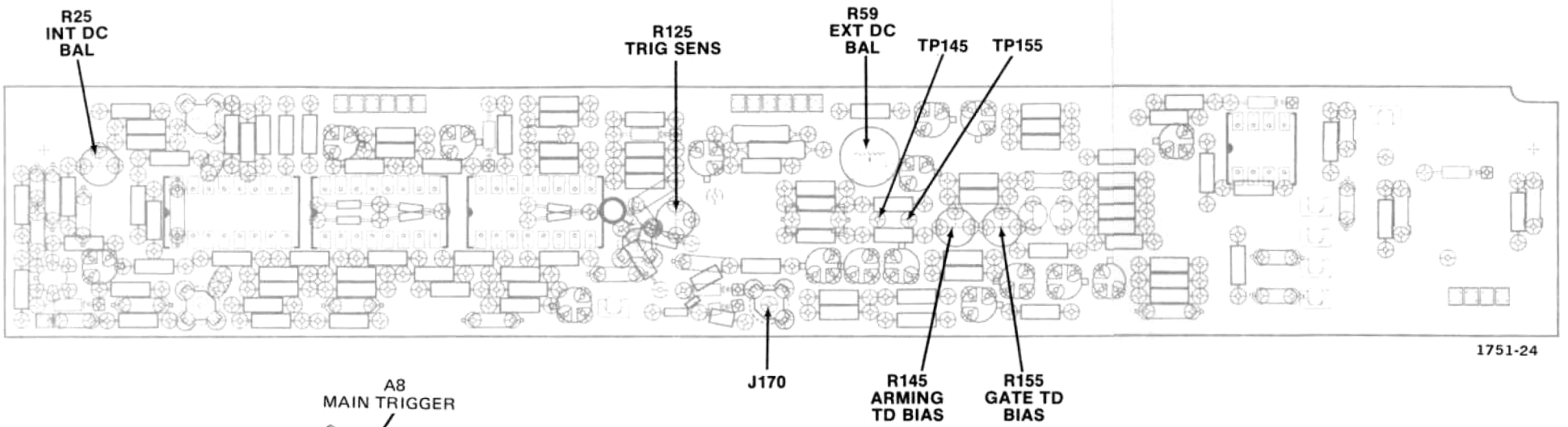

Fig. 8-19. Main Trigger Adjustment Location (SN B069999 & below).

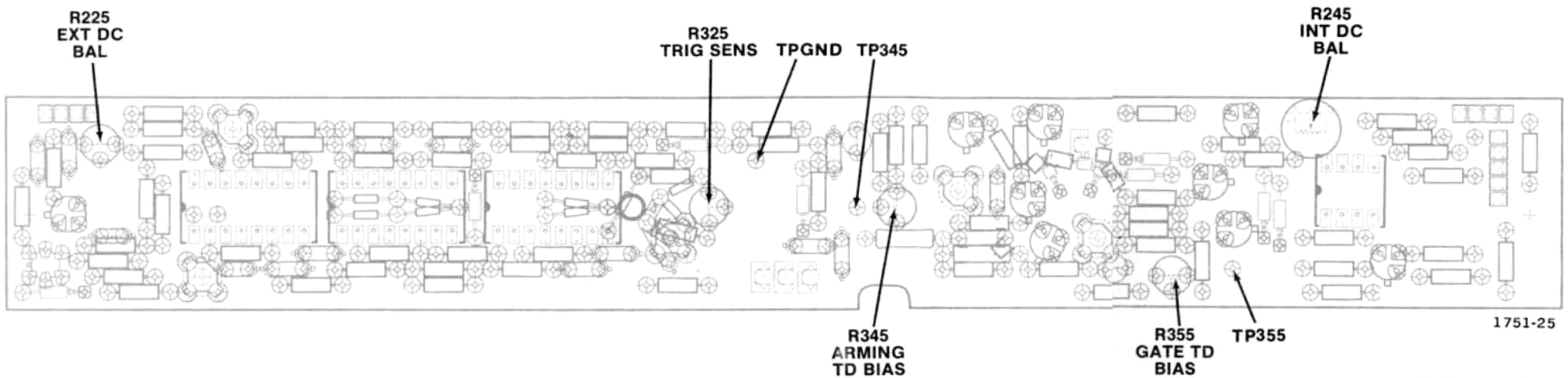
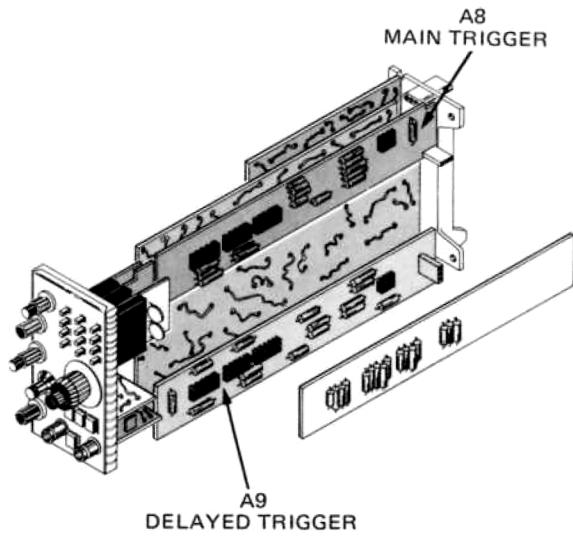
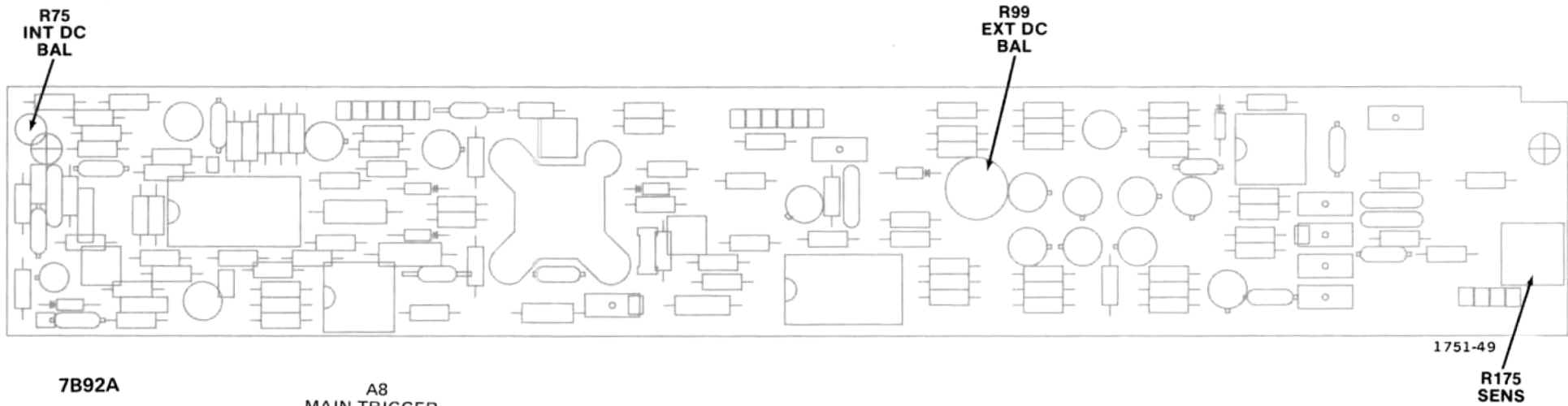

Fig. 8-20. Delayed Trigger Adjustment Location (SN B069999 & below).



7B92A

A8
MAIN TRIGGER

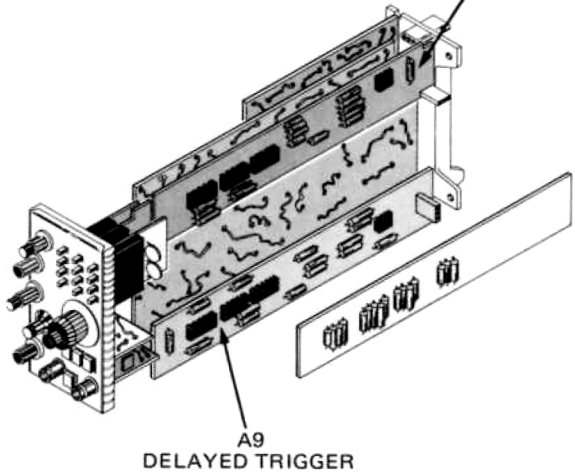

Fig. 8-21. Main Trigger Adjustment Location (SN B070000 & up).

REV A SEP 1979

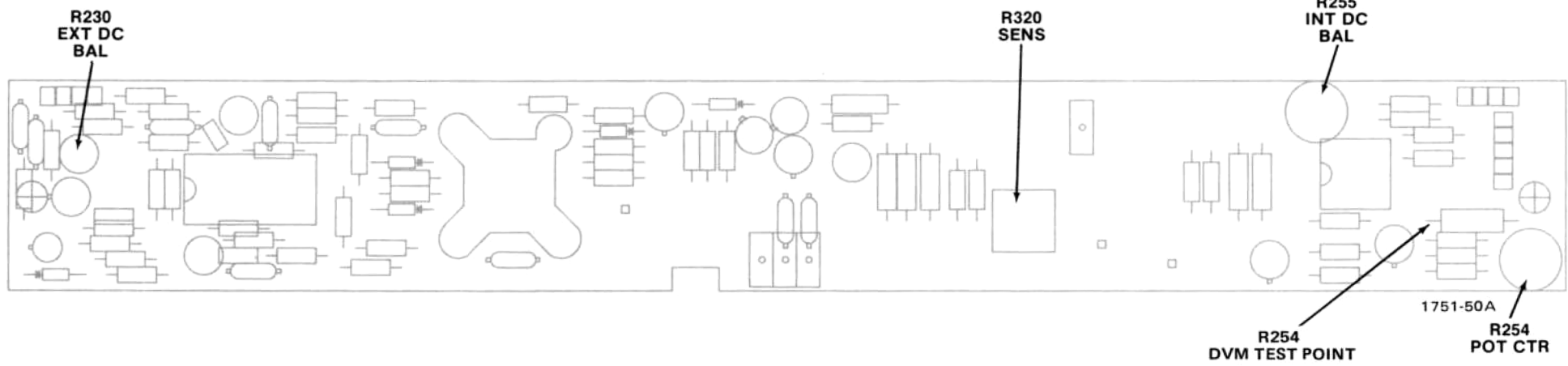

Fig. 8-22. Delayed Trigger Adjustment Location (SN B070000 & up).

REPLACEABLE MECHANICAL PARTS

PARTS ORDERING INFORMATION

Replacement parts are available from or through your local Tektronix, Inc. Field Office or representative.

Changes to Tektronix instruments are sometimes made to accommodate improved components as they become available, and to give you the benefit of the latest circuit improvements developed in our engineering department. It is therefore important, when ordering parts, to include the following information in your order: Part number, instrument type or number, serial number, and modification number if applicable.

If a part you have ordered has been replaced with a new or improved part, your local Tektronix, Inc. Field Office or representative will contact you concerning any change in part number.

Change information, if any, is located at the rear of this manual.

SPECIAL NOTES AND SYMBOLS

- X000 Part first added at this serial number
- 00X Part removed after this serial number

FIGURE AND INDEX NUMBERS

Items in this section are referenced by figure and index numbers to the illustrations.

INDENTATION SYSTEM

This mechanical parts list is indented to indicate item relationships. Following is an example of the indentation system used in the description column.

```

1 2 3 4 5           Name & Description
Assembly and/or Component
Attaching parts for Assembly and/or Component
    - - - * - - -
Detail Part of Assembly and/or Component
Attaching parts for Detail Part
    - - - * - - -
Parts of Detail Part
Attaching parts for Parts of Detail Part
    - - - * - - -
    
```

Attaching Parts always appear in the same indentation as the item it mounts, while the detail parts are indented to the right. Indented items are part of, and included with, the next higher indentation. The separation symbol - - - * - - - indicates the end of attaching parts.

Attaching parts must be purchased separately, unless otherwise specified.

ITEM NAME

In the Parts List, an Item Name is separated from the description by a colon (:). Because of space limitations an Item Name may sometimes appear as incomplete. For further Item Name identification, the U.S. Federal Cataloging Handbook H6-1 can be utilized where possible.

ABBREVIATIONS

..	INCH	ELCTRN	ELECTRON	IN	INCH	SE	SINGLE END
#	NUMBER SIZE	ELEC	ELECTRICAL	INCAND	INCANDESCENT	SECT	SECTION
ACTR	ACTUATOR	ELCTLT	ELECTROLYTIC	INSUL	INSULATOR	SEMICOND	SEMICONDUCTOR
ADPTR	ADAPTER	ELEM	ELEMENT	INTL	INTERNAL	SHLD	SHIELD
ALIGN	ALIGNMENT	EPL	ELECTRICAL PARTS LIST	LPHLDR	LAMPHOLDER	SHLDR	SHOULDERED
AL	ALUMINUM	EQPT	EQUIPMENT	MACH	MACHINE	SKT	SOCKET
ASSEM	ASSEMBLED	EXT	EXTERNAL	MECH	MECHANICAL	SL	SLIDE
ASSY	ASSEMBLY	FIL	FILLISTER HEAD	MTG	MOUNTING	SLFLKG	SELF-LOCKING
ATTEN	ATTENUATOR	FLEX	FLEXIBLE	NIP	NIPPLE	SLVG	SLEEVING
AWG	AMERICAN WIRE GAGE	FLH	FLAT HEAD	NON WIRE	NOT WIRE WOUND	SPR	SPRING
BD	BOARD	FLTR	FILTER	OBD	ORDER BY DESCRIPTION	SQ	SQUARE
BRKT	BRACKET	FR	FRAME or FRONT	OD	OUTSIDE DIAMETER	SST	STAINLESS STEEL
BRS	BRASS	FSTNR	FASTENER	OVH	OVAL HEAD	STL	STEEL
BRZ	BRONZE	FT	FOOT	PH BRZ	PHOSPHOR BRONZE	SW	SWITCH
BSHG	BUSHING	FXD	FIXED	PL	PLAIN or PLATE	T	TUBE
CAB	CABINET	GSKT	GASKET	PLSTC	PLASTIC	TERM	TERMINAL
CAP	CAPACITOR	HDL	HANDLE	PN	PART NUMBER	THD	THREAD
CER	CERAMIC	HEX	HEXAGON	PNH	PAN HEAD	THK	THICK
CHAS	CHASSIS	HEX HD	HEXAGONAL HEAD	PWR	POWER	TNSN	TENSION
CKT	CIRCUIT	HEX SOC	HEXAGONAL SOCKET	RCPT	RECEPTACLE	TPG	TAPPING
COMP	COMPOSITION	HLCPS	HELICAL COMPRESSION	RES	RESISTOR	TRH	TRUSS HEAD
CONN	CONNECTOR	HLEXT	HELICAL EXTENSION	RGD	RIGID	V	VOLTAGE
COV	COVER	HV	HIGH VOLTAGE	RLF	RELIEF	VAR	VARIABLE
CPLG	COUPLING	IC	INTEGRATED CIRCUIT	RTNR	RETAINER	W/	WITH
CRT	CATHODE RAY TUBE	ID	INSIDE DIAMETER	SCH	SOCKET HEAD	WSHR	WASHER
DEG	DEGREE	IDENT	IDENTIFICATION	SCOPE	OSCILLOSCOPE	XFMR	TRANSFORMER
DWR	DRAWER	IMPLR	IMPELLER	SCR	SCREW	XSTR	TRANSISTOR

CROSS INDEX - MFR. CODE NUMBER TO MANUFACTURER

Mfr. Code	Manufacturer	Address	City, State, Zip Code
00779	AMP INC	P O BOX 3608	HARRISBURG PA 17105
01536	TEXTRON INC CAMCAR DIV	1818 CHRISTINA ST	ROCKFORD IL 61108
02114	SEMS PRODUCTS UNIT AMPEREX ELECTRONIC CORP FERROXCUBE DIV	5083 KINGS HWY	SAUGERTIES NY 12477
05129	KILO ENGINEERING CO	2015 D	LA VERNE CA 91750
07416	NELSON NAME PLATE CO	3191 CASITAS	LOS ANGELES CA 90039
08261	SPECTRA-STRIP AN ELTRA CO	7100 LAMPSON AVE	GARDEN GROVE CA 92642
09922	BURNDY CORP	RICHARDS AVE	NORWALK CT 06852
11897	PLASTIGLIDE MFG CORP	2701 W EL SEGUNDO BLVD	HAWTHORNE CA 90250
12327	FREWAY CORP	9301 ALLEN DR	CLEVELAND OH 44125
22526	DU PONT E I DE NEMOURS AND CO INC DU PONT CONNECTOR SYSTEMS	30 HUNTER LANE	CAMP HILL PA 17011
22599	AMERACE CORP ESNA DIV	15201 BURBANK BLVD SUITE C	VAN NUYS CA 91411
24546	CORNING GLASS WORKS	550 HIGH ST	BRADFORD PA 16701
24931	SPECIALTY CONNECTOR CO INC	2620 ENDRESS PLACE P O BOX D	GREENWOOD IN 46142
28520	HEYCO MOLDED PRODUCTS	147 MICHIGAN AVE P O BOX 160	KENILWORTH NJ 07033
46384	PENN ENGINEERING AND MFG CORP	P O BOX 311	DOYLESTOWN PA 18901
56878	SPS TECHNOLOGIES INC	HIGHLAND AVE	JENKINTOWN PA 19046
71124	BRAND-REX CO	RT 32 P O BOX 498	WILLIMANTIC CT 06226
73743	FISCHER SPECIAL MFG CO	446 MORGAN ST	CINCINNATI OH 45206
74445	HOLO-KROME CO	31 BROOK ST	WEST HARTFORD CT 06110
77900	SHAKEPROOF DIV OF ILLINOIS TOOL WORKS	SAINT CHARLES RD	ELGIN IL 60120
78189	ILLINOIS TOOL WORKS INC SHAKEPROOF DIVISION	ST CHARLES ROAD	ELGIN IL 60120
78488	STACKPOLE CARBON CO		ST MARYS PA 15857
79136	WALDES KOHINOOR INC	47-16 AUSTEL PLACE	LONG ISLAND CITY NY 11101
80009	TEKTRONIX INC	4900 S W GRIFFITH DR P O BOX 500	BEAVERTON OR 97077
83486	ELCO INDUSTRIES INC	1101 SAMUELSON RD	ROCKFORD IL 61101
87308	N L INDUSTRIES INC N L FASTENERS	BARKLEY RD P O BOX 1360	STATESVILLE NC 28677
91260	CONNOR SPRING AND MFG CO	1729 JUNCTION AVE	SAN JOSE CA 95112
93907	TEXTRON INC CAMCAR DIV	600 18TH AVE	ROCKFORD IL 61101
TK0392	NORTHWEST FASTENER SALES INC	7923 SW CIRRRUS DRIVE	BEAVERTON OR 97005
TK0433	PORTLAND SCREW CO	6520 N BASIN	PORTLAND OR 97217
TK0435	LEWIS SCREW CO	4114 S PEORIA	CHICAGO IL 60609
TK0507	O HARA METAL PRODUCTS CO	542 BRANNAN ST	SAN FRANCISCO CA 94107
TK1326	NORTHWEST FOURSLIDE INC	5858 WILLOW LANE	LAKE OSWEGO OR 97034
TK1375	ESAM	PO BOX 376	GRANTS PASS OR 97526

Fig. & Index No.	Tektronix Part No.	Serial/Assembly No.		Qty	12345 Name & Description	Mfr.	
		Effective	Dscont			Code	Mfr. Part No.
1-1	366-1168-00			1	KNOB:RED,0.084 ID X 0.392 OD X 0.4 H	80009	366-1168-00
	213-0153-00			1	.SETSCREW:5-40 X 0.125,STL	TK0392	ORDER BY DESCR
-2	366-1321-01			1	KNOB:GY,ALT,0.203 ID X 0.976 OD X 0.89 H	80009	366-1321-01
	213-0890-00			2	.SETSCREW:6-32 X 0.25 L,STL	56878	ORDER BY DESCR
-3	354-0410-00			1	RING,KNOB SKIRT:CLEAR,1.0 OD	80009	354-0410-00
	213-0004-00			1	.SETSCREW:6-32 X 0.188,STL	74445	ORDER BY DESCR
-4	384-1087-00			1	SHAFT,PUSH,ACTR:0.76 L X 0.065 STEPPED	80009	384-1087-00
-5	401-0126-00			1	BRG,KNOB SKIRT:DELRLIN 0.861 ID X 0.975 OD X 0.125	80009	401-0126-00
-6	366-1391-02			2	KNOB:LT GY,0.081 ID X 0.28 OD X 0.32 H	80009	366-1391-02
	213-0140-00			2	.SETSCREW:2-56 X 0.094,STL	TK0433	ORDER BY DESCR
-7	366-1077-00			2	KNOB:GRAY W/SETSCREW	80009	366-1077-00
	213-0153-00			2	.SETSCREW:5-40 X 0.125,STL	TK0392	ORDER BY DESCR
-8	366-1189-00			2	KNOB:GY,0.127 ID X 0.5 OD X 0.531	80009	366-1189-00
	213-0153-00			1	.SETSCREW:5-40 X 0.125,STL	TK0392	ORDER BY DESCR
-9	214-1597-00			1	ADAPTER,SW ACTR:0.252 ID X 0.75 OD X 0.425	80009	214-1597-00
-10	131-0106-02			2	CONN,RCPT,ELEC:BNC,FEMALE (ATTACHING PARTS)	24931	28JR178-1
-11	210-0978-00			2	WASHER,FLAT:0.375 ID X 0.5 OD X 0.024,STL (END ATTACHING PARTS)	12327	ORDER BY DESCR
-12	366-1257-90			1	PUSH BUTTON:SIL GY,+	80009	366-1257-90
-13	366-1257-91			1	PUSH BUTTON:SIL GY,AC DC	80009	366-1257-91
-14	366-1257-92			1	PUSH BUTTON:SIL GY,INT EXT	80009	366-1257-92
-15	366-1489-73			1	PUSH BUTTON:SIL GY,TERM	80009	366-1489-73
-16	426-0681-00			4	FRAME,PUSH BTN:	80009	426-0681-00
-17	366-1058-61			1	KNOB:GRAY,7B92A (ATTACHING PARTS)	80009	366-1058-61
-18	214-1095-00			1	PIN,SPRING:0.187 L X 0.094 OD,STL,CD PL (END ATTACHING PARTS)	22599	52-022-094-0187
-19	105-0076-02	B010100	B093909	1	RELEASE BAR,LCH:PLUG-IN UNIT	80009	105-0076-02
	105-0076-04	B093910		1	RELEASE BAR,LCH:PLUG-IN UNIT	80009	105-0076-04
-20	214-1280-00			1	SPRING,HLCPS:0.14 OD X 1.126 L,TWIST LOOP	91260	ORDER BY DESCR
-21	358-0378-00	B010100	B075999	2	BUSHING,SLV:0.131 ID X 0.18 OD X 0.125 L	80009	358-0378-00
	358-0599-00	B076000		2	BUSHING,SLEEVE:0.125 ID X 0.25 OD X 0.234	28520	B-187-125
-22	333-1886-00	B010100	B059999	1	PANEL,FRONT:	80009	333-1886-00
	333-1886-01	B060000		1	PANEL,FRONT:	80009	333-1886-01
-23	337-1064-04	B010100	B095126	1	SHIELD,ELEC:SIDE FOR PLUG-IN UNIT	80009	337-1064-04
	337-1064-12	B095127		1	SHIELD,ELEC:SIDE FOR PLUG-IN UNIT	80009	337-1064-12
-24	337-1163-02			1	SHIELD,ELEC:LEFT SIDE	80009	337-1163-02
-25	337-1167-00			1	SHIELD,ELEC:	80009	337-1167-00
-26	331-0247-00			1	DIAL,CONTROL:10 TURNS W/O BRAKE	05129	771-S-1
-27	200-0935-00			1	BASE,LAMPHOLDER:0.29 OD X 0.19 L,BK PLSTC	80009	200-0935-00
-28	378-0602-00			1	LENS,LIGHT:GREEN	80009	378-0602-00
-29	352-0157-00			1	LAMPHOLDER:(1)T-2 UNBASED,WHITE	80009	352-0157-00
-30	-----			1	RES.,VARIABLE:(SEE R50,S50 REPL) (ATTACHING PARTS)		
-31	210-0583-00			1	NUT,PLAIN,HEX:0.25-32 X 0.312,BRS CD PL (END ATTACHING PARTS)	73743	2X-20319-402
-32	-----			1	RES.,VARIABLE:(SEE R930 REPL) (ATTACHING PARTS)		
	210-0583-00			1	NUT,PLAIN,HEX:0.25-32 X 0.312,BRS CD PL (END ATTACHING PARTS)	73743	2X-20319-402
-33	-----			1	RES.,VARIABLE:(SEE R600,R605 REPL) (ATTACHING PARTS)		
	210-0583-00			1	NUT,PLAIN,HEX:0.25-32 X 0.312,BRS CD PL (END ATTACHING PARTS)	73743	2X-20319-402
-34	-----			1	RES.,VARIABLE:(SEE R250 REPL) (ATTACHING PARTS)		
	210-0583-00			1	NUT,PLAIN,HEX:0.25-32 X 0.312,BRS CD PL (END ATTACHING PARTS)	73743	2X-20319-402
-35	-----			1	RES.,VARIABLE:(SEE R490 REPL)		
	211-0008-00	B075710		10	SCREW,MACHINE:4-40 X 0.25,PNH,STL	93907	ORDER BY DESCR
	211-0159-00	B075710		2	SCREW,MACHINE:2-56 X 0.375,PNH,STL	TK0435	1183-302
	211-0244-00	B075710	B092199	8	SCR,ASSEM WSHR:4-40 X 0.312,PNH STL	01536	ORDER BY DESCR
	211-0292-00	B092200		8	SCR,ASSEM WSHR:4-40 X 0.29,PNH,BRS NI PL	78189	51-040445-01
	210-0046-00	B075710		5	WASHER,LOCK:0.261 ID,INTL,0.018 THK,STL	77900	1214-05-00-0541C
-36	-----			1	CKT BOARD ASSY:TRIG MODE(SEE A4 REPL) (ATTACHING PARTS)		

Replaceable Mechanical Parts - 7892A

Fig. & Index No.	Tektronix Part No.	Serial/Assembly No. Effective	Discont	Qty	12345 Name & Description	Mfr. Code	Mfr. Part No.
1-37	211-0156-00			2	SCREW,MACHINE:1-72 X 0.250,FLH,82 DEG,STL (END ATTACHING PARTS)	93907	ORDER BY DESCR
-38	131-0608-00			14	.TERMINAL,PIN:0.365 L X 0.025 BRZ GLD PL	22526	48283-036
-39	136-0263-04			5	.SOCKET,PIN TERM:U/W 0.025 SQ PIN	22526	75377-001
-40	-----			1	CKT BOARD ASSY:COUPLING SW(SEE A3 REPL) (ATTACHING PARTS)		
	211-0156-00			2	SCREW,MACHINE:1-72 X 0.250,FLH,82 DEG,STL (END ATTACHING PARTS)	93907	ORDER BY DESCR
					CKT BOARD ASSY INCLUDES:		
-41	131-0593-00			5	.TERMINAL,PIN:1.15 L X 0.025 SQ BRS TIN PL	22526	47334
	131-0590-00			9	.TERMINAL,PIN:0.71 L X 0.025 SQ PH BRZ	22526	47331
-42	131-0608-00			11	.TERMINAL,PIN:0.365 L X 0.025 BRZ GLD PL	22526	48283-036
-43	-----			1	CKT BOARD ASSY:SOURCE SW(SEE A2 REPL) (ATTACHING PARTS)		
	211-0156-00			2	SCREW,MACHINE:1-72 X 0.250,FLH,82 DEG,STL (END ATTACHING PARTS)	93907	ORDER BY DESCR
					CKT BOARD ASSY INCLUDES:		
-44	136-0263-04			14	.SOCKET,PIN TERM:U/W 0.025 SQ PIN	22526	75377-001
-45	-----			1	RES.,VARIABLE:(SEE R615 REPL)		
-46	-----			1	RES.,VARIABLE:(SEE R750 REPL)		
-47	-----			1	CKT BD ASSY:DELAYED TRIGGER SW(SEE A5 REPL) (ATTACHING PARTS)		
-48	211-0001-00			2	SCREW,MACHINE:2-56 X 0.25,PNH,STL (END ATTACHING PARTS)	TK0435	ORDER BY DESCR
-49	220-0637-00			1	NUT BLOCK:2-56/4-40 X 1.050,AL (ATTACHING PARTS)	80009	220-0637-00
-50	211-0105-00			2	SCREW,MACHINE:4-40 X 0.188,FLH,100 DEG (END ATTACHING PARTS)	TK0435	ORDER BY DESCR
					CKT BOARD ASSY INCLUDES:		
-51	-----			1	.SWITCH,PUSH:(SEE S285 REPL)		
-52	131-0589-00			7	.TERMINAL,PIN:0.46 L X 0.025 SQ PH BRZ	22526	48283-029
-53	-----			1	CKT BOARD ASSY:EXTERNAL INPUT(SEE A1 REPL) (ATTACHING PARTS)		
-54	211-0001-00			2	SCREW,MACHINE:2-56 X 0.25,PNH,STL (END ATTACHING PARTS)	TK0435	ORDER BY DESCR
-55	220-0616-00			1	NUT BLOCK:(2)4-40/2-56 0.188,AL (ATTACHING PARTS)	80009	220-0616-00
-56	211-0105-00			2	SCREW,MACHINE:4-40 X 0.188,FLH,100 DEG (END ATTACHING PARTS)	TK0435	ORDER BY DESCR
					CKT BOARD ASSY INCLUDES:		
-57	131-0608-00			2	.TERMINAL,PIN:0.365 L X 0.025 BRZ GLD PL	22526	48283-036
-58	131-1003-00			2	.CONN,RCPT,ELEC:CKT BD MT,3 PRONG	80009	131-1003-00
-59	136-0252-07			2	.SOCKET,PIN CONN:W/O DIMPLE	22526	75060-012
-60	-----			1	.SWITCH,PUSH:(SEE S205 REPL)		
-61	348-0235-00			2	SHLD GSKT,ELEK:FINGER TYPE,4.734 L	80009	348-0235-00
-62	386-1447-76			1	SUBPANEL,FRONT: (ATTACHING PARTS)	80009	386-1447-76
-63	213-0192-00	B010100	B091699	4	SCREW,TPG,TF:6-32 X 0.5,SPCL TYPE,FILH,STL	87308	ORDER BY DESCR
	213-0793-00	B091700		4	SCREW,TPG,TF:6-32 X 0.4375,TAPTITE,FILH (END ATTACHING PARTS)	83486	239-006-406043
-64	-----			1	SWITCH,SENS:(SEE S490 REPL) (ATTACHING PARTS)		
-65	211-0185-00			2	SCREW,MACHINE:2-56 X 0.438,PNH,STL	TK0435	ORDER BY DESCR
-66	210-0405-00			2	NUT,PLAIN,HEX:2-56 X 0.188,BRS CD PL	73743	12157-50
-67	210-0850-00			3	WASHER,FLAT:0.093 ID X 0.281 OD X 0.02,STL	12327	ORDER BY DESCR
-68	210-0259-00			1	TERMINAL,LUG:0.099 ID,LOCKING,BRS CD PL (END ATTACHING PARTS)	80009	210-0259-00
-69	386-2839-00			1	PLATE,SW MTG:MICRO SWITCH (ATTACHING PARTS)	80009	386-2839-00
-70	211-0008-00			2	SCREW,MACHINE:4-40 X 0.25,PNH,STL (END ATTACHING PARTS)	93907	ORDER BY DESCR
-71	386-1402-00			1	PANEL,REAR: (ATTACHING PARTS)	80009	386-1402-00
-72	213-0192-00	B010100	B091699	4	SCREW,TPG,TF:6-32 X 0.5,SPCL TYPE,FILH,STL	87308	ORDER BY DESCR
	213-0793-00	B091700		4	SCREW,TPG,TF:6-32 X 0.4375,TAPTITE,FILH	83486	239-006-406043
-73	361-0326-00			1	SPACER,SLEEVE:0.1 L X 0.18 ID,AL (NO LONGER USED)	80009	361-0326-00

Fig. & Index No.	Tektronix Part No.	Serial/Assembly No.		Qty	12345 Name & Description	Mfr.	
		Effective	Discnt			Code	Mfr. Part No.
1-					(END ATTACHING PARTS)		
-74	-----			1	CKT BOARD ASSY:SWEEP LOGIC(SEE A7 REPL)		
					(ATTACHING PARTS)		
-75	211-0155-00			4	SCREW,EXT RLV:4-40 X 0.375,PNH,SST,POZ	80009	211-0155-00
					(END ATTACHING PARTS)		
					CKT BOARD ASSY INCLUDES:		
-76	131-0608-00			32	.TERMINAL,PIN:0.365 L X 0.025 BRZ GLD PL	22526	48283-036
-77	214-0579-00			1	.TERM,TEST POINT:BRS CD PL	80009	214-0579-00
-78	136-0252-00	B010100	B059999	44	.SOCKET,PIN TERM:U/W 0.019 DIA PINS	00779	2-330808-7
	136-0252-07	B060000		28	.SOCKET,PIN CONN:W/O DIMPLE	22526	75060-012
-79	136-0263-04			42	.SOCKET,PIN TERM:U/W 0.025 SQ PIN	22526	75377-001
-80	361-0238-00			4	.SPACER,POST:0.433 L,0.25 OD	80009	361-0238-00
-81	136-0350-00	B010100	B049999	28	.SKT,PL-IN ELEK:TRANSISTOR,3 CONTACT	80009	136-0350-00
-82	-----			1	CKT BOARD ASSY:MAIN TRIGGER(SEE A8 REPL)		
					(ATTACHING PARTS)		
-83	211-0155-00			3	SCREW,EXT RLV:4-40 X 0.375,PNH,SST,POZ	80009	211-0155-00
					(END ATTACHING PARTS)		
					CKT BOARD ASSY INCLUDES:		
-84	131-0608-00			17	.TERMINAL,PIN:0.365 L X 0.025 BRZ GLD PL	22526	48283-036
-85	131-1003-00	B010100	B069999	4	.CONN,RCPT,ELEC:CKT BD MT,3 PRONG	80009	131-1003-00
	131-1003-00	B070000		2	.CONN,RCPT,ELEC:CKT BD MT,3 PRONG	80009	131-1003-00
-86	136-0252-04	B010100	B069999	118	.SOCKET,PIN TERM:U/W 0.016-0.018 DIA PINS	22526	75060-007
	136-0252-07	B070000		67	.SOCKET,PIN CONN:W/O DIMPLE	22526	75060-012
-87	136-0263-04	B010100	B069999	6	.SOCKET,PIN TERM:U/W 0.025 SQ PIN	22526	75377-001
	136-0263-04	B070000		7	.SOCKET,PIN TERM:U/W 0.025 SQ PIN	22526	75377-001
	136-0269-02	B070000	B093729	1	.SKT,PL-IN ELEK:MICROCKT,14 DIP,PCB MT	09922	D1LB14P-108T
	136-0728-00	B093730		1	.SKT,PL-IN ELEK:MICROCKT,14 CONTACT	09922	D1LB14P-108
	136-0514-00	B070000	B093729	2	.SKT,PL-IN ELEK:MICROCIRCUIT,8 DIP	09922	D1LB8P-108
-88	136-0350-00	B010100	B049999	16	.SKT,PL-IN ELEK:TRANSISTOR,3 CONTACT	80009	136-0350-00
-89	214-0579-00			4	.TERM,TEST POINT:BRS CD PL	80009	214-0579-00
-90	343-0088-00			2	.CLAMP,CABLE:0.062 DIA,PLASTIC	80009	343-0088-00
-91	361-0238-00			3	.SPACER,POST:0.433 L,0.25 OD	80009	361-0238-00
	426-1337-00	B070000		1	.FRAME,MICROCKT:1.22 CM	80009	426-1337-00
					(ATTACHING PARTS)		
	211-0259-00	B070000		4	.SCR,ASSEM WSHR:2-56 X 0.437,PNH,STL,POZ	01536	4821-00021
					(END ATTACHING PARTS)		
	131-1923-00	B070000		1	.CONTACT,ELEC:MICROCIRCUIT	80009	131-1923-00
	220-0797-00	B070000		4	.NUT,CAPTIVE:2-56 X 0.218 DIA,STL CD PL	46384	KF2-256 CC
-92	-----			1	CKT BOARD ASSY:DELAYED TRIGGER(SEE A9 REPL)		
					(ATTACHING PARTS)		
-93	211-0155-00			3	SCREW,EXT RLV:4-40 X 0.375,PNH,SST,POZ	80009	211-0155-00
					(END ATTACHING PARTS)		
					CKT BOARD ASSY INCLUDES:		
-94	131-0608-00			13	.TERMINAL,PIN:0.365 L X 0.025 BRZ GLD PL	22526	48283-036
-95	131-1003-00	B010100	B069999	5	.CONN,RCPT,ELEC:CKT BD MT,3 PRONG	80009	131-1003-00
	131-1003-00	B070000		3	.CONN,RCPT,ELEC:CKT BD MT,3 PRONG	80009	131-1003-00
-96	136-0252-04	B010100	B069999	95	.SOCKET,PIN TERM:U/W 0.016-0.018 DIA PINS	22526	75060-007
	136-0252-07	B070000		44	.SOCKET,PIN CONN:W/O DIMPLE	22526	75060-012
-97	136-0263-04			4	.SOCKET,PIN TERM:U/W 0.025 SQ PIN	22526	75377-001
-98	136-0350-00	B010100	B029999	9	.SKT,PL-IN ELEK:TRANSISTOR,3 CONTACT	80009	136-0350-00
	136-0350-00	B030000	B049999	8	.SKT,PL-IN ELEK:TRANSISTOR,3 CONTACT	80009	136-0350-00
-99	214-0579-00	B010100	B069999	5	.TERM,TEST POINT:BRS CD PL	80009	214-0579-00
	214-0579-00	B070000		3	.TERM,TEST POINT:BRS CD PL	80009	214-0579-00
	136-0514-00	B070000	B093739	1	.SKT,PL-IN ELEK:MICROCIRCUIT,8 DIP	09922	D1LB8P-108
-100	343-0088-00	B010100	B069999	1	.CLAMP,CABLE:0.062 DIA,PLASTIC	80009	343-0088-00
-101	361-0238-00			3	.SPACER,POST:0.433 L,0.25 OD	80009	361-0238-00
	426-1337-00	B070000		1	.FRAME,MICROCKT:1.22 CM	80009	426-1337-00
					(ATTACHING PARTS)		
	211-0259-00	B070000		4	.SCR,ASSEM WSHR:2-56 X 0.437,PNH,STL,POZ	01536	4821-00021
					(END ATTACHING PARTS)		
	131-1923-00	B070000		1	.CONTACT,ELEC:MICROCIRCUIT	80009	131-1923-00
	220-0797-00	B070000		4	.NUT,CAPTIVE:2-56 X 0.218 DIA,STL CD PL	46384	KF2-256 CC
					CKT BOARD ASSY:TIME/CM,INTFC (SEE A12)		
					(ATTACHING PARTS)		
-102	211-0292-00			6	SCR,ASSEM WSHR:4-40 X 0.29,PNH,BRS NI PL	78189	51-040445-01
					(END ATTACHING PARTS)		
-103	-----			1	.CKT BOARD ASSY:MAIN INTERFACE(SEE A6 REPL)		
					(ATTACHING PARTS)		

Replaceable Mechanical Parts - 7B92A

Fig. & Index No.	Tektronix Part No.	Serial/Assembly No. Effective	Discont	Qty	12345 Name & Description	Mfr. Code	Mfr. Part No.
1-104	211-0116-00	B010100	B090824	11	.SCR,ASSEM WSHR:4-40 X 0.312,PNH,BRS,POZ	77900	ORDER BY DESCR
	211-0292-00	B090825		10	.SCR,ASSEM WSHR:4-40 X 0.29,PNH,BRS NI PL .(END ATTACHING PARTS) .CKT BOARD ASSY INCLUDES:	78189	51-040445-01
-105	352-0196-00			4	..HOLDER,RESISTOR:PANEL MOUNT,DELTRIN	80009	352-0196-00
-106	131-0608-00			12	..TERMINAL,PIN:0.365 L X 0.025 BRZ GLD PL	22526	48283-036
-107	136-0252-07			153	..SOCKET,PIN CONN:W/O DIMPLE	22526	75060-012
-108	214-0579-00			4	..TERM,TEST POINT:BRS CD PL	80009	214-0579-00
-109	131-0595-00			2	..TERMINAL,PIN:1.37 L X 0.025 SQ BRS TIN PL	80009	131-0595-00
-110	131-0604-00			38	..CONTACT,ELEC:CKT BD SW,SPR,CU BE	80009	131-0604-00
-111	136-0514-00	B010100	B093729	3	..SKT,PL-IN ELEK:MICROCIRCUIT,8 DIP	09922	DILB8P-108
-112	131-0566-00			5	..BUS,CONDUCTOR:DUMMY RES,0.094 OD X 0.225 L	24546	OMA 07
-113	351-0186-00			4	..POST,CKT BD MTG:0.84 L X 0.25 OD,BRS	80009	351-0186-00
-114	351-0185-00			4	..POST,CKT BD MTG:0.65 L X 0.25 OD BRS	80009	351-0185-00
-115	131-1003-00			3	..CONN,RCPT,ELEC:CKT BD MT,3 PRONG	80009	131-1003-00
-116	352-0274-00			2	..HOLDER,TERMINAL:8 SQUARE PINS	80009	352-0274-00
-117	351-0188-00			2	..POST,CKT BD MTG:0.65 INCH LONG	80009	351-0188-00
-118	136-0350-00	B010100	B049999	42	..SKT,PL-IN ELEK:TRANSISTOR,3 CONTACT	80009	136-0350-00
	131-0590-00			8	..TERMINAL,PIN:0.71 L X 0.025 SQ PH BRZ	22526	47331
	131-0592-00	B010100	B069999	40	..TERMINAL,PIN:0.885 L X 0.025 SQ BRS	22526	47333
	131-0592-00	B070000		39	..TERMINAL,PIN:0.885 L X 0.025 SQ BRS	22526	47333
	131-0595-00	B070000		1	..TERMINAL,PIN:1.37 L X 0.025 SQ BRS TIN PL	80009	131-0595-00
	131-0593-00			10	..TERMINAL,PIN:1.15 L X 0.025 SQ BRS TIN PL	22526	47334
-119	-----			1	.CKT BOARD ASSY:READOUT(SEE A12 REPL) .(ATTACHING PARTS)		
-120	211-0116-00	B010100	B090824	8	.SCR,ASSEM WSHR:4-40 X 0.312,PNH,BRS,POZ	77900	ORDER BY DESCR
	211-0292-00	B090825		8	.SCR,ASSEM WSHR:4-40 X 0.29,PNH,BRS NI PL .(END ATTACHING PARTS)	78189	51-040445-01
-121	131-0604-00			15	..CONTACT,ELEC:CKT BD SW,SPR,CU BE	80009	131-0604-00
	136-0263-04			10	..SOCKET,PIN TERM:U/W 0.025 SQ PIN	22526	75377-001
-122	214-1136-00			1	..ACTUATOR,SL SW:VARIABLE CAL	80009	214-1136-00
-123	-----			1	..SWITCH,SLIDE:(SEE S800 REPL)		
-124	351-0180-00			1	..GUIDE,SLIDE SW:SWITCH ACTUATOR	80009	351-0180-00
-125	129-0323-00	B010100	B020199	1	..SPACER,POST:1.0 L,4-40 EA END,AL,0.25 HEX	80009	129-0323-00
	129-0570-00	B020200		1	..SPACER,POST:0.976 L,4-40 INT EA END,BRS, ..0.188 HEX ..(ATTACHING PARTS)	80009	129-0570-00
-126	211-0008-00			1	..SCREW,MACHINE:4-40 X 0.25,PNH,STL ..(END ATTACHING PARTS)	93907	ORDER BY DESCR
-127	384-1275-00			1	..EXTENSION SHAFT:10.95 L X 0.125 OD,STEEL	80009	384-1275-00
-128	214-1190-02			1	..CPLG,SHAFT,RGD:0.125 OD TO 0.081 OD,AL	80009	214-1190-02
-129	-----			1	.RES.,VARIABLE:(SEE R755 REPL) ..(ATTACHING PARTS)		
-130	210-0583-00			1	..NUT,PLAIN,HEX:0.25-32 X 0.312,BRS CD PL	73743	2X-20319-402
-131	210-0940-00			1	..WASHER,FLAT:0.25 ID X 0.375 OD X 0.02,STL	12327	ORDER BY DESCR
-132	210-0046-00			1	..WASHER,LOCK:0.261 ID,INTL,0.018 THK,STL ..(END ATTACHING PARTS)	77900	1214-05-00-0541C
-133	407-0803-00			1	..BRACKET,ELEC SW:BRASS	80009	407-0803-00
-134	200-1255-00			2	..COVER,CAM SW:24 ELEMENTS	80009	200-1255-00
	334-3448-00	B076289		2	..MARKER,IDENT:MARKED NOTICE	07416	ORDER BY DESCR
-135	210-0406-00			4	..NUT,PLAIN,HEX:4-40 X 0.188,BRS CD PL	73743	12161-50
-136	200-1256-00			2	..COVER,CAM SW:28 ELEMENTS	80009	200-1256-00
-137	210-0406-00			4	..NUT,PLAIN,HEX:4-40 X 0.188,BRS CD PL	73743	12161-50
	210-1261-00	B076322		2	..WASHER,FLAT:0.325 ID X 0.5 OD X 0.05,NYLON	11897	167-NN-Q627
-138	376-0129-01			1	..SPOOL,SW ACTR:0.128 & 0.203 ID,AL	80009	376-0129-01
	263-1084-00			1	..SW CAM ACTR AS:TIME/DIV OR DELAY TIME	80009	263-1084-00
-139	384-0806-00			1	..SHAFT,CAM SW:9.75 L X 0.125 OD INNER ..CONCENTRIC,W/DRIVER	80009	384-0806-00
	210-1261-00	B076322		2	..WASHER,FLAT:0.325 ID X 0.5 OD X 0.05,NYLON	11897	167-NN-Q627
-140	131-0963-00			1	..CONTACT,ELEC:GROUNDING,PH BRZ,W/BRACKET ..(CONTACT NOW PART OF A6 ONLY)	TK0507	ORDER BY DESCR
-141	214-1139-02			1	..SPRING,FLAT:0.885 X 0.156 CU BE GRN CLR	80009	214-1139-02
	214-1139-03			1	..SPRING,FLAT:0.885 X 0.156 CU BE RED CLR	80009	214-1139-03
-142	214-1127-00			2	..ROLLER,DETENT:0.125 DIA X 0.125,SST	80009	214-1127-00
-143	210-0406-00			3	..NUT,PLAIN,HEX:4-40 X 0.188,BRS CD PL	73743	12161-50
-144	401-0081-02			1	..BEARING,CAM SW:FRONT W/O MOUNTING BOSSES ..(ATTACHING PARTS)	80009	401-0081-02
-145	354-0391-00			1	..RING,RETAINING:BASIC EXT,U/O 0.438 DIA SFT	79136	5100-43 MD

Fig. & Index No.	Tektronix Part No.	Serial/Assembly No.		Qty	12345 Name & Description	Mfr.	
		Effective	Dscont			Code	Mfr. Part No.
1-					..(END ATTACHING PARTS)		
-146	105-0601-00	B010100	B062409	1	..ACTUATOR,CAM SW:TIME/CM,FRONT	80009	105-0601-00
	105-0601-01	B062410		1	..ACTUATOR,CAM SW:TIME/CM,FRONT	80009	105-0601-01
	210-0406-00			4	..NUT,PLAIN,HEX:4-40 X 0.188,BRS CD PL	73743	12161-50
-147	401-0083-00			1	..BEARING,CAM SW:CENTER 0.83 DIA CAM DOUBLE ..CKT BD	80009	401-0083-00
-148	105-0600-00	B010100	B062409	1	..ACTUATOR,CAM SW:TIME/CM,REAR	80009	105-0600-00
	105-0600-01	B062410		1	..ACTUATOR,CAM SW:TIME/CM,REAR	80009	105-0600-01
-149	214-1139-02			1	..SPRING,FLAT:0.885 X 0.156 CU BE GRN CLR	80009	214-1139-02
	214-1139-03			1	..SPRING,FLAT:0.885 X 0.156 CU BE RED CLR	80009	214-1139-03
-150	214-1127-00			2	..ROLLER,DETENT:0.125 DIA X 0.125,SST	80009	214-1127-00
-151	210-0406-00			4	..NUT,PLAIN,HEX:4-40 X 0.188,BRS CD PL	73743	12161-50
-152	401-0081-02			1	..BEARING,CAM SW:FRONT W/O MOUNTING BOSSES ..(ATTACHING PARTS)	80009	401-0081-02
-153	354-0391-00			1	..RING,RETAINING:BASIC EXT,U/O 0.438 DIA SFT ..(END ATTACHING PARTS)	79136	5100-43 MD
-154	220-0547-01			3	NUT BLOCK:4-40 X 0.282,NI SIL NP (ATTACHING PARTS)	80009	220-0547-01
-155	211-0105-00			3	SCREW,MACHINE:4-40 X 0.188,FLH,100 DEG	TK0435	ORDER BY DESC
-156	214-1061-00			1	CONTACT,ELEC:GROUNDING,CU BE	80009	214-1061-00
-157	426-0505-11			1	FR SECT,PLUG-IN:TOP	80009	426-0505-11
-158	214-1054-00			1	SPRING,FLAT:0.825 X 0.322,SST	TK1326	ORDER BY DESC
-159	105-0075-00			1	BOLT,LATCH:	80009	105-0075-00
	220-0547-01			3	NUT BLOCK:4-40 X 0.282,NI SIL NP (ATTACHING PARTS)	80009	220-0547-01
-160	211-0105-00			3	SCREW,MACHINE:4-40 X 0.188,FLH,100 DEG (END ATTACHING PARTS)	TK0435	ORDER BY DESC
-161	426-0499-11			1	FR SECT,PLUG-IN:BOTTOM	80009	426-0499-11
-162	131-0993-00			1	BUS,CONDUCTOR:SHUNT ASSEMBLY,BLACK	22526	65474-005
-163	276-0614-00			5	CORE,EM:TOROID,FERRITE	78488	57-1656
	276-0635-00			1	CORE,EM:TOROID,FERRITE	02114	768 T188/3E2A
	198-2952-00			1	WIRE SET,ELEC: (A7P701,A7P760)	80009	198-2952-00
	175-0529-00			AR	..WIRE,ELEC:STRD,26 AWG,300V RMS,WHITE,PVC ..(0.125 FT REQUIRED)	71124	11715-000-T-127
	131-0707-00			6	..CONTACT,ELEC:22-26 AWG,BRS,CU BE GLD PL	22526	47439-000
-164	352-0164-01	B075710		1	..HLDR,TERM CONN:6 WIRE,BROWN	80009	352-0164-01
	198-3997-00			1	WIRE SET,ELEC:	80009	198-3997-00
	175-2623-00			1	..CA ASSY,SP,ELEC:2,26 AWG,3.0 L,RIBBON ..(FROM A4P110 TO DS820)	TK1375	ORDER BY DESC
-165	175-0825-00			AR	..CABLE,SP,ELEC:2,26 AWG,STRD,PVC JKT,RBN ..(0.270 FT REQUIRED)	80009	175-0825-00
-166	131-0707-00			2	..CONTACT,ELEC:22-26 AWG,BRS,CU BE GLD PL	22526	47439-000
-167	352-0169-00			1	..HLDR,TERM CONN:2 WIRE,BLACK	80009	352-0169-00
	175-5576-00			1	..CA ASSY,SP,ELEC:6,26 AWG,5.5 L,RIBBON ..(FROM A8P105 TO R100,R113)	80009	175-5576-00
-168	175-0829-00			AR	..CABLE,SP,ELEC:6,26 AWG,STRD,PVC JKT,RBN ..(0.500 FT REQUIRED)	08261	111-2699-973
	131-0707-00			6	..CONTACT,ELEC:22-26 AWG,BRS,CU BE GLD PL	22526	47439-000
	352-0164-08			1	..HLDR,TERM CONN:6 WIRE,GRAY	80009	352-0164-08
	175-5577-00			1	..CA ASSY,SP,ELEC:5,26 AWG,14.0 L,RIBBON ..(FROM A9P204,A5P214 TO R250)	80009	175-5577-00
-169	175-0828-00			AR	..CABLE,SP,ELEC:5,26 AWG,STRD,PVC JKT,RBN ..(1.188 FT REQUIRED)	08261	111-2699-955
	131-0707-00			6	..CONTACT,ELEC:22-26 AWG,BRS,CU BE GLD PL	22526	47439-000
-170	352-0163-04			1	..HLDR,TERM CONN:5 WIRE,YELLOW	80009	352-0163-04
-171	352-0171-02			1	..HLDR,TERM CONN:1 WIRE,RED	80009	352-0171-02
	175-5578-00			1	..CA ASSY,SP,ELEC:6,26 AWG,9.5 L,RIBBON ..(FROM A6P928 TO R750,R930)	80009	175-5578-00
	175-0829-00			AR	..CABLE,SP,ELEC:6,26 AWG,STRD,PVC JKT,RBN ..(0.813 FT REQUIRED)	08261	111-2699-973
	131-0707-00			7	..CONTACT,ELEC:22-26 AWG,BRS,CU BE GLD PL	22526	47439-000
	352-0164-05			1	..HLDR,TERM CONN:6 WIRE,GREEN	80009	352-0164-05
	352-0171-05			1	..HLDR,TERM CONN:1 WIRE,GREEN	80009	352-0171-05
	175-5579-00			1	..CA ASSY,SP,ELEC:3,26 AWG,7.75 L,RIBBON ..(FROM A6P947 TO R490)	80009	175-5579-00
-172	175-0826-00			AR	..CABLE,SP,ELEC:3,26 AWG,STRD,PVC JKT,RBN ..(0.667 FT REQUIRED)	80009	175-0826-00

Replaceable Mechanical Parts - 7B92A

Fig. & Index No.	Tektronix Part No.	Serial/Assembly No.		Qty	12345 Name & Description	Mfr.	
		Effective	Discort			Code	Mfr. Part No.
1- -173	131-0707-00			3	..CONTACT,ELEC:22-26 AWG,BRS,CU BE GLD PL	22526	47439-000
	352-0161-07			1	..HLDR,TERM CONN:3 WIRE,VIOLET	80009	352-0161-07
	175-5580-00			1	..CA ASSY,SP,ELEC:2,26 AWG,3.0 L,RIBBON ..(FROM A6P936 TO R250)	80009	175-5580-00
	175-0825-00			AR	..CABLE,SP,ELEC:2,26 AWG,STRD,PVC JKT,RBN ..(0.271 FT REQUIRED)	80009	175-0825-00
	131-0707-00			2	..CONTACT,ELEC:22-26 AWG,BRS,CU BE GLD PL	22526	47439-000
	352-0169-06			1	..HLDR,TERM CONN:2 WIRE,BLUE	80009	352-0169-06
	175-5581-00			1	..CA ASSY,SP,ELEC:5,26 AWG,10.0 L,RIBBON ..(FROM A7P603 TO R600,R605,R615)	80009	175-5581-00
	175-0828-00			AR	..CABLE,SP,ELEC:5,26 AWG,STRD,PVC JKT,RBN ..(0.854 FT REQUIRED)	08261	111-2699-955
	131-0707-00			5	..CONTACT,ELEC:22-26 AWG,BRS,CU BE GLD PL	22526	47439-000
	352-0163-03			1	..HLDR,TERM CONN:5 WIRE,ORANGE	80009	352-0163-03
	195-1049-00			1	..LEAD,ELECTRICAL:26 AWG,3.5 L,9-2	80009	195-1049-00
	131-0707-00			1	..CONTACT,ELEC:22-26 AWG,BRS,CU BE GLD PL	22526	47439-000
	195-5605-00			1	..LEAD,ELECTRICAL:26 AWG,2.5 L,9-6	80009	195-5605-00
	131-0707-00			1	..CONTACT,ELEC:22-26 AWG,BRS,CU BE GLD PL	22526	47439-000
	195-5606-00			1	..LEAD,ELECTRICAL:26 AWG,3.0 L,9-1	80009	195-5606-00
131-0707-00			2	..CONTACT,ELEC:22-26 AWG,BRS,CU BE GLD PL	22526	47439-000	
352-0169-02			1	..HLDR,TERM CONN:2 WIRE,RED	80009	352-0169-02	
352-0169-04			1	..HLDR,TERM CONN:2 WIRE,YELLOW ..(FROM A5P126 TO R250,R50)	80009	352-0169-04	
198-2253-00			1	WIRE SET,ELEC:	80009	198-2253-00	
175-3092-00			1	..CA ASSY,SP,ELEC:4,26 AWG,3.0 L ..(FROM A5P212 TO A9P202)	80009	175-3092-00	
-174	175-0827-00			AR	..CABLE,SP,ELEC:4,26 AWG,STRD,PVC JKT,RBN ..(0.271 FT REQUIRED)	08261	111-2699-954
-175	131-0707-00			8	..CONTACT,ELEC:22-26 AWG,BRS,CU BE GLD PL	22526	47439-000
	352-0162-02			2	..HLDR,TERM CONN:4 WIRE,RED	80009	352-0162-02
	175-3511-00			1	..CA ASSY,SP,ELEC:6,26 AWG,4.5 L,RIBBON ..(FROM A3P113 TO A8P103)	80009	175-3511-00
	175-0829-00			AR	..CABLE,SP,ELEC:6,26 AWG,STRD,PVC JKT,RBN ..(0.396 FT REQUIRED)	08261	111-2699-973
	131-0707-00			12	..CONTACT,ELEC:22-26 AWG,BRS,CU BE GLD PL	22526	47439-000
	352-0164-03			2	..HLDR,TERM CONN:6 WIRE,ORANGE	80009	352-0164-03
	175-6054-00			1	..CA ASSY,SP,ELEC:2,26 AWG,3.5 L,RIBBON ..(FROM A1P121 TO A3P117)	80009	175-6054-00
	175-0825-00			AR	..CABLE,SP,ELEC:2,26 AWG,STRD,PVC JKT,RBN ..(0.313 FT REQUIRED)	80009	175-0825-00
	131-0707-00			4	..CONTACT,ELEC:22-26 AWG,BRS,CU BE GLD PL	22526	47439-000
	352-0169-07			2	..HLDR,TERM CONN:2 WIRE,VIOLET	80009	352-0169-07
	175-6055-00			1	..CA ASSY,SP,ELEC:4,26 AWG,3.25 L,RIBBON ..(FROM A8P101 TO A9P201)	80009	175-6055-00
	175-0827-00			AR	..CABLE,SP,ELEC:4,26 AWG,STRD,PVC JKT,RBN ..(0.292 FT REQUIRED)	08261	111-2699-954
	131-0707-00			8	..CONTACT,ELEC:22-26 AWG,BRS,CU BE GLD PL	22526	47439-000
	352-0162-01			2	..HLDR,TERM CONN:4 WIRE,BROWN	80009	352-0162-01
	175-6056-00			1	..CA ASSY,SP,ELEC:5,26 AWG,6.25 L,RIBBON ..(FROM A4P832 TO A7P822)	80009	175-6056-00
175-0828-00			AR	..CABLE,SP,ELEC:5,26 AWG,STRD,PVC JKT,RBN ..(0.542 FT REQUIRED)	08261	111-2699-955	
131-0707-00			10	..CONTACT,ELEC:22-26 AWG,BRS,CU BE GLD PL	22526	47439-000	
352-0163-02			2	..HLDR,TERM CONN:5 WIRE,RED	80009	352-0163-02	
175-6057-00			1	..CA ASSY,SP,ELEC:5,26 AWG,7.0 L,RIBBON ..(FROM A4P811 TO A7P801)	80009	175-6057-00	
175-0828-00			AR	..CABLE,SP,ELEC:5,26 AWG,STRD,PVC JKT,RBN ..(0.604 FT REQUIRED)	08261	111-2699-955	
131-0707-00			10	..CONTACT,ELEC:22-26 AWG,BRS,CU BE GLD PL	22526	47439-000	
352-0163-01			2	..HLDR,TERM CONN:5 WIRE,BROWN	80009	352-0163-01	
175-6058-00			1	..CABLE ASSY,RF:50 OHM COAX,8.75 L,9-2 ..(FROM A9J280 TO A6J485)	80009	175-6058-00	
175-6060-00			1	..CABLE ASSY,RF:50 OHM COAX,3.5 L,9-5 ..(FROM A9J290 TO A1J128)	80009	175-6060-00	
175-6061-00			1	..CABLE ASSY,RF:50 OHM COAX,4.5 L,9-6 ..(FROM A8J180 TO A1J129)	80009	175-6061-00	
175-6081-00			1	..CABLE ASSY,RF:50 OHM COAX,10.5 L,9-4 ..(FROM A8J150 TO A6J35)	80009	175-6081-00	

Fig. & Index No.	Tektronix Part No.	Serial/Assembly No.		Qty	12345	Name & Description	Mfr.	
		Effective	Dscont				Code	Mfr. Part No.
1-	195-6882-00			1		.(FROM A9J250 TO A6J25) .LEAD,ELECTRICAL:26 AWG,3.0 L,9-1	80009	195-6882-00
	131-0707-00			2		.(FROM A3P112 TO A8P102) ..CONTACT,ELEC:22-26 AWG,BRS,CU BE GLD PL	22526	47439-000
	352-0171-02			2		..HLDR,TERM CONN:1 WIRE,RED	80009	352-0171-02
	195-6883-00			1		.LEAD,ELECTRICAL:26 AWG,3.0 L,9-1 .(FROM A6P911 TO S490)	80009	195-6883-00
	131-0707-00			1		..CONTACT,ELEC:22-26 AWG,BRS,CU BE GLD PL	22526	47439-000
	352-0171-01			1		..HLDR,TERM CONN:1 WIRE,BROWN	80009	352-0171-01
						STANDARD ACCESSORIES		
	070-1752-01			1		MANUAL,TECH:OPERATORS	80009	070-1752-01
	070-1751-02			1		MANUAL,TECH:INSTRUCTIONS	80009	070-1751-02

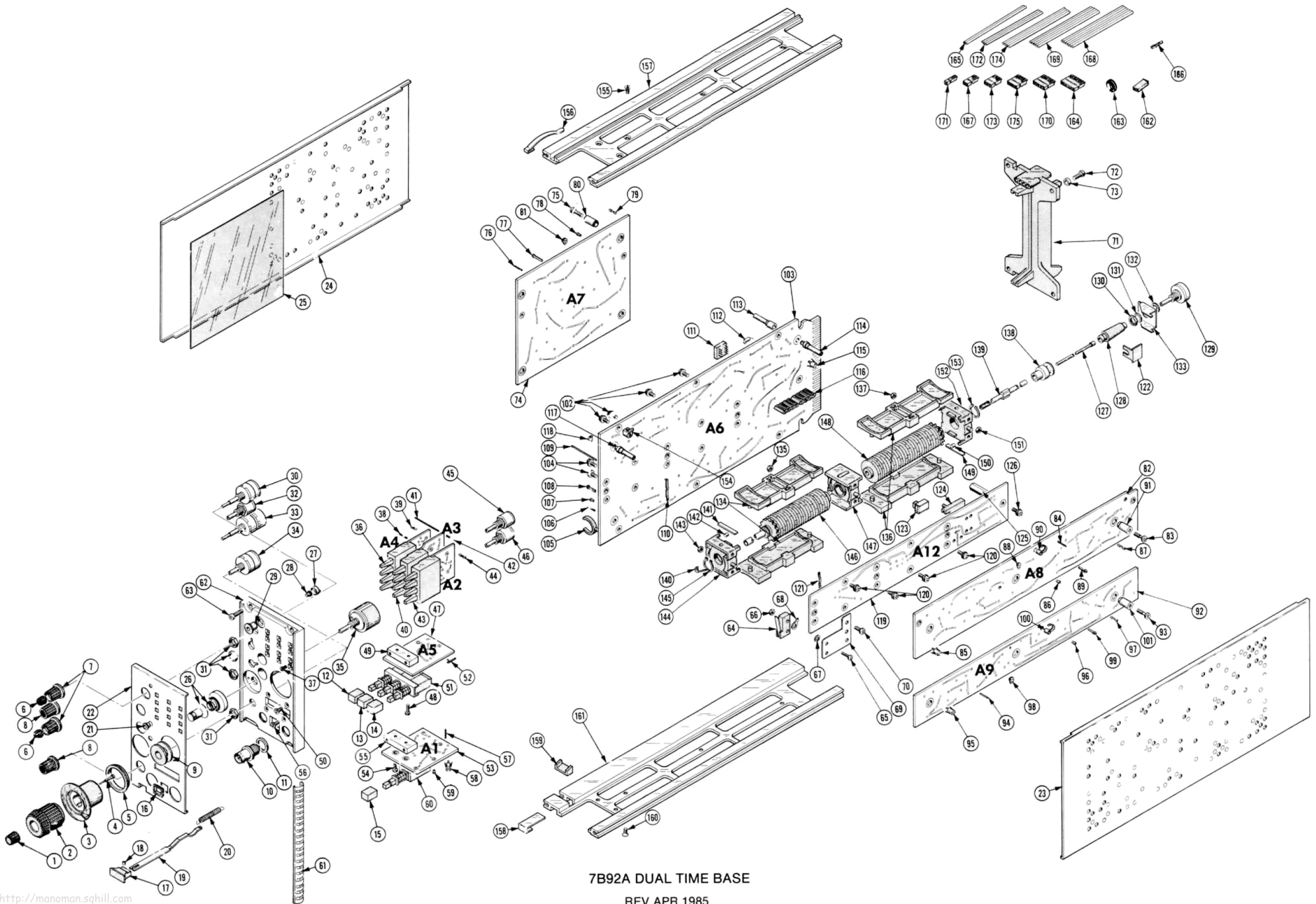

7B92A DUAL TIME BASE

REV APR 1985

MANUAL CHANGE INFORMATION

At Tektronix, we continually strive to keep up with latest electronic developments by adding circuit and component improvements to our instruments as soon as they are developed and tested.

Sometimes, due to printing and shipping requirements, we can't get these changes immediately into printed manuals. Hence, your manual may contain new change information on following pages.

A single change may affect several sections. Since the change information sheets are carried in the manual until all changes are permanently entered, some duplication may occur. If no such change pages appear following this page, your manual is correct as printed.

DESCRIPTION

PG. 42

THESE CHANGES ARE EFFECTIVE AT SN B075620

MECHANICAL PARTS LIST CHANGES

REMOVE:

FIG.	PART NO.	QTY.	DESCRIPTION
1-73	361-0326-00	1	SPACER,SLEEVE:0.1 L X 0.18 ID,AL

Date: 1/27/87 Change Reference: M61067

Product: 7B92A DUAL TIME BASE Manual Part No.: 070-1751-02

DESCRIPTION Product Group 42

This change is effective at serial number B099300.

REPLACEABLE ELECTRICAL PARTS LIST CHANGES

CHANGE TO:

R755 311-2371-00 RES.,VAR, NONWW:PNL,10K OHM,0.5W

R755 is shown on Fig. 8-17 A12-Readout Circuit Board.

Tektronix[®] MANUAL CHANGE INFORMATION

COMMITTED TO EXCELLENCE

Date: 12/15/87 Change Reference: M60204

Product: 7B92A Dual Time Base

Manual Part No.: 070-1751-02

PRODUCT GROUP CODE: 42

DESCRIPTION

These changes are effective at serial number B099634.

MECHANICAL PARTS LIST CHANGE

CHANGE TO:

FIG. &
INDEX
NO.

1-71

386-5466-00

PANEL, REAR